

172165-1 ✓ ACTIVE



MATE-N-LOK | Mini-Universal MATE-N-LOK

TE Internal #: 172165-1

Rectangular Power Connectors, Housing, Plug, Wire-to-Wire, 2 Position, 4.2 mm [.165 in] Centerline, Wire & Cable, UL 94V-0, Mini-Universal MATE-N-LOK

[View on TE.com >](#)

Connectors > Power Connectors > Rectangular Power > Rectangular Power Connectors



Rectangular Power Connector Type: **Housing**

Connector & Housing Type: **Plug**

Connector System: **Wire-to-Wire**

Number of Positions: **2**

Centerline (Pitch): **4.2 mm [.165 in]**

Features

Product Type Features

Rectangular Power Connector Type	Housing
Connector & Housing Type	Plug
Connector System	Wire-to-Wire
Sealable	No
Connector & Contact Terminates To	Wire & Cable

Configuration Features

Number of Positions	2
Number of Power Positions	0
Number of Signal Positions	0
Number of Rows	1

Electrical Characteristics

Operating Voltage	600 VDC
-------------------	---------

Contact Features

Multiple Contact Types	Without
------------------------	---------



Contact Layout	Inline
----------------	--------

Contact Retention Within Housing	Without
----------------------------------	---------

Contact Type	Socket
--------------	--------

Termination Features

Termination Method to Wire & Cable	Crimp
------------------------------------	-------

Mechanical Attachment

Panel Mount Feature	Without
---------------------	---------

Connector Mounting Type	Cable Mount (Free-Hanging)
-------------------------	----------------------------

Housing Features

Centerline (Pitch)	4.2 mm [.165 in]
--------------------	------------------

Housing Color	Natural
---------------	---------

Housing Material	Nylon 66
------------------	----------

Usage Conditions

Operating Temperature Range	-20 – 105 °C [-4 – 221 °F]
-----------------------------	----------------------------

Operation/Application

Circuit Application	Power & Signal
---------------------	----------------

Industry Standards

CSA Rating	Certified, LR 7189
------------	--------------------

UL Rating	Recognized
-----------	------------

Agency/Standard	CSA, UL
-----------------	---------

Approved Standards	UL E28476
--------------------	-----------

UL Flammability Rating	UL 94V-0
------------------------	----------

Glow Wire Rating	Standard Part - Not Glow Wire
------------------	-------------------------------

Packaging Features

Packaging Quantity	1000
--------------------	------

Packaging Method	Bag
------------------	-----

Product Compliance

[For compliance documentation, visit the product page on TE.com>](#)

EU RoHS Directive 2011/65/EU	Compliant
------------------------------	-----------

EU ELV Directive 2000/53/EC	Compliant
-----------------------------	-----------







China RoHS 2 Directive MIIT Order No 32, 2016	No Restricted Materials Above Threshold
EU REACH Regulation (EC) No. 1907/2006	Current ECHA Candidate List: JUNE 2023 (235) Candidate List Declared Against: JUNE 2023 (235) Does not contain REACH SVHC
Halogen Content	Low Halogen - Br, Cl, F, I < 900 ppm per homogenous material. Also BFR/CFR/PVC Free
Solder Process Capability	Not applicable for solder process capability

Product Compliance Disclaimer

This information is provided based on reasonable inquiry of our suppliers and represents our current actual knowledge based on the information they provided. This information is subject to change. The part numbers that TE has identified as EU RoHS compliant have a maximum concentration of 0.1% by weight in homogenous materials for lead, hexavalent chromium, mercury, PBB, PBDE, DBP, BBP, DEHP, DIBP, and 0.01% for cadmium, or qualify for an exemption to these limits as defined in the Annexes of Directive 2011/65/EU (RoHS2). Finished electrical and electronic equipment products will be CE marked as required by Directive 2011/65/EU. Components may not be CE marked. Additionally, the part numbers that TE has identified as EU ELV compliant have a maximum concentration of 0.1% by weight in homogenous materials for lead, hexavalent chromium, and mercury, and 0.01% for cadmium, or qualify for an exemption to these limits as defined in the Annexes of Directive 2000/53/EC (ELV). Regarding the REACH Regulation, the information TE provides on SVHC in articles for this part number is based on the latest European Chemicals Agency (ECHA) 'Guidance on requirements for substances in articles' posted at this URL: <https://echa.europa.eu/guidance-documents/guidance-on-reach>

Compatible Parts

 <p>TE Part # 1-770988-1 MINI UMNL SOK 22-18AWG LP LF</p>	 <p>TE Part # 1-770985-0 MINI UMNL PIN 26-22AWG AU LP</p>	 <p>TE Part # 770966-2 02P MINI UMNL R/A HDR ASSY AU</p>	 <p>TE Part # 1-770987-0 MINI UMNL PIN 22-18 AWG AU LP</p>
 <p>TE Part # 770166-2 02P MINI-UMNL ASSY VO SNAU</p>	 <p>TE Part # 770988-3 MINI UMNL SOK 22-18AWG AU LP</p>	 <p>TE Part # 1-770988-0 MINI UMNL SOK 22-18AWG AU</p>	 <p>TE Part # 1-794059-0 MINI UMNL PIN L/P LF</p>



TE Part # 770988-1
MINI UMNL SOK 22-18AWG SN LP



TE Part # 770986-1
MINI UMNL SOK 26-22AWG SN LP



TE Part # 1-770966-0
02P MINI UMNL R/A HDR ASSY SN



TE Part # 794058-1
MINI UMNL SOK L/P



TE Part # 770166-1
02P MINI-UMNL ASSY VO SNNI*



TE Part # 170365-3
MINI UNIVERSAL M-N-L SOCKET LP



TE Part # 170364-3
MINI UNIVERSAL M-N-L PIN LP



TE Part # 770985-1
MINI UMNL PIN 26-22AWG SN LP



TE Part # 1-794407-1
MINI UMNL SOK 20-16 AWG AU LF



TE Part # 171638-1
MINI U-M-N-L PIN CONT. LP



TE Part # 1-770872-0
02P MINI UMNL HDR ASSY SN



TE Part # 171639-1
MINI U-M-N-L SOCKET LP

Also in the Series | Mini-Universal MATE-N-LOK

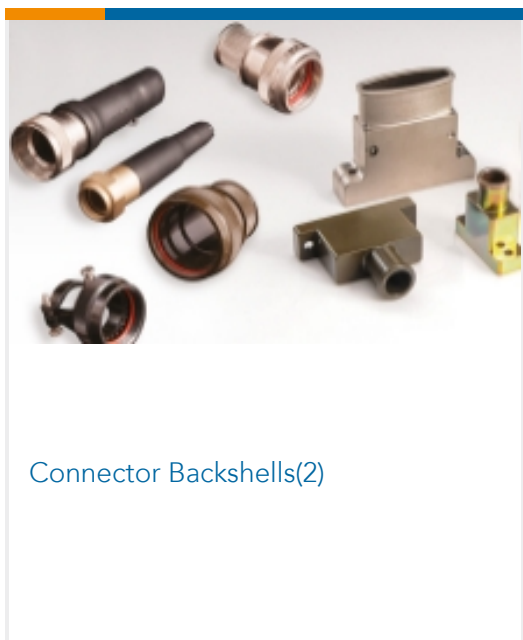

Connector Backshells(2)

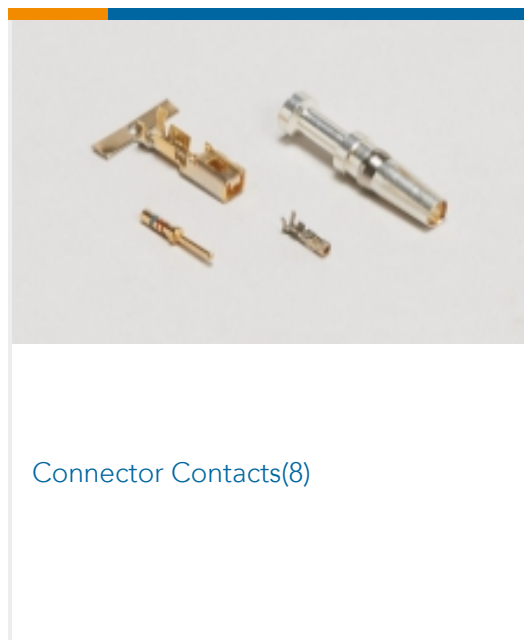

Connector Contacts(8)

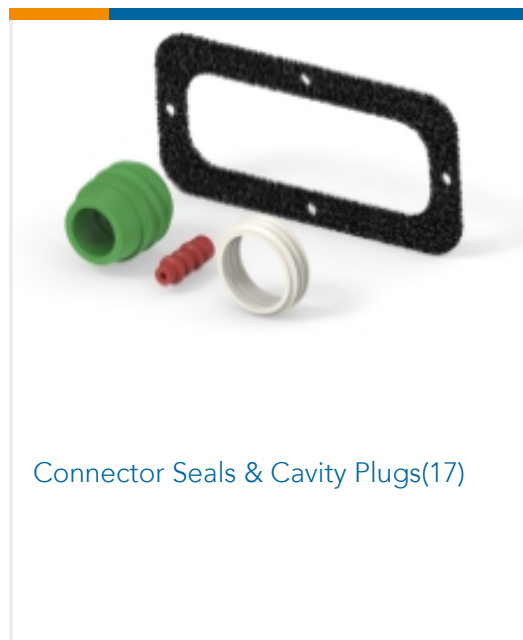

Connector Seals & Cavity Plugs(17)

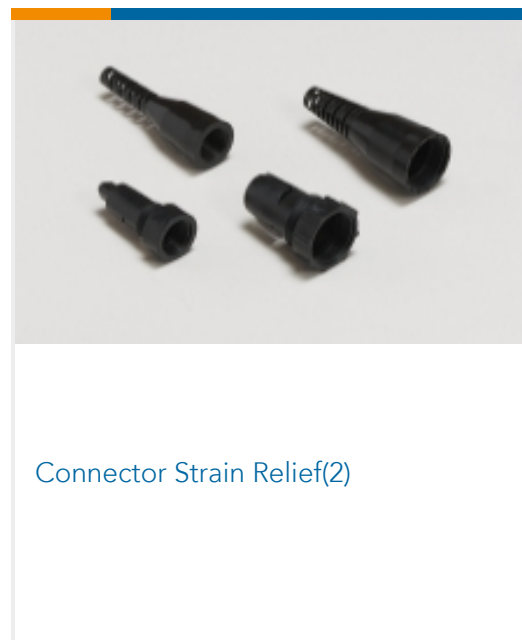

Connector Strain Relief(2)

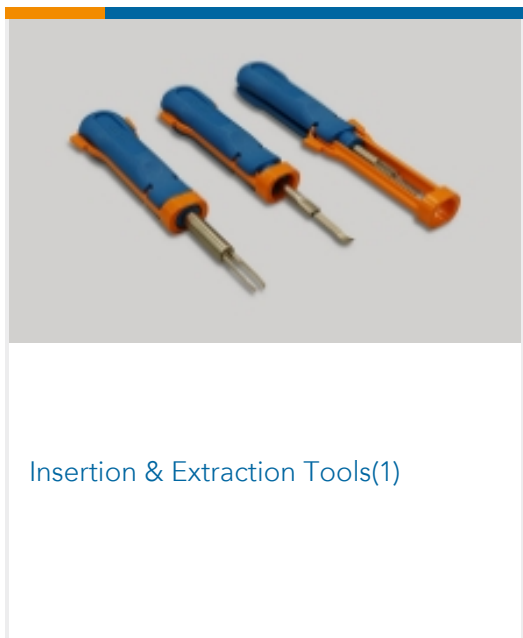

Insertion & Extraction Tools(1)



PCB Headers & Receptacles(1)

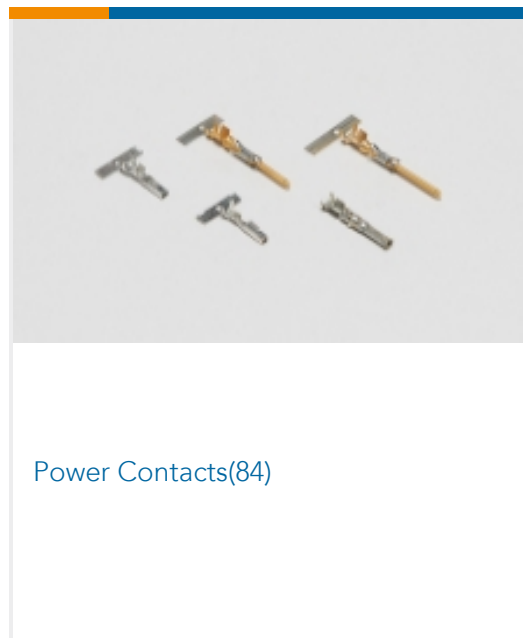

Power Contacts(84)

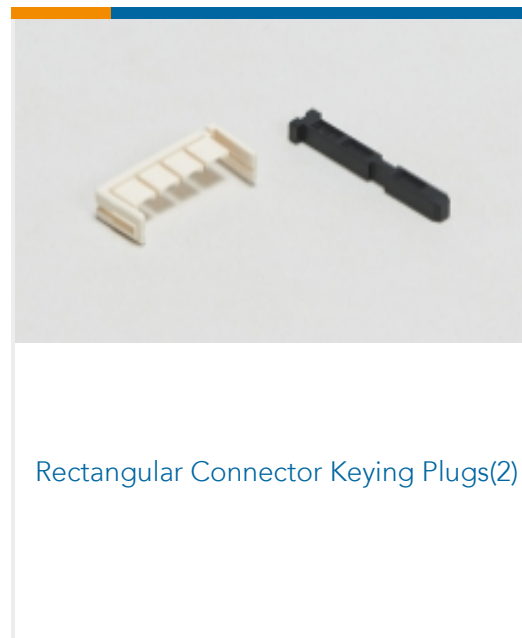

Rectangular Connector Keying Plugs(2)



Rectangular Connector Locking(2)



Rectangular Power Connectors(244)

Customers Also Bought



TE Part #172170-1
12 CIR UNIV M-N-L PLUG



TE Part #171638-1
MINI U-M-N-L PIN CONT. LP



TE Part #172158-1
3 CIR UNIV M-N-L CAP

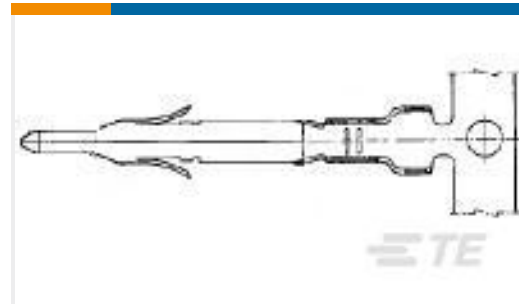

TE Part #170363-1
MINI UNIVERSAL M-N-L PIN LP

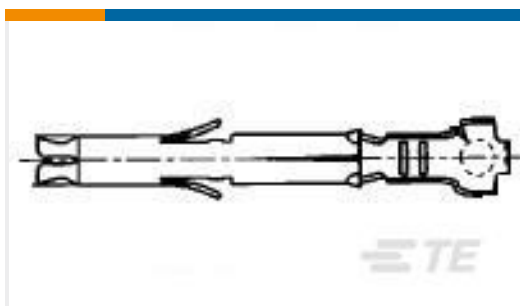

TE Part #170365-1
MINI UNIVERSAL M-N-L SOCKET LP



TE Part #172169-1
9 CIR UNIV M-N-L PLUG



TE Part #172159-1
4 CIR UNIV M-N-L CAP



TE Part #172166-1
3 CIR UNIV M-N-L PLUG



TE Part #172168-1
6 CIR UNIV M-N-L PLUG



TE Part #172160-1
6 CIR UNIV M-N-L CAP

Documents

Product Drawings

[2 CIR UNIV M-N-L PLUG NATL](#)

English

CAD Files

[3D PDF](#)

3D

[Customer View Model](#)

[ENG_CVM_CVM_172165-1_H.2d_dxf.zip](#)



English

Customer View Model

[ENG_CVM_CVM_172165-1_H.3d_igs.zip](#)

English

Customer View Model

[ENG_CVM_CVM_172165-1_H.3d_stp.zip](#)

English

By downloading the CAD file I accept and agree to the [Terms and Conditions](#) of use.

Datasheets & Catalog Pages

[SOFT_SHELL_PIN_AND_SOCKET_CONNECTORS_CATALOG](#)

English

Product Specifications

[Engineering Report](#)

English

Product Environmental Compliance

[Product Compliance Document](#)

English

[Product Compliance Document](#)

English

Instruction Sheets

[Instruction Sheet \(U.S.\)](#)

English

Agency Approvals

[Agency Approval Document](#)

English