

CKT SIZE	DIM A	DIM B
4	.709 (18.00)	.496 (12.60)
5	.874 (22.20)	.661 (16.80)
6	1.039 (26.40)	.827 (21.00)
7	1.205 (30.60)	.992 (25.20)
8	1.370 (34.80)	1.157 (29.40)
9	1.535 (39.00)	1.323 (33.60)
10	1.701 (43.20)	1.488 (37.80)
11	1.866 (47.40)	1.654 (42.00)
12	2.031 (51.60)	1.819 (46.20)

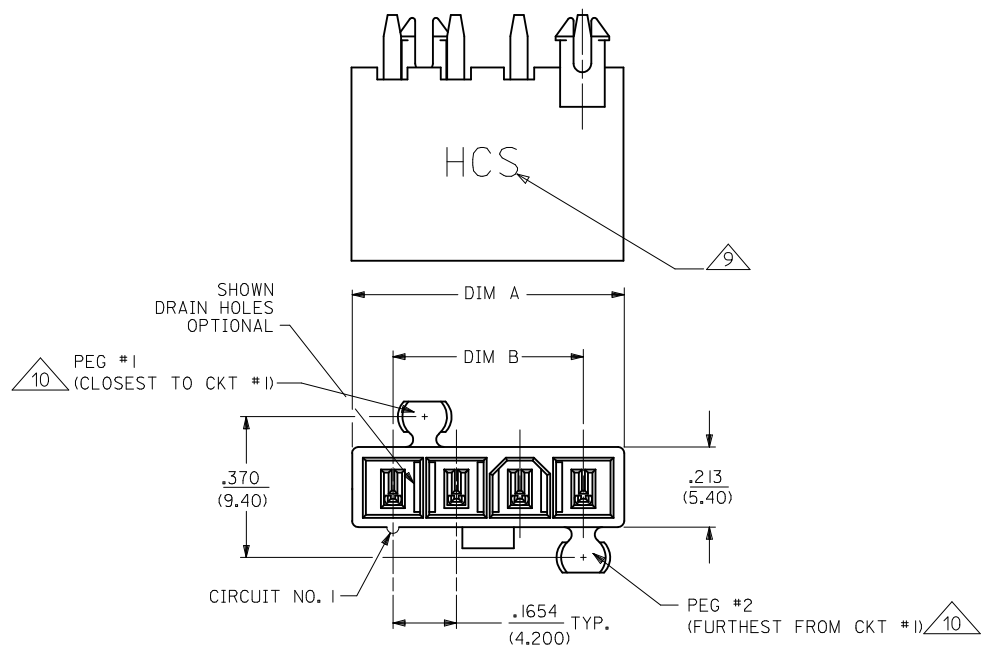

- NOTES:
- MATERIALS:
HOUSING:
1=NYLON 6/6, UL94 V-2, COLOR: NATURAL
2=NYLON 6/6, UL94 V-0, COLOR: NATURAL
3=NYLON 6/6, UL94 V-2, COLOR: BLACK
TERMINALS:
COPPER ALLOY
 - TERMINAL PLATING:
1=.000100/(0.00254) MIN. MATTE TIN OVER
.000050/(0.00127) MIN. NICKEL
2=.000030/(0.00076) MIN. SELECT GOLD AND
.000100/(0.00254) MIN. SELECT MATTE TIN
OVER .000050/(0.00127) MIN. NICKEL OVERALL
 - PRODUCT SPECIFICATION: PS-44476-001
 - PACKAGING: SEE CHARTS
 - PART MATES WITH MINI-FIT JR. RECEPTACLE NO. 5557.
 - PART IS NOT DESIGNED FOR CURRENT SHARING.
 - PARTS ARE NOT TO BE MATED OR UN-MATED WHILE CIRCUITS ARE LIVE.
- 8 44472-2470 ONLY FOR WIDER LOCKING RAMP.
 9 PARTS WILL HAVE "HCS" MARKING.
 10 SEE CHART FOR PARTS WITH PEGS.
 11 PART CONFORMS TO CLASS "B" REQUIREMENTS OF COSMETIC SPECIFICATION PS-45499-002.

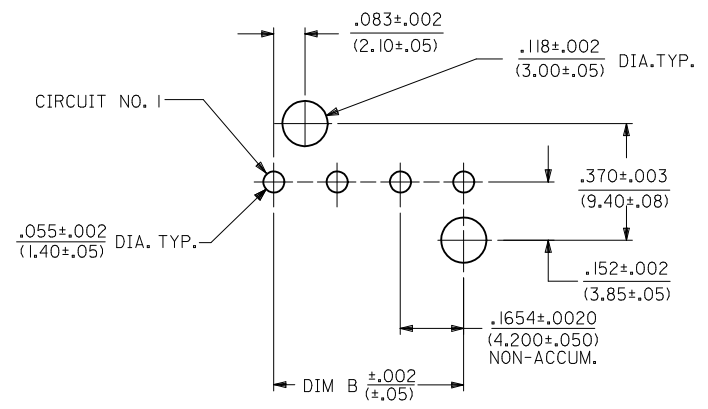
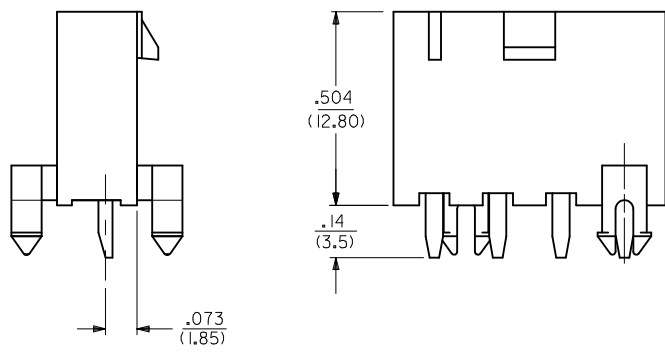

RECOMMENDED HOLE LAYOUT FOR
.070/(1.78) MAX. THICK P. C. BOARD
VIEWED FROM COMPONENT SIDE

LEGEND:
44472 - ** **
CIRCUIT SIZE _____
(04-12 FOR SINGLE ROW)
(02-24 FOR DUAL ROW)
ASSEMBLY VERSION _____
(01 THRU 49 FOR SINGLE ROW)
(50 THRU 99 FOR DUAL ROW)

SEE SHT. 2 FOR DUAL ROW
* THE CHART FOR SINGLE ROW PRODUCT IS ON PAGE 6.

CHANGE PLATING EC NO: UCP2012-1560 DRW: NGUYEN CHKD: J.BELL APPR: FSMITH 2012/01/05 2012/01/05 2012/02/02	QUALITY SYMBOLS ▽=0 ▽=0 ▽=0	GENERAL TOLERANCES (UNLESS SPECIFIED)		DIMENSION STYLE		SCALE	DESIGN UNITS	THIRD ANGLE PROJECTION		
				IN/MM		4:1	METRIC			
				DRAWN BY	DATE	TITLE				
				GEP	1994/07/25	MINI-FIT VERT HDR ASSY W & W/O PEGS/DRAIN HOLES SINGLE AND DUAL ROW				
M REV	DESCRIPTION CHANGE PLATING	DRAWN BY		DATE		MATERIAL NO.		SHEET NO.		
		GEP		1994/07/25		SEE CHARTS		SDA-44472-****		
		CHECKED BY		DATE		DOCUMENT NO.		1 OF 8		
		RJF		1994/07/25						
APPROVED BY		DATE		THIS DRAWING CONTAINS INFORMATION THAT IS PROPRIETARY TO MOLEX INCORPORATED AND SHOULD NOT BE USED WITHOUT WRITTEN PERMISSION						
RJF		1994/07/25								

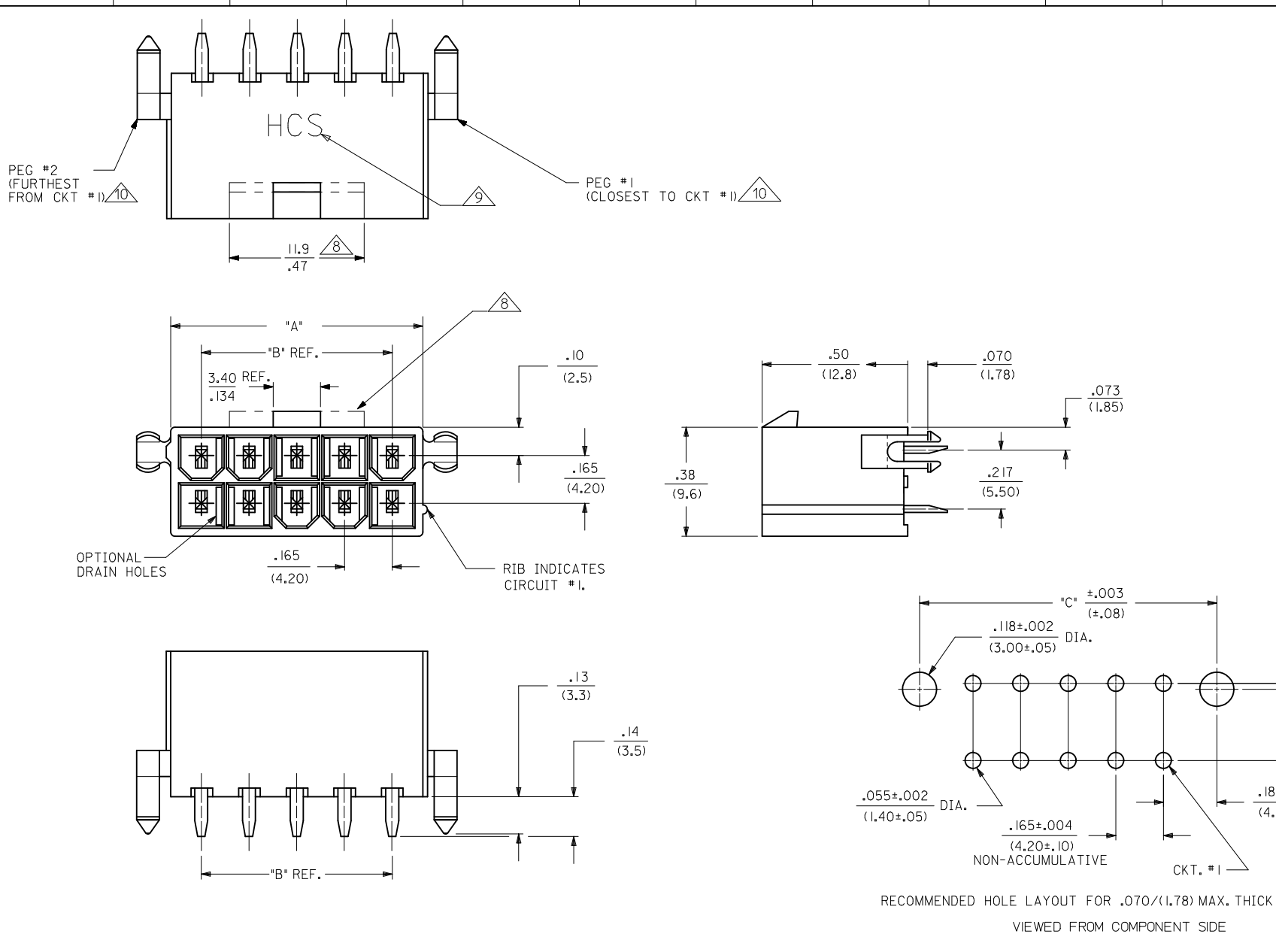

CIRCUIT SIZE	DIM. "A"	DIM. "B"	DIM. "C"
2	.21 (5.4)	—	.370 (9.40)
4	.38 (9.6)	.17 (4.2)	.535 (13.60)
6	.54 (13.8)	.33 (8.4)	.701 (17.80)
8	.71 (18.0)	.50 (12.6)	.866 (22.00)
10	.87 (22.2)	.66 (16.8)	1.031 (26.20)
12	1.04 (26.4)	.83 (21.0)	1.197 (30.40)
14	1.20 (30.6)	.99 (25.2)	1.362 (34.60)
16	1.37 (34.8)	1.16 (29.4)	1.528 (38.80)
18	1.54 (39.0)	1.32 (33.6)	1.693 (43.00)
20	1.70 (43.2)	1.49 (37.8)	1.858 (47.20)
22	1.87 (47.4)	1.65 (42.0)	2.024 (51.40)
24	2.03 (51.6)	1.82 (46.2)	2.189 (55.60)

SEE SHT. I FOR SINGLE ROW

SEE SHEET 1 EC NO: UCP2012-1560 DRAWING: NGUYEN 2012/01/05 CHKD: J. BELL 2012/01/05 APPR: F. SMITH 2012/02/02	QUALITY SYMBOLS ∇=0 ∇=0 ∇=0	GENERAL TOLERANCES (UNLESS SPECIFIED) mm INCH 4 PLACES ± --- ± --- 3 PLACES ± --- ± .015 2 PLACES ± 0.38 ± .020 1 PLACE ± 0.50 ± --- ANGULAR ± 1/2°	DIMENSION STYLE IN/MM DRAWN BY DATE GEP 1994/07/25 CHECKED BY DATE RJF 1994/07/25 APPROVED BY DATE RJF 1994/07/25	SCALE 4:1 DESIGN UNITS METRIC THIRD ANGLE PROJECTION	TITLE MINI-FIT VERT HDR ASSY W & W/O PEGS/DRAIN HOLES SINGLE AND DUAL ROW MOLEX INCORPORATED
	DRAFT WHERE APPLICABLE MUST REMAIN WITHIN DIMENSIONS		MATERIAL NO. SEE CHARTS	DOCUMENT NO. SDA-44472-****	SHEET NO. 2 OF 8
	THIS DRAWING CONTAINS INFORMATION THAT IS PROPRIETARY TO MOLEX INCORPORATED AND SHOULD NOT BE USED WITHOUT WRITTEN PERMISSION				
	SIZE C				

DUAL ROW PART NUMBERS WITH MATTE TIN PLATING

WITH PEGS

PLATING:	I (SEE NOTE 2)	PLATING:	I (SEE NOTE 2)	PLATING:	I (SEE NOTE 2)	PLATING:	I (SEE NOTE 2)
DRAINS:	WITHOUT DRAIN HOLES	DRAINS:	WITHOUT DRAIN HOLES	DRAINS:	WITH DRAIN HOLES	DRAINS:	WITH DRAIN HOLES
PEGS:	WITH PEGS	PEGS:	WITH PEGS	PEGS:	WITH PEGS	PEGS:	WITH PEGS
MAT'L:	94V-2 [NATURAL]	MAT'L:	94V-0 [NATURAL]	MAT'L:	94V-2 [NATURAL]	MAT'L:	94V-0 [NATURAL]
PACKAGING:	PK-5566-001	PACKAGING:	PK-5566-001	PACKAGING:	PK-5566-001	PACKAGING:	PK-5566-001

ITEM NO.	CKTS	ITEM NO.	CKTS	ITEM NO.	CKTS	ITEM NO.	CKTS
44472-0250	2	44472-0251	2	44472-0252	2	44472-0253	2
44472-0450	4	44472-0451	4	44472-0452	4	44472-0453	4
44472-0650	6	44472-0651	6	44472-0652	6	44472-0653	6
44472-0850	8	44472-0851	8	44472-0852	8	44472-0853	8
44472-1050	10	44472-1051	10	44472-1052	10	44472-1053	10
44472-1250	12	44472-1251	12	44472-1252	12	44472-1253	12
44472-1450	14	44472-1451	14	44472-1452	14	44472-1453	14
44472-1650	16	44472-1651	16	44472-1652	16	44472-1653	16
44472-1850	18	44472-1851	18	44472-1852	18	44472-1853	18
44472-2050	20	44472-2051	20	44472-2052	20	44472-2053	20
44472-2250	22	44472-2251	22	44472-2252	22	44472-2253	22
44472-2450	24	44472-2451	24	44472-2452	24	44472-2453	24

WITHOUT PEGS

PLATING:	I (SEE NOTE 2)	PLATING:	I (SEE NOTE 2)	PLATING:	I (SEE NOTE 2)	PLATING:	I (SEE NOTE 2)
DRAINS:	WITHOUT DRAIN HOLES	DRAINS:	WITHOUT DRAIN HOLES	DRAINS:	WITH DRAIN HOLES	DRAINS:	WITH DRAIN HOLES
PEGS:	WITHOUT PEGS	PEGS:	WITHOUT PEGS	PEGS:	WITHOUT PEGS	PEGS:	WITHOUT PEGS
MAT'L:	94V-2 [NATURAL]	MAT'L:	94V-0 [NATURAL]	MAT'L:	94V-2 [NATURAL]	MAT'L:	94V-0 [NATURAL]
PACKAGING:	PK-5566-001	PACKAGING:	PK-5566-001	PACKAGING:	PK-5566-001	PACKAGING:	PK-5566-001

ITEM NO.	HOUSING NO.	CKTS	ITEM NO.	CKTS	ITEM NO.	CKTS	ITEM NO.	CKTS
44472-0254		2	44472-0255	2	44472-0256	2	44472-0257	
44472-0454		4	44472-0455	4	44472-0456	4	44472-0457	
44472-0654		6	44472-0655	6	44472-0656	6	44472-0657	
44472-0854		8	44472-0855	8	44472-0856	8	44472-0857	
44472-1054		10	44472-1055	10	44472-1056	10	44472-1057	
44472-1254		12	44472-1255	12	44472-1256	12	44472-1257	
44472-1454		14	44472-1455	14	44472-1456	14	44472-1457	
44472-1654		16	44472-1655	16	44472-1656	16	44472-1657	
44472-1854		18	44472-1855	18	44472-1856	18	44472-1857	
44472-2054		20	44472-2055	20	44472-2056	20	44472-2057	
44472-2254		22	44472-2255	22	44472-2256	22	44472-2257	
44472-2454		24	44472-2455	24	44472-2456	24	44472-2457	

* ITEMS PRECEDED BY AN *X* ARE NOT AVAILABLE.

SEE SHEET 1 EC NO: UCP2012-1560 DRAWN: NGUYEN 2012/01/05 CHKD: BELL 2012/01/05 APPR: FSM/TH 2012/02/02 M	QUALITY SYMBOLS ∇=0 ∇=0 ∇=0	GENERAL TOLERANCES (UNLESS SPECIFIED)		DIMENSION STYLE IN/MM		SCALE 1:1	DESIGN UNITS METRIC	THIRD ANGLE PROJECTION
				mm	INCH	DRAWN BY GEP	DATE 1994/07/25	
				4 PLACES ± --- ± ---	3 PLACES ± --- ±.015	CHECKED BY RJF	DATE 1994/07/25	MOLEX INCORPORATED
				2 PLACES ± 0.38 ±.020	1 PLACE ± 0.50 ± ---	APPROVED BY RJF	DATE 1994/07/25	
		ANGULAR ±1/2°		DRAFT WHERE APPLICABLE MUST REMAIN WITHIN DIMENSIONS		THIS DRAWING CONTAINS INFORMATION THAT IS PROPRIETARY TO MOLEX INCORPORATED AND SHOULD NOT BE USED WITHOUT WRITTEN PERMISSION		

DUAL ROW PART NUMBERS WITH SELECT GOLD PLATING

WITH PEGS

PLATING:		2 (SEE NOTE 2)		PLATING:		2 (SEE NOTE 2)		PLATING:		2 (SEE NOTE 2)	
DRAINS:		WITHOUT DRAIN HOLES		DRAINS:		WITHOUT DRAIN HOLES		DRAINS:		WITH DRAIN HOLES	
PEGS:		WITH PEGS		PEGS:		WITH PEGS		PEGS:		WITH PEGS	
MAT'L:		94V-2 [NATURAL]		MAT'L:		94V-0 [NATURAL]		MAT'L:		94V-0 [NATURAL]	
PACKAGING:		PK-5566-001		PACKAGING:		PK-5566-001		PACKAGING:		PK-5566-001	
	ITEM NO.		CKTS		ITEM NO.		CKTS		ITEM NO.		CKTS
X	44472-0260		2	X	44472-0261		2	X	44472-0262		2
X	44472-0460		4	X	44472-0461		4	X	44472-0462		4
X	44472-0660		6	X	44472-0661		6	X	44472-0662		6
X	44472-0860		8	X	44472-0861		8	X	44472-0862		8
X	44472-1060		10	X	44472-1061		10	X	44472-1062		10
X	44472-1260		12	X	44472-1261		12	X	44472-1262		12
X	44472-1460		14	X	44472-1461		14	X	44472-1462		14
X	44472-1660		16	X	44472-1661		16	X	44472-1662		16
X	44472-1860		18	X	44472-1861		18	X	44472-1862		18
X	44472-2060		20	X	44472-2061		20	X	44472-2062		20
X	44472-2260		22	X	44472-2261		22	X	44472-2262		22
X	44472-2460		24	X	44472-2461		24	X	44472-2462		24

WITHOUT PEGS

PLATING:		2 (SEE NOTE 2)		PLATING:		2 (SEE NOTE 2)		PLATING:		2 (SEE NOTE 2)	
DRAINS:		WITHOUT DRAIN HOLES		DRAINS:		WITHOUT DRAIN HOLES		DRAINS:		WITH DRAIN HOLES	
PEGS:		WITHOUT PEGS		PEGS:		WITHOUT PEGS		PEGS:		WITHOUT PEGS	
MAT'L:		94V-2 [NATURAL]		MAT'L:		94V-0 [NATURAL]		MAT'L:		94V-0 [NATURAL]	
PACKAGING:		PK-5566-001		PACKAGING:		PK-5566-001		PACKAGING:		PK-5566-001	
	ITEM NO.		CKTS		ITEM NO.		CKTS		ITEM NO.		CKTS
X	44472-0264		2	X	44472-0265		2	X	44472-0267		2
X	44472-0464		4	X	44472-0465		4	X	44472-0467		4
X	44472-0664		6	X	44472-0665		6	X	44472-0667		6
X	44472-0864		8	X	44472-0865		8	X	44472-0867		8
X	44472-1064		10	X	44472-1065		10	X	44472-1067		10
X	44472-1264		12	X	44472-1265		12	X	44472-1267		12
X	44472-1464		14	X	44472-1465		14	X	44472-1467		14
X	44472-1664		16	X	44472-1665		16	X	44472-1667		16
X	44472-1864		18	X	44472-1865		18	X	44472-1867		18
X	44472-2064		20	X	44472-2065		20	X	44472-2067		20
X	44472-2264		22	X	44472-2265		22	X	44472-2267		22
X	44472-2464		24	X	44472-2465		24	X	44472-2467		24

* ITEMS PRECEDED BY A "X" ARE NOT AVAILABLE.

SEE SHEET 1 EC NO: UCP2012-1560 DRAWN: NGUYEN 2012/01/05 CHKD: BELLS 2012/01/05 APPR: FSM/TH 2012/02/02 REV: M	QUALITY SYMBOLS	GENERAL TOLERANCES (UNLESS SPECIFIED)	DIMENSION STYLE IN/MM	SCALE 1:1	DESIGN UNITS METRIC	THIRD ANGLE PROJECTION
	▽=0	4 PLACES ± --- ± ---	DRAWN BY GEP DATE 1994/07/25	TITLE MINI-FIT VERT HDR ASSY W & W/O PEGS/DRAIN HOLES SINGLE AND DUAL ROW		
	▽=0	3 PLACES ± --- ±.015	CHECKED BY RJF DATE 1994/07/25	MOLEX INCORPORATED		
	▽=0	2 PLACES ± 0.38 ±.020	APPROVED BY RJF DATE 1994/07/25	DOCUMENT NO. SDA-44472-****		
		1 PLACE ± 0.50 ± ---	MATERIAL NO. SEE CHARTS	SHEET NO. 4 OF 8		
		ANGULAR ±1/2°	DRAFT WHERE APPLICABLE MUST REMAIN WITHIN DIMENSIONS			
			THIS DRAWING CONTAINS INFORMATION THAT IS PROPRIETARY TO MOLEX INCORPORATED AND SHOULD NOT BE USED WITHOUT WRITTEN PERMISSION			

DUAL ROW PART NUMBERS WITH WIDE LATCH OPTION

WITH PEGS

PLATING:	1 (SEE NOTE 2)
DRAINS:	WITH DRAIN HOLES
PEGS:	WITH PEGS
MAT'L:	94V-2 [NATURAL]
PACKAGING:	PK-5566-001

	ITEM NO.	CKTS
X	44472-0270	2
X	44472-0470	4
X	44472-0670	6
X	44472-0870	8
X	44472-1070	10
X	44472-1270	12
X	44472-1470	14
X	44472-1670	16
X	44472-1870	18
X	44472-2070	20
X	44472-2270	22
	44472-2470	24

* ITEMS PRECEDED BY *X* ARE NOT AVAILABLE.

SEE SHEET 1 EC NO: UCP2012-1560 DRW: NGUYEN 2012/01/05 CHKD: BELL 2012/01/05 APPR: FSMITH 2012/02/02	QUALITY SYMBOLS 	GENERAL TOLERANCES (UNLESS SPECIFIED)		DIMENSION STYLE IN/MM		SCALE 1:1	DESIGN UNITS METRIC	THIRD ANGLE PROJECTION
			mm	INCH	DRAWN BY GEP	DATE 1994/07/25	TITLE	
			4 PLACES ± ---	± ---	CHECKED BY RJF	DATE 1994/07/25	MINI-FIT VERT HDR ASSY W & W/O PEGS/DRAIN HOLES SINGLE AND DUAL ROW	
			3 PLACES ± ---	± .015	APPROVED BY RJF	DATE 1994/07/25		
	2 PLACES ± 0.38	± .020	MATERIAL NO. SEE CHART		MOLEX INCORPORATED			
	1 PLACE ± 0.50	± ---	DOCUMENT NO. SDA-44472-****					
	ANGULAR ± 1/2°		SHEET NO. 5 OF 8					
DRAFT WHERE APPLICABLE MUST REMAIN WITHIN DIMENSIONS		SIZE C		THIS DRAWING CONTAINS INFORMATION THAT IS PROPRIETARY TO MOLEX INCORPORATED AND SHOULD NOT BE USED WITHOUT WRITTEN PERMISSION				

SINGLE ROW PART NUMBERS WITH PEGS

MATTE TIN PLATING

PLATING:	1 (SEE NOTE 2)	PLATING:	1 (SEE NOTE 2)	PLATING:	1 (SEE NOTE 2)	PLATING:	1 (SEE NOTE 2)
DRAINS:	WITH DRAIN HOLES	DRAINS:	WITH DRAIN HOLES	DRAINS:	WITHOUT DRAIN HOLES	DRAINS:	WITHOUT DRAIN HOLES
PEGS:	WITH PEGS	PEGS:	WITH PEGS	PEGS:	WITH PEGS	PEGS:	WITH PEGS
MAT'L:	94V-2 [NATURAL]	MAT'L:	94V-0 [NATURAL]	MAT'L:	94V-2 [NATURAL]	MAT'L:	94V-0 [NATURAL]
PACKAGING:	PK-5566-002	PACKAGING:	PK-5566-002	PACKAGING:	PK-5566-002	PACKAGING:	PK-5566-002
ITEM NO.		CKTS		ITEM NO.		CKTS	
	44472-0401	4	X	44472-0402		4	X
X	44472-0501	5		44472-0502		5	X
X	44472-0601	6	X	44472-0602		6	X
X	44472-0701	7	X	44472-0702		7	X
X	44472-0801	8	X	44472-0802		8	X
X	44472-0901	9	X	44472-0902		9	X
X	44472-1001	10	X	44472-1002		10	X
X	44472-1101	11	X	44472-1102		11	X
X	44472-1201	12	X	44472-1202		12	X

GOLD PLATING

PLATING:		PLATING:		PLATING:	2 (SEE NOTE 2)	PLATING:	2 (SEE NOTE 2)
DRAINS:		DRAINS:		DRAINS:	WITHOUT DRAIN HOLE	DRAINS:	WITHOUT DRAIN HOLES
PEGS:		PEGS:		PEGS:	WITH PEGS	PEGS:	WITH PEGS
MAT'L:		MAT'L:		MAT'L:	94V-2 [NATURAL]	MAT'L:	94V-0 [NATURAL]
PACKAGING:		PACKAGING:		PACKAGING:	PK-5566-002	PACKAGING:	PK-5566-002
ITEM NO.		CKTS		ITEM NO.		CKTS	
		4		44472-0407		4	X
		5		44472-0507		5	X
		6		44472-0607		6	X
		7		44472-0707		7	X
		8		44472-0807		8	X
		9		44472-0907		9	X
		10		44472-1007		10	X
		11		44472-1107		11	X
		12		44472-1207		12	X

SEE SHEET 1 EC NO: UCP2012-1560 DRAWN: NGUYEN 2012/01/05 CHKD: BELM 2012/01/05 APPR: FSMITH 2012/02/02 M	QUALITY SYMBOLS ▽ = 0 ▽ = 0 ▽ = 0	GENERAL TOLERANCES (UNLESS SPECIFIED)	DIMENSION STYLE IN/MM	SCALE 1:1	DESIGN UNITS METRIC	THIRD ANGLE PROJECTION
		4 PLACES ± --- ± --- 3 PLACES ± --- ± .015 2 PLACES ± 0.38 ± .020 1 PLACE ± 0.50 ± ---	mm INCH DRAWN BY DATE GEP 1994/07/25 CHECKED BY DATE RJF 1994/07/25 APPROVED BY DATE RJF 1994/07/25	TITLE MINI-FIT VERT HDR ASSY W & W/O PEGS/DRAIN HOLES SINGLE AND DUAL ROW		
		ANGULAR ±1/2°	MATERIAL NO. SEE CHART	MOLEX INCORPORATED		
		DRAFT WHERE APPLICABLE MUST REMAIN WITHIN DIMENSIONS	DOCUMENT NO. SDA-44472-****	SHEET NO. 6 OF 8		
		SIZE THIS DRAWING CONTAINS INFORMATION THAT IS PROPRIETARY TO MOLEX INCORPORATED AND SHOULD NOT BE USED WITHOUT WRITTEN PERMISSION				

DUAL ROW PART NUMBERS 1 PEG REMOVED

PLATING:	I (SEE NOTE 2)				PLATING:	I (SEE NOTE 2)				PLATING:					PLATING:				
DRAINS:	WITHOUT DRAIN HOLES				DRAINS:	WITH DRAIN HOLES				DRAINS:					DRAINS:				
PEGS:	PEG #1 REMOVED				PEGS:	PEG #1 REMOVED				PEGS:	PEG #1 REMOVED				PEGS:	PEG #1 REMOVED			
MAT'L:	92V-2 (NATURAL)				MAT'L:	92V-2 (NATURAL)				MAT'L:					MAT'L:				
PACKAGING:	PK-5566-001				PACKAGING:	PK-5566-001				PACKAGING:					PACKAGING:				
X	ITEM NO.			CKTS	X	ITEM NO.			CKTS	ITEM NO.			CKTS	ITEM NO.			CKTS		
X	44472-0273			2	X	44472-0274			2				2				2		
X	44472-0473			4	X	44472-0474			4				4				4		
X	44472-0673			6	X	44472-0674			6				6				6		
X	44472-0873			8	X	44472-0874			8				8				8		
X	44472-1073			10	X	44472-1074			10				10				10		
X	44472-1273			12	X	44472-1274			12				12				12		
X	44472-1473			14	X	44472-1474			14				14				14		
X	44472-1673			16	X	44472-1674			16				16				16		
X	44472-1873			18	X	44472-1874			18				18				18		
X	44472-2073			20	X	44472-2074			20				20				20		
X	44472-2273			22	X	44472-2274			22				22				22		
X	44472-2473			24	X	44472-2474			24				24				24		

PLATING:	I (SEE NOTE 2)				PLATING:	I (SEE NOTE 2)				PLATING:					PLATING:				
DRAINS:	WITHOUT DRAIN HOLES				DRAINS:	WITH DRAIN HOLES				DRAINS:					DRAINS:				
PEGS:	PEG #2 REMOVED				PEGS:	PEG #2 REMOVED				PEGS:	PEG #2 REMOVED				PEGS:	PEG #2 REMOVED			
MAT'L:	92V-2 (NATURAL)				MAT'L:	92V-2 (NATURAL)				MAT'L:					MAT'L:				
PACKAGING:	PK-5566-001				PACKAGING:	PK-5566-001				PACKAGING:					PACKAGING:				
X	ITEM NO.			CKTS	X	ITEM NO.			CKTS	ITEM NO.			CKTS	ITEM NO.			CKTS		
X	44472-0277			2	X	44472-0278			2				2				2		
X	44472-0477			4	X	44472-0478			4				4				4		
X	44472-0677			6	X	44472-0678			6				6				6		
X	44472-0877			8	X	44472-0878			8				8				8		
X	44472-1077			10	X	44472-1078			10				10				10		
X	44472-1277			12	X	44472-1278			12				12				12		
X	44472-1477			14	X	44472-1478			14				14				14		
X	44472-1677			16	X	44472-1678			16				16				16		
X	44472-1877			18	X	44472-1878			18				18				18		
X	44472-2077			20	X	44472-2078			20				20				20		
X	44472-2277			22	X	44472-2278			22				22				22		
X	44472-2477			24	X	44472-2478			24				24				24		





* ITEMS PRECEDED BY AN 'X' ARE NOT AVAILABLE

SEE SHEET 1 EC NO: UCP2012-1560 DRAWING: NGUYEN 2012/01/05 CHKD: J.BELL 2012/01/05 APPR: F.S.MITH 2012/02/02	DESCRIPTION REV	QUALITY SYMBOLS	GENERAL TOLERANCES (UNLESS SPECIFIED)	DIMENSION STYLE	SCALE	DESIGN UNITS	THIRD ANGLE PROJECTION
		▽=0	mm INCH	IN/MM	1:1	METRIC	MINI-FIT VERT HDR ASSY W & W/O PEGS/DRAIN HOLES SINGLE AND DUAL ROW MOLEX INCORPORATED
		▽=0	4 PLACES ± --- ± ---	DRAWN BY DATE	GEP 1994/07/25 CHECKED BY DATE RJF 1994/07/25 APPROVED BY DATE RJF 1994/07/25		
		▽=0	3 PLACES ± --- ±.015	2 PLACES ±0.38 ±.020		1 PLACE ±0.50 ±---	
ANGULAR ±1/2°			DRAFT WHERE APPLICABLE MUST REMAIN WITHIN DIMENSIONS		MATERIAL NO. SEE CHART		DOCUMENT NO. SDA-44472-****
			SIZE C		THIS DRAWING CONTAINS INFORMATION THAT IS PROPRIETARY TO MOLEX INCORPORATED AND SHOULD NOT BE USED WITHOUT WRITTEN PERMISSION		

DUAL ROW PART NUMBERS WITH MATTE TIN PLATING
(DO NOT USE FOR NEW APPLICATIONS)

WITH PEGS			
PLATING:	1 (SEE NOTE 2)		
DRAINS:	WITH DRAIN HOLES		
PEGS:	WITH PEGS		
MAT'L:	94V-0 [NATURAL]		
PACKAGING:			
	ITEM NO.		CKTS
	44472-0283	0	2
	44472-0483	0	4
	44472-0683	0	6
	44472-0883		8
	44472-1083	0	10
	44472-1283	0	12
	44472-1483	0	14
	44472-1683	0	16
	44472-1883	0	18
	44472-2083		20
	44472-2283		22
	44472-2483	0	24

0 = OBSOLETE

SEE SHEET 1 EC NO: UCP2012-1560 DRAWN: NGUYEN 2012/01/05 CHKD: BELL 2012/01/05 APPR: F. SMITH 2012/02/02	QUALITY SYMBOLS  = 0  = 0  = 0	GENERAL TOLERANCES (UNLESS SPECIFIED)		DIMENSION STYLE IN/MM		SCALE 1:1	DESIGN UNITS METRIC	 THIRD ANGLE PROJECTION		
		4 PLACES ± --- ± --- 3 PLACES ± --- ± .015 2 PLACES ± 0.38 ± .020 1 PLACE ± 0.50 ± ---	mm INCH ± --- ± --- ± .015 ± .020 ± ---	DRAWN BY GEP	DATE 1994/07/25	TITLE MINI-FIT VERT HDR ASSY W & W/O PEGS/DRAIN HOLES SINGLE AND DUAL ROW				
		ANGULAR ± 1/2°		CHECKED BY RJF	DATE 1994/07/25	APPROVED BY RJF		DATE 1994/07/25	 MOLEX INCORPORATED	
		DRAFT WHERE APPLICABLE MUST REMAIN WITHIN DIMENSIONS		MATERIAL NO. SEE CHART		DOCUMENT NO. SDA-44472-****		SHEET NO. 8 OF 8		
M	REV	THIS DRAWING CONTAINS INFORMATION THAT IS PROPRIETARY TO MOLEX INCORPORATED AND SHOULD NOT BE USED WITHOUT WRITTEN PERMISSION								