

# 1-Watt SMD 6mm (120° Viewing Angle)

## OVSPxBCR4 Series

- Robust energy-efficient design with long operating life
- Low thermal resistance
- Exceptional spatial uniformity
- Optional optics to suit application
- Available in yellow, blue, green, red and white

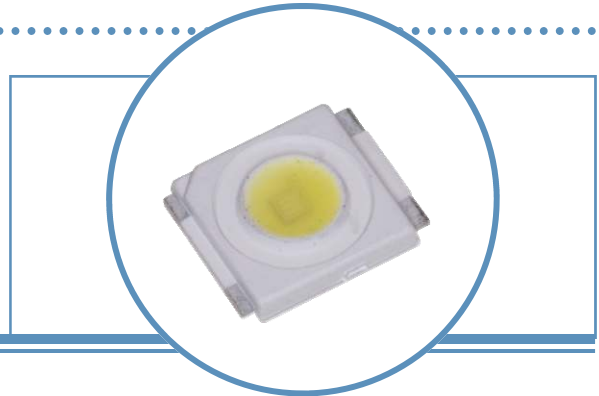

The **OVSPxBCR4 Series** is an energy-efficient packaged LED source that offers high luminance, and a long operating lifespan. These devices offer a 120° viewing angle and an ultra-low profile (1.5mm) making them highly suitable for conventional lighting and specialized applications. Optional optics are offered to suit application. Please contact OPTEK for more information.

## Applications

- Automotive exterior and interior lighting
- Architectural indoor and outdoor lighting
- General lighting
- Electronic signs and signals

Part Number	Viewing Angle	Emitted Color	Typical Luminous Flux (lm)	Typical On-Axis Intensity (cd)	Lens Color
OVSPBBCR4	120°	Blue	9	3.4	Water Clear
OVSPGBCR4		Green	48	18.2	Water Clear
OVSPRBCR4		Red	26	9	Water Clear
OVSPYBCR4		Yellow	35	11.25	Water Clear
OVSPWBCR4		White	75	na	Water Clear
OVSPWWBCR4		Warm White	50	na	Water Clear

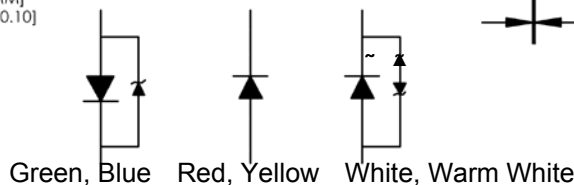
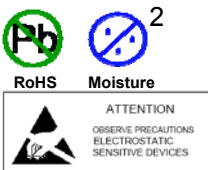
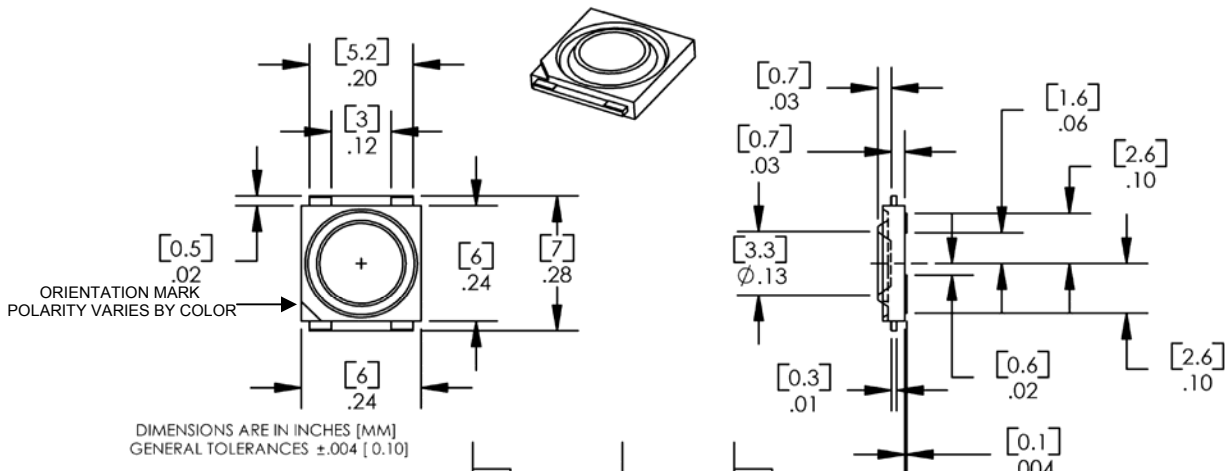

**DO NOT LOOK DIRECTLY AT LED WITH UNSHIELDED EYES OR DAMAGE TO RETINA MAY OCCUR.**

OPTEK reserves the right to make changes at any time in order to improve design and to supply the best product possible.

# 1-Watt SMD 6mm

## OVSPxBCR4 Series



### Absolute Maximum Ratings $T_A = 25^\circ\text{C}$

	Red, Yellow	Green, Blue	White	Warm White
DC Forward Current	400mA	350mA	350mA	350mA
Peak Pulsed Forward Current <sup>1</sup>	500mA	1000mA	1000mA	1000mA
Reverse Voltage	12V	Not designed for reverse bias		
Junction Temperature <sup>2</sup>	125°C	120°C	125°C	120°C
Power Dissipation	1200mW			
Storage and Operating Temperature	-40° ~ +100 ° C			
ESD Threshold (HBM)	2000V			

Notes:

1. Pulse width  $t_p \leq 10\mu\text{s}$ , Duty cycle = 0.1
2. Thermal conductivity = 20K/W for red, yellow, green, blue; and 18K/W for white

### Optical and Electrical Characteristics—Red, Yellow ( $I_F = 400\text{ mA}$ , $T_A = 25^\circ\text{C}$ )

SYMBOL	PARAMETER	MIN	TYP	MAX	UNITS	
$V_F$	Forward Voltage	2.2	2.5	2.8	V	
$\Phi$	Luminous Flux	Red	21	26	33	lm
		Yellow	27	35	42	lm
$\lambda_D$	Dominant Wavelength	Red	620	625	630	nm
		Yellow	585	587	597	nm
$I_R$	Reverse Current	----	100	----	$\mu\text{A}$	
$2\theta_{1/2}$	50% Power Angle	----	120	----	deg	

### Optical and Electrical Characteristics—Blue, Green ( $I_F = 350\text{ mA}$ , $T_A = 25^\circ\text{C}$ )

SYMBOL	PARAMETER	MIN	TYP	MAX	UNITS	
$V_F$	Forward Voltage	----	3.6	4.0	V	
$\Phi$	Luminous Flux	Blue	5.8	9	12	lm
		Green	38	48	60	lm
$\lambda_D$	Dominant Wavelength	Blue	464	470	476	nm
		Green	525	530	535	nm
$2\theta_{1/2}$	50% Power Angle	----	120	----	deg	

### Optical and Electrical Characteristics—White, Warm White ( $I_F = 350\text{ mA}$ , $T_A = 25^\circ\text{C}$ )

SYMBOL	PARAMETER	MIN	TYP	MAX	UNITS	
$V_F$	Forward Voltage	3.0	3.5	4.0	V	
$\Phi$	Luminous Flux	White	52	75	87	lm
		Warm White	39	50	67	lm
$I_R$	Reverse Current	----	10	----	$\mu\text{A}$	
$2\theta_{1/2}$	50% Power Angle	----	120	----	deg	

OPTEK reserves the right to make changes at any time in order to improve design and to supply the best product possible.

### Standard Bins

Lamps are sorted to luminous flux ( $\Phi$ ) and dominant wavelength ( $\lambda_D$ ) bins shown. Orders may be filled with any or all bins contained as below.

#### OVSPRBCR4 (RED) ( $I_F = 400$ mA)

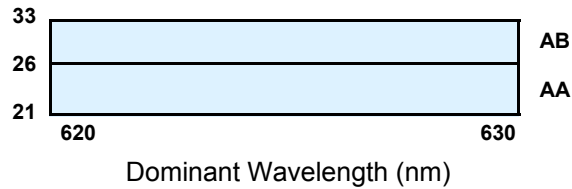

#### OVSPYBCR4 (YELLOW) ( $I_F = 400$ mA)

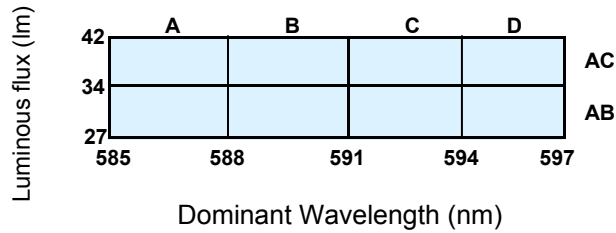

#### OVSPBBCR4 (BLUE) ( $I_F = 350$ mA)

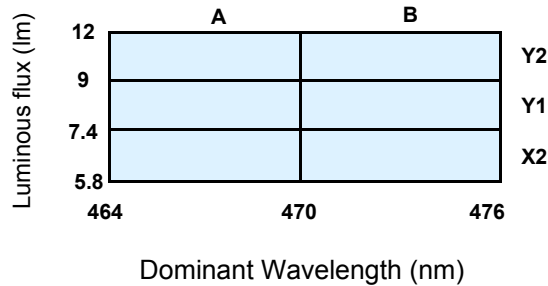

#### OVSPGBCR4 (GREEN) ( $I_F = 350$ mA)

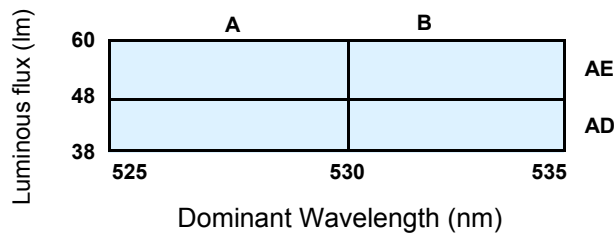

#### Important Notes:

1. All ranks will be included per delivery, rank ratio will be based on the chip distribution.
2. To designate luminous flux ranks, please contact OPTEK.
3. Pb content <1000PPM.

OPTEK reserves the right to make changes at any time in order to improve design and to supply the best product possible.

# 1-Watt SMD 6mm OVSPxBCR4 Series



## Standard Bins ( $I_F = 350 \text{ mA}$ ) **OVSPWBCR4 (White)**

Lamps are sorted to luminous flux ( $\Phi$ ), chromaticity coordinates, and correlated color temperature (CCT) bins shown. Orders may be filled with any or all bins contained as below.

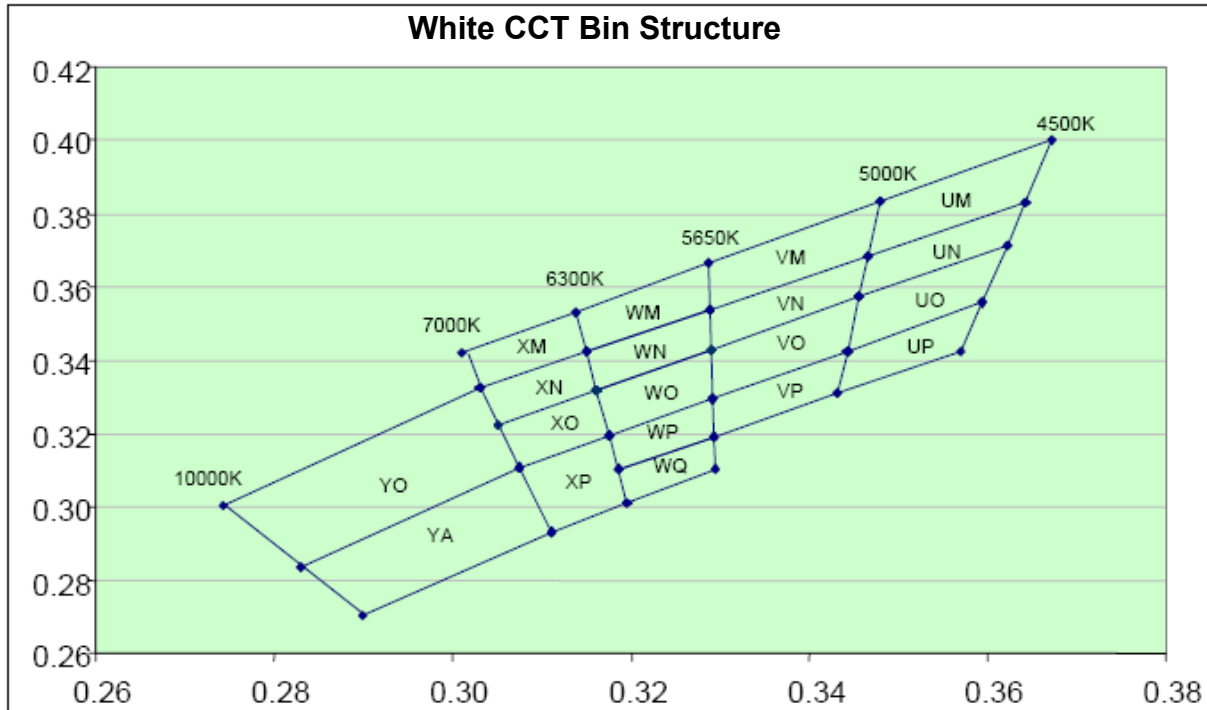

Color Bin	Minimum CCT (K)	Maximum CCT (K)
U	4500	5000
V	5000	5650
W	5650	6300
X	6300	7000
Y	7000	10000

$\Phi$	Luminous Flux (lm)	
Bin	Min	Max
S2	51	59
S3	59	67
T2	67	76
T3	76	87

OPTEK reserves the right to make changes at any time in order to improve design and to supply the best product possible.

Bin		1	2	3	4
YO	Cx	0.274	0.303	0.308	0.283
	Cy	0.301	0.333	0.311	0.284
YA	Cx	0.283	0.308	0.311	0.290
	Cy	0.284	0.311	0.293	0.270
XM	Cx	0.301	0.314	0.315	0.303
	Cy	0.342	0.353	0.343	0.333
XN	Cx	0.303	0.315	0.316	0.305
	Cy	0.333	0.343	0.332	0.322
XO	Cx	0.305	0.316	0.318	0.308
	Cy	0.322	0.332	0.319	0.311
XP	Cx	0.308	0.318	0.320	0.311
	Cy	0.311	0.319	0.301	0.293
WM	Cx	0.314	0.329	0.329	0.315
	Cy	0.353	0.366	0.354	0.343
WN	Cx	0.315	0.329	0.329	0.316
	Cy	0.343	0.354	0.343	0.332
WO	Cx	0.316	0.329	0.329	0.318
	Cy	0.332	0.343	0.330	0.319
WP	Cx	0.318	0.329	0.329	0.319
	Cy	0.319	0.330	0.319	0.310
WQ	Cx	0.319	0.329	0.330	0.320
	Cy	0.310	0.319	0.311	0.301
VM	Cx	0.329	0.348	0.347	0.329
	Cy	0.366	0.383	0.368	0.354
VN	Cx	0.329	0.347	0.346	0.329
	Cy	0.354	0.368	0.357	0.343
VO	Cx	0.329	0.346	0.344	0.329
	Cy	0.343	0.357	0.343	0.330
VP	Cx	0.329	0.344	0.343	0.329
	Cy	0.330	0.343	0.331	0.319
UM	Cx	0.348	0.367	0.364	0.347
	Cy	0.383	0.400	0.383	0.368
UN	Cx	0.347	0.364	0.362	0.346
	Cy	0.368	0.383	0.372	0.357
UO	Cx	0.346	0.362	0.359	0.344
	Cy	0.357	0.372	0.356	0.343
UP	Cx	0.344	0.359	0.357	0.343
	Cy	0.343	0.356	0.343	0.331

OPTEK reserves the right to make changes at any time in order to improve design and to supply the best product possible.

# Color Bin—Natural White

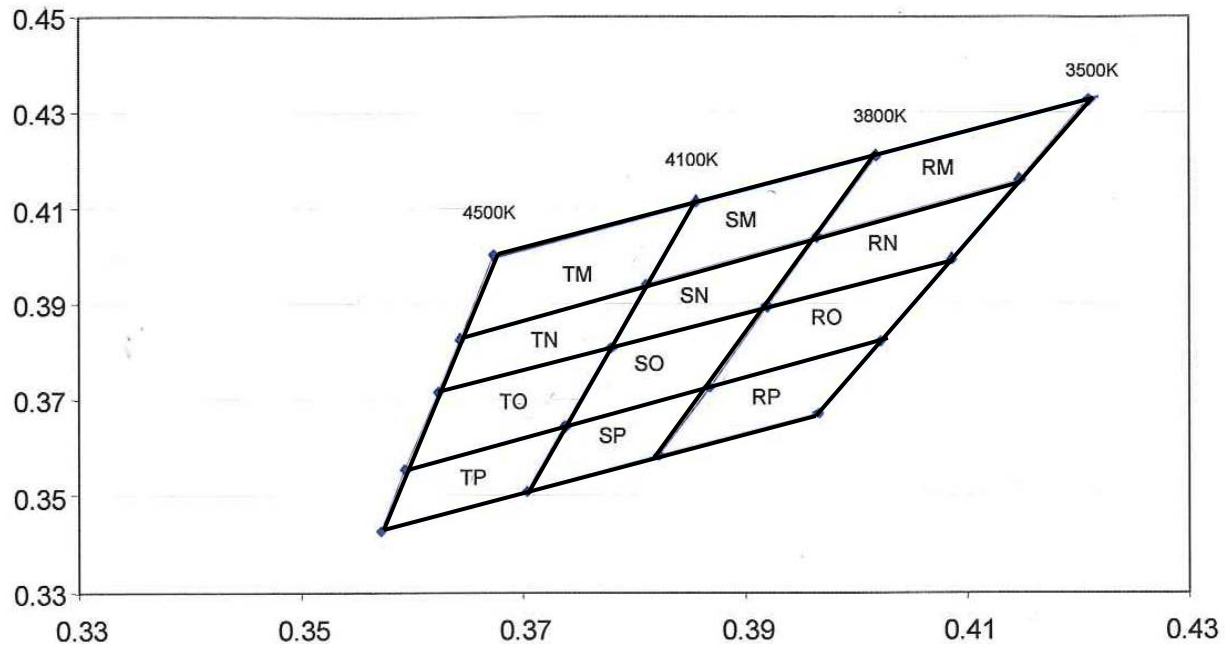

Chromaticity coordinate groups are measured with an accuracy of  $\pm 0.01$

Bin		1	2	3	4
TM	Cx	0.367	0.364	0.381	0.386
	Cy	0.400	0.383	0.394	0.411
TN	Cx	0.364	0.362	0.378	0.381
	Cy	0.383	0.372	0.381	0.394
TO	Cx	0.362	0.359	0.374	0.378
	Cy	0.372	0.356	0.365	0.381
TP	Cx	0.359	0.357	0.370	0.374
	Cy	0.356	0.343	0.351	0.365
SM	Cx	0.386	0.381	0.396	0.402
	Cy	0.411	0.394	0.404	0.421
SN	Cx	0.381	0.378	0.392	0.396
	Cy	0.394	0.381	0.389	0.404
SO	Cx	0.378	0.374	0.387	0.392
	Cy	0.381	0.365	0.373	0.389
SP	Cx	0.374	0.370	0.382	0.387
	Cy	0.365	0.351	0.358	0.373
RM	Cx	0.402	0.396	0.415	0.421
	Cy	0.421	0.404	0.416	0.433
RN	Cx	0.396	0.392	0.409	0.415
	Cy	0.404	0.389	0.399	0.416
RO	Cx	0.392	0.387	0.402	0.409
	Cy	0.389	0.373	0.382	0.399
RP	Cx	0.387	0.382	0.397	0.402
	Cy	0.373	0.358	0.367	0.382

OPTEK reserves the right to make changes at any time in order to improve design and to supply the best product possible.

# 1-Watt SMD 6mm OVSPxBCR4 Series



## Standard Bins ( $I_F = 350 \text{ mA}$ ) **OVSPW~~W~~BCR4 (Warm White)**

Lamps are sorted to luminous flux ( $\Phi$ ), chromaticity coordinates, and correlated color temperature (CCT) bins shown. Orders may be filled with any or all bins contained as below.

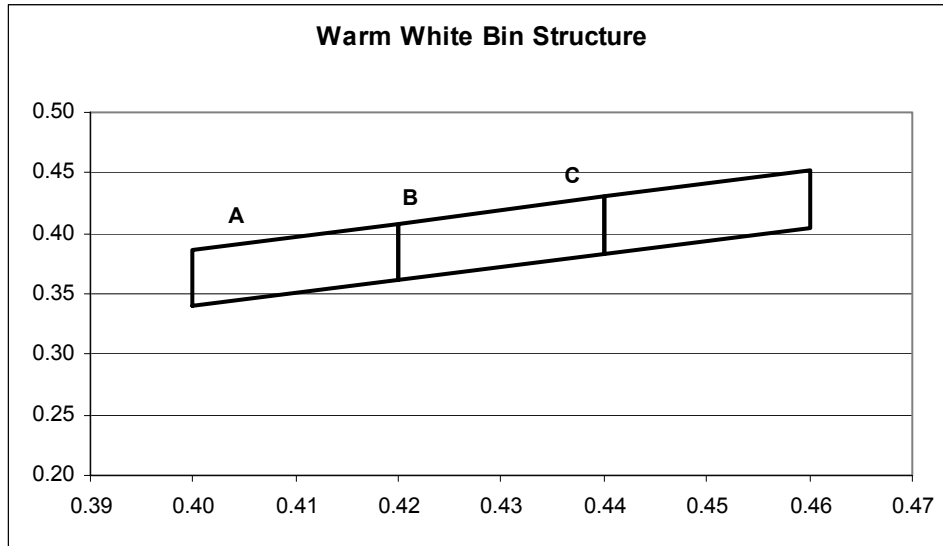

Bin		1	2	3	4
A	$C_x$	0.400	0.420	0.420	0.400
	$C_y$	0.340	0.362	0.408	0.387
B	$C_x$	0.420	0.440	0.440	0.420
	$C_y$	0.362	0.383	0.430	0.408
C	$C_x$	0.440	0.460	0.460	0.440
	$C_y$	0.383	0.405	0.452	0.430

Color Bin	Minimum CCT (K)	Maximum CCT (K)
A	3300	3600
B	3000	3300
C	2800	3000

$\Phi$	Luminous Flux (lm)	
Bin	Min	Max
R2	39	45
R3	45	51
S2	51	59
S3	59	67

OPTEK reserves the right to make changes at any time in order to improve design and to supply the best product possible.

Typical Electro-Optical Characteristics Curves—Red, Yellow

Relative Intensity Vs Forward Current

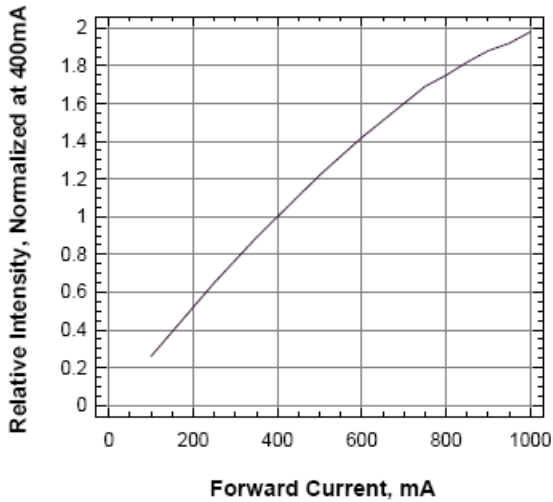

Forward Voltage Vs Forward Current

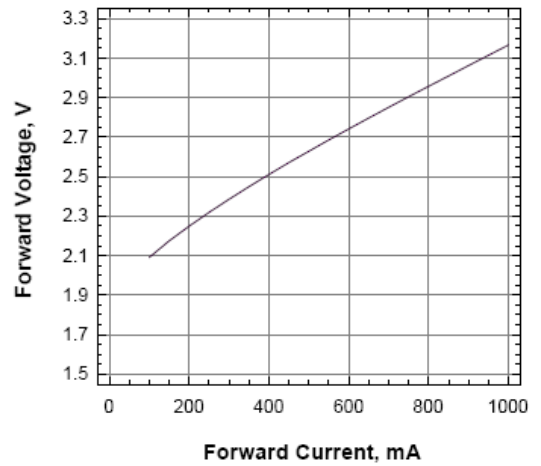

Forward Current Vs Ambient Temperature

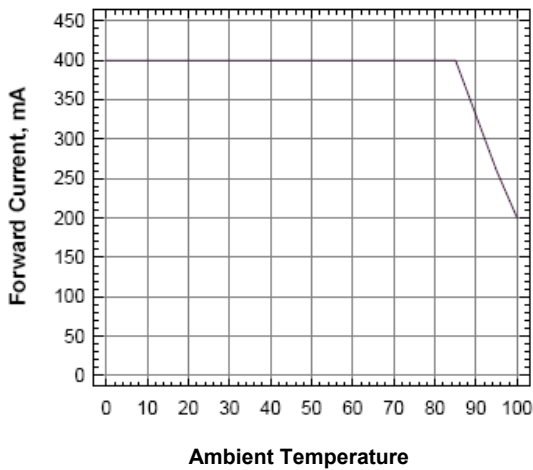

Relative Intensity Vs Wavelength

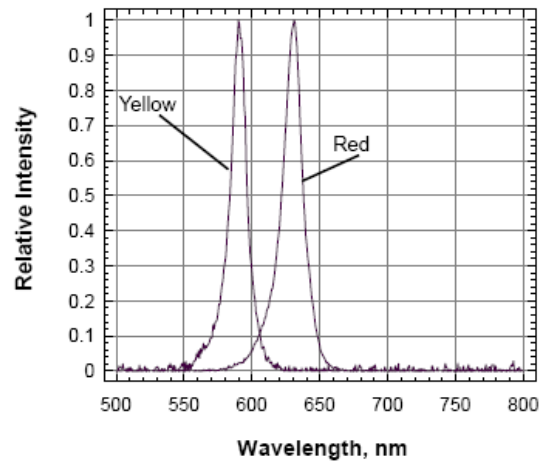

OPTEK reserves the right to make changes at any time in order to improve design and to supply the best product possible.



Typical Electro-Optical Characteristics Curves—Blue, Green

Relative Intensity Vs Forward Current

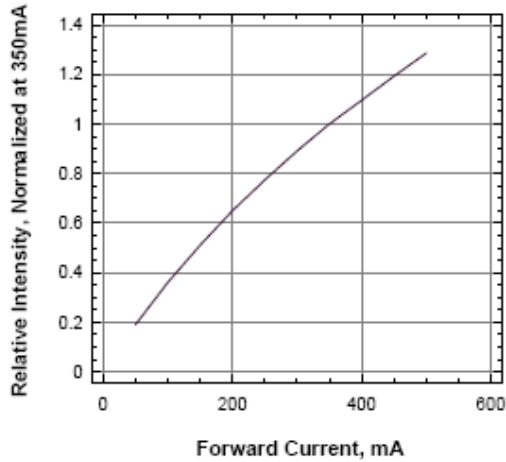

Relative Flux Vs Forward Current

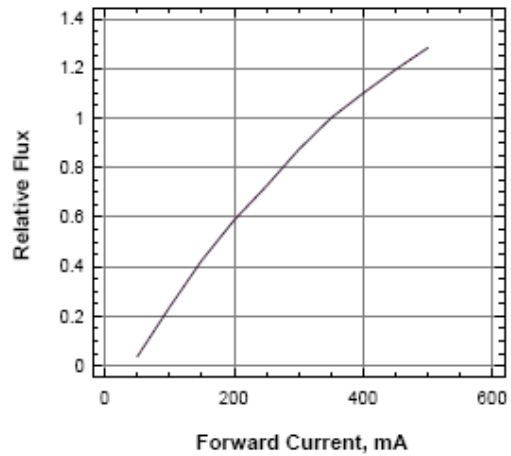

Forward Current Vs Forward Voltage

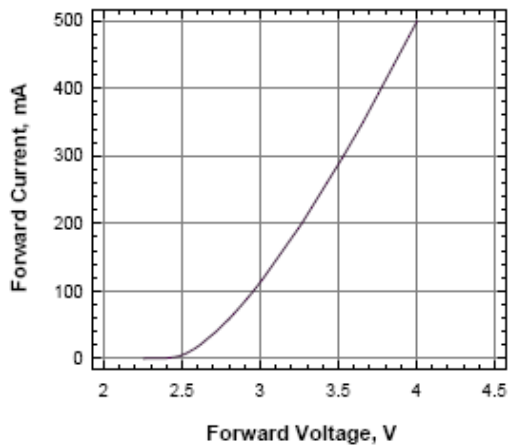

Forward Current Vs Ambient Temperature

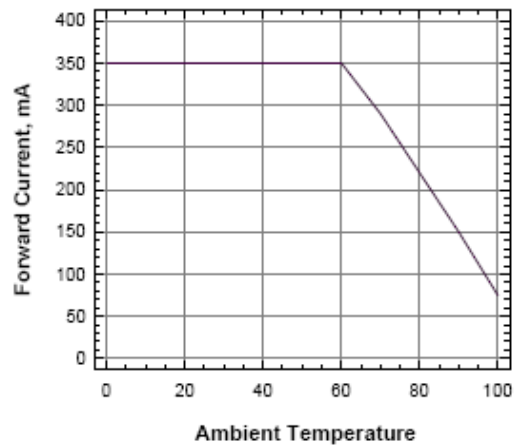

OPTEK reserves the right to make changes at any time in order to improve design and to supply the best product possible.

Typical Electro-Optical Characteristics Curves—White

Relative luminous intensity vs. forward current.

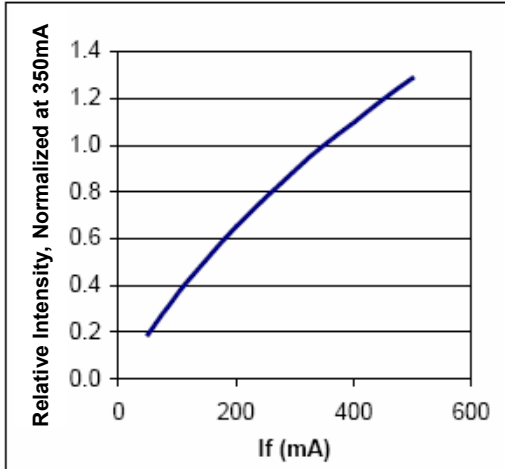

Flux vs. forward current.

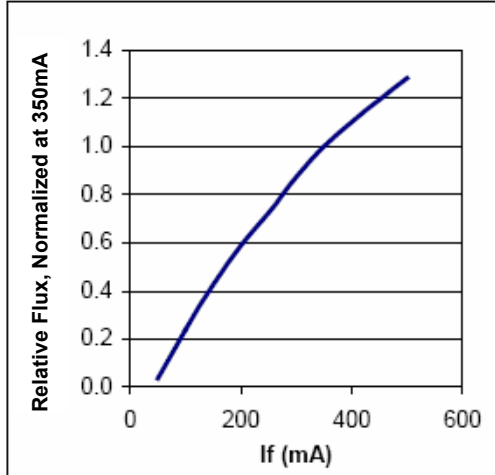

Forward current vs. forward voltage.

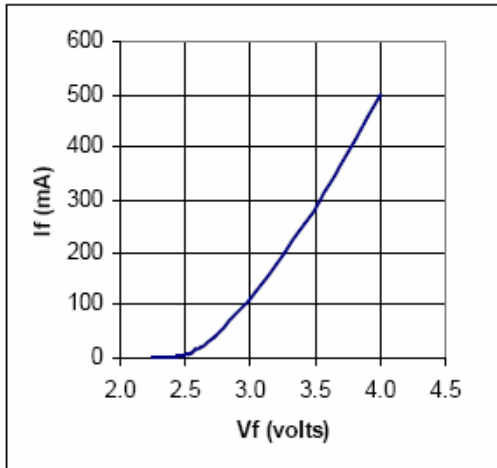

Relative Spectra Emission

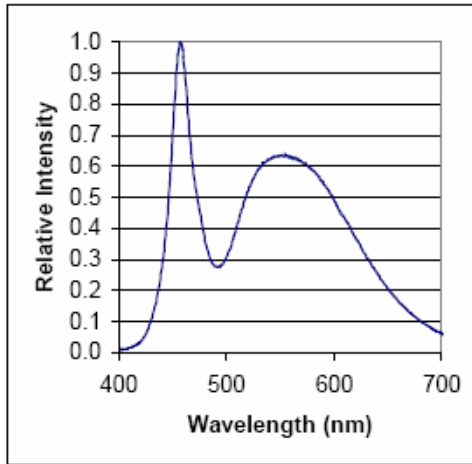

Maximum Permissible Current

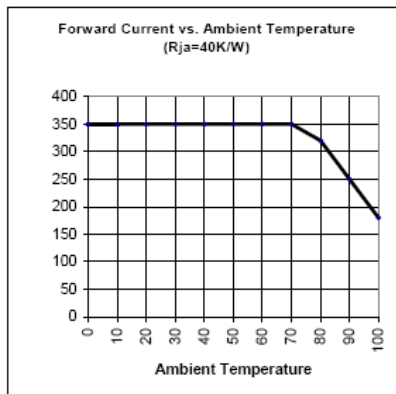

OPTEK reserves the right to make changes at any time in order to improve design and to supply the best product possible.

Typical Electro-Optical Characteristics Curves—Warm White

Relative Intensity Vs Forward Current

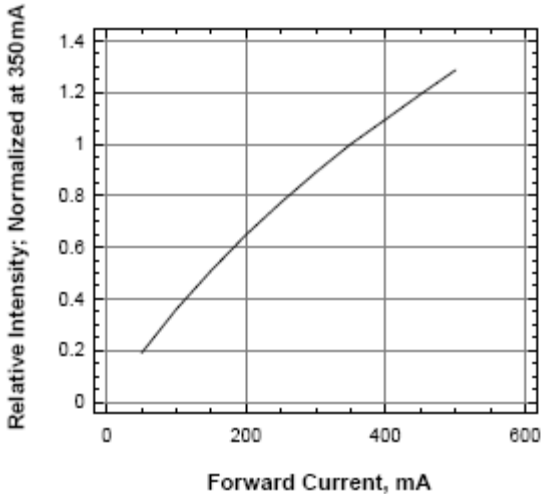

Relative Flux Vs Forward Current

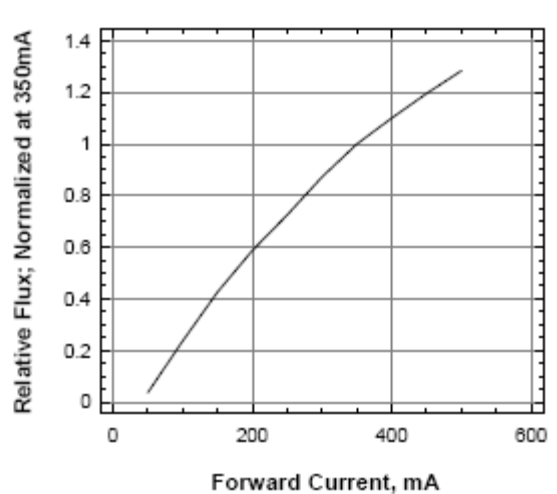

Forward Current Vs Forward Voltage

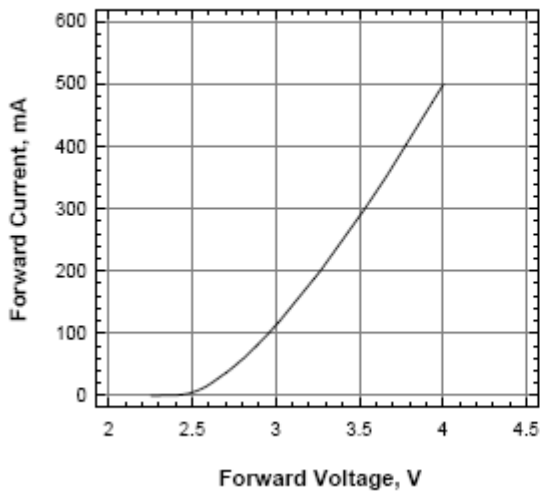

Relative Spectral Emission

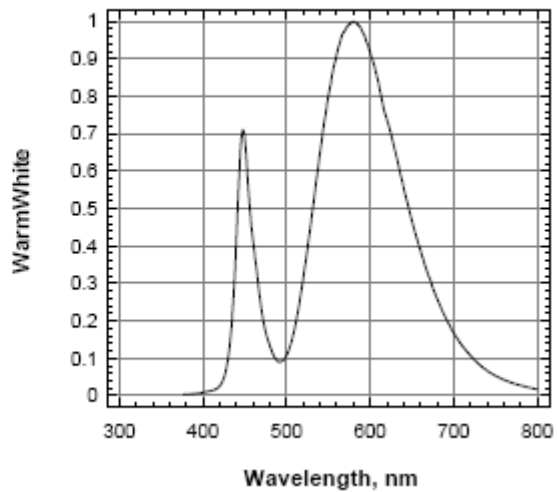

Maximum Permissible Pulse Current, Ta=25

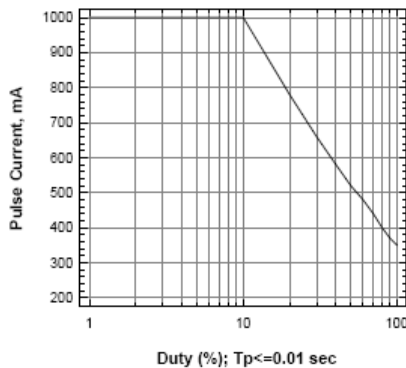

OPTEK reserves the right to make changes at any time in order to improve design and to supply the best product possible.

### Radiation Pattern—All Colors

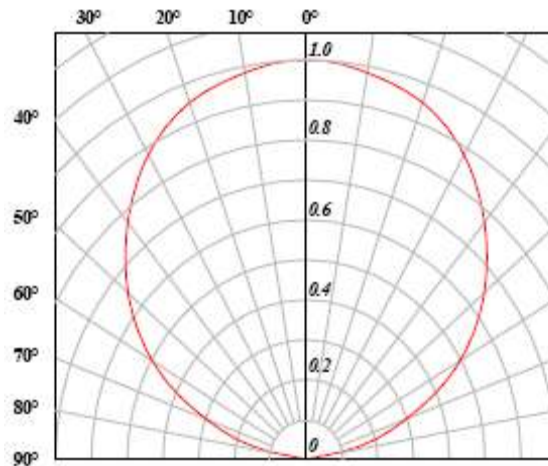

### Solder Pad Design

Note: Metal core circuit board (MCPCB) is highly recommended for high density applications. Please consult sales and marketing for additional information.

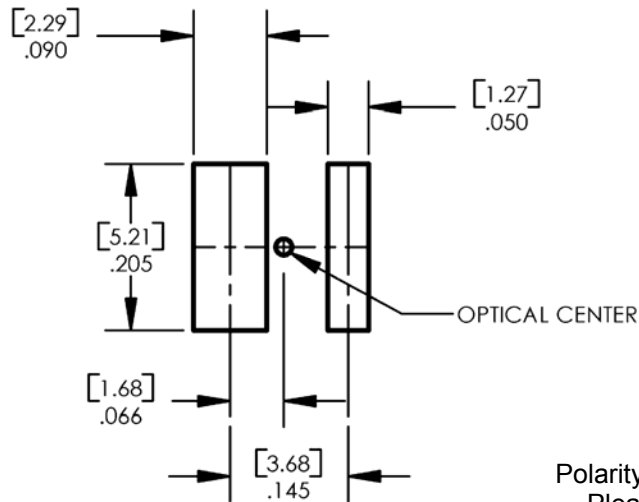

Polarity varies with color.  
Please see Page 1.

OPTEK reserves the right to make changes at any time in order to improve design and to supply the best product possible.

**Recommended Sn-Pb IR-Reflow Soldering Profile.**

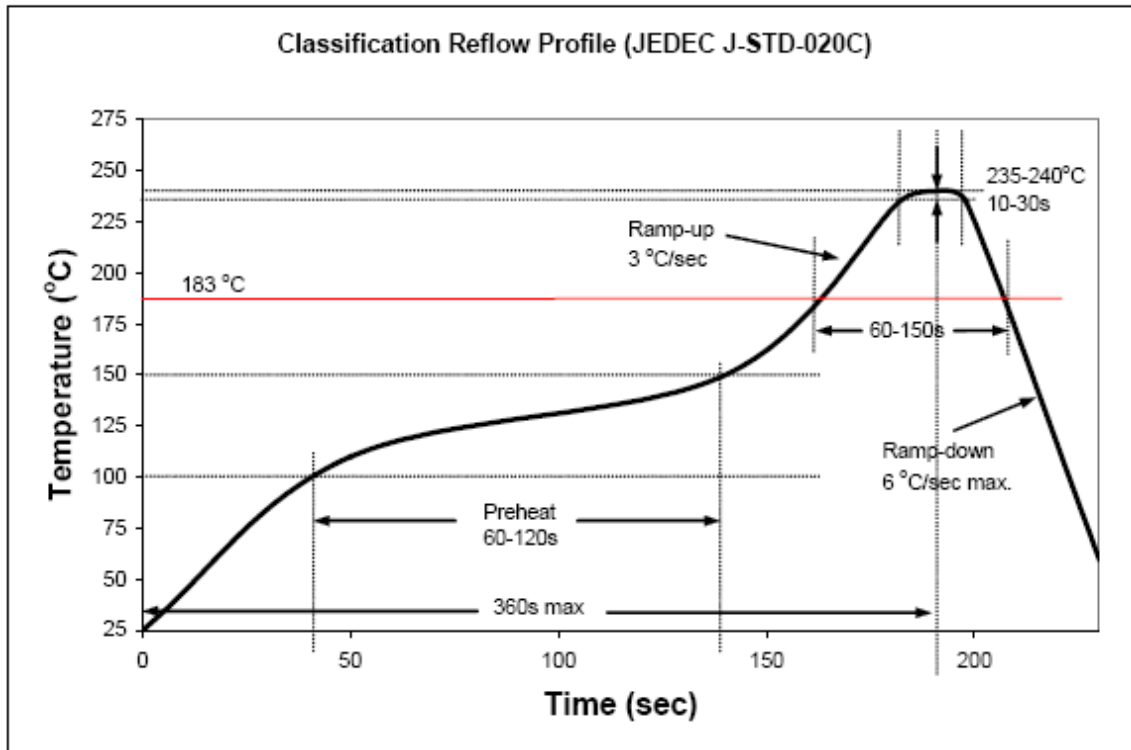

**Recommended Pb Free IR-Reflow Soldering Profile.**

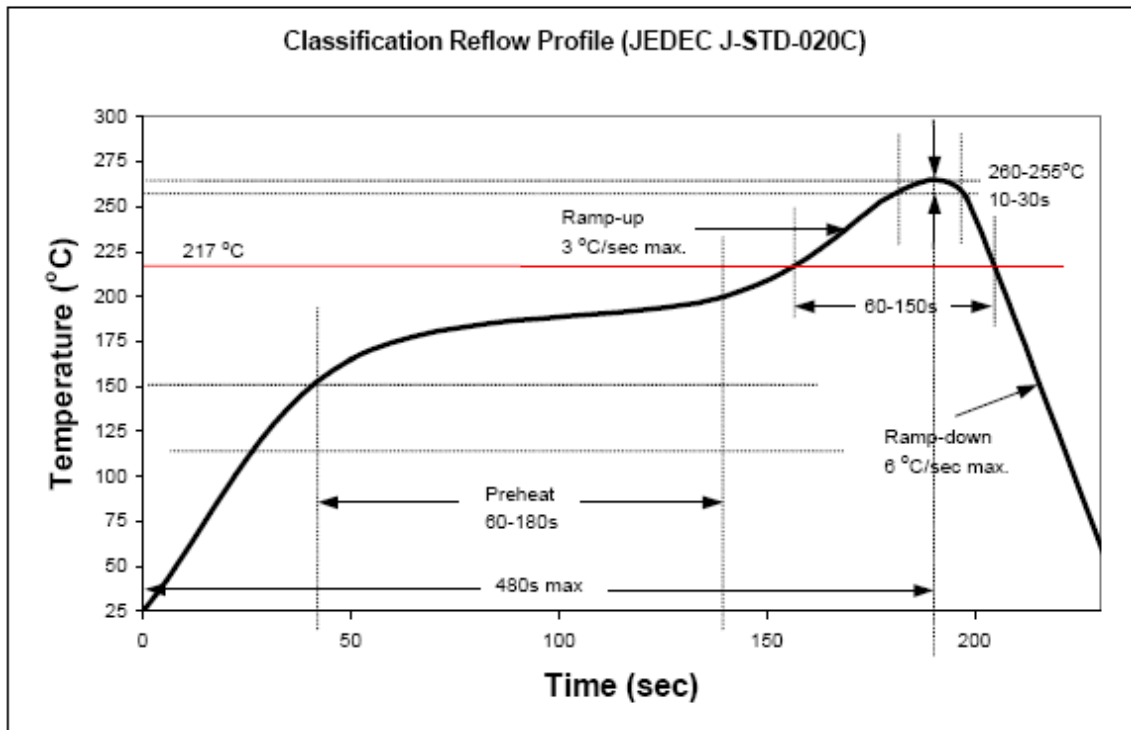

OPTEK reserves the right to make changes at any time in order to improve design and to supply the best product possible.

# 1-Watt SMD 6mm OVSPxBCR4 Series

Taping and Orientation  
Loaded quantity 2000 pieces per reel

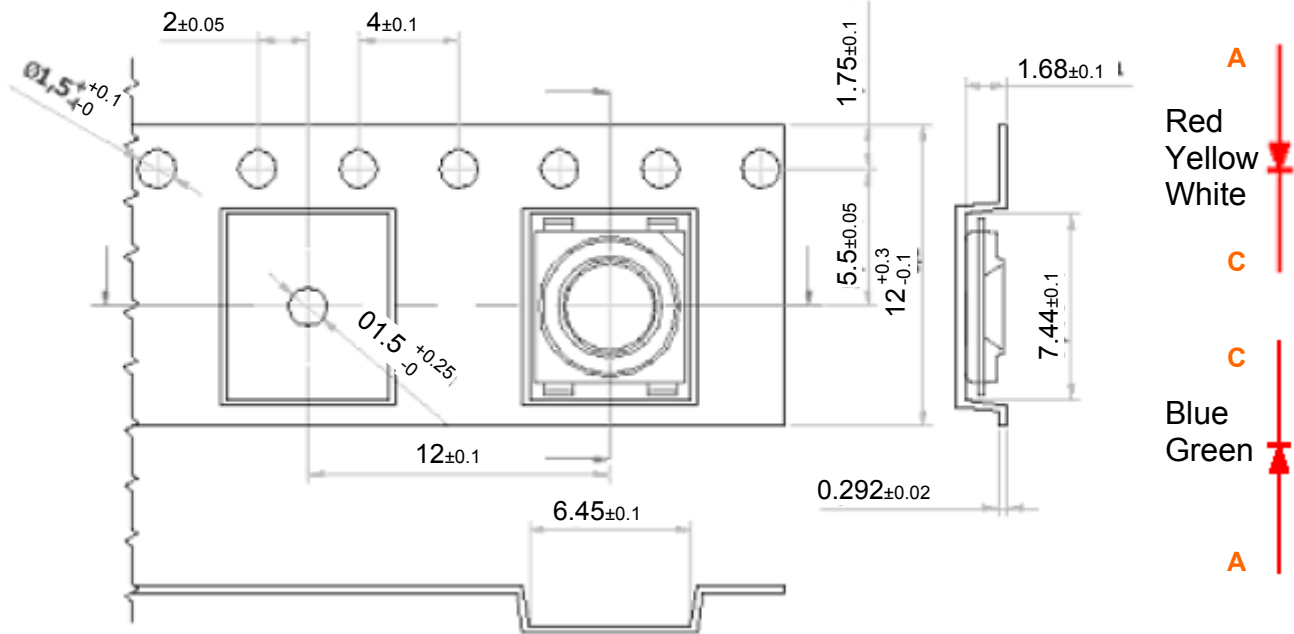

## Reel Dimensions (13 inch)

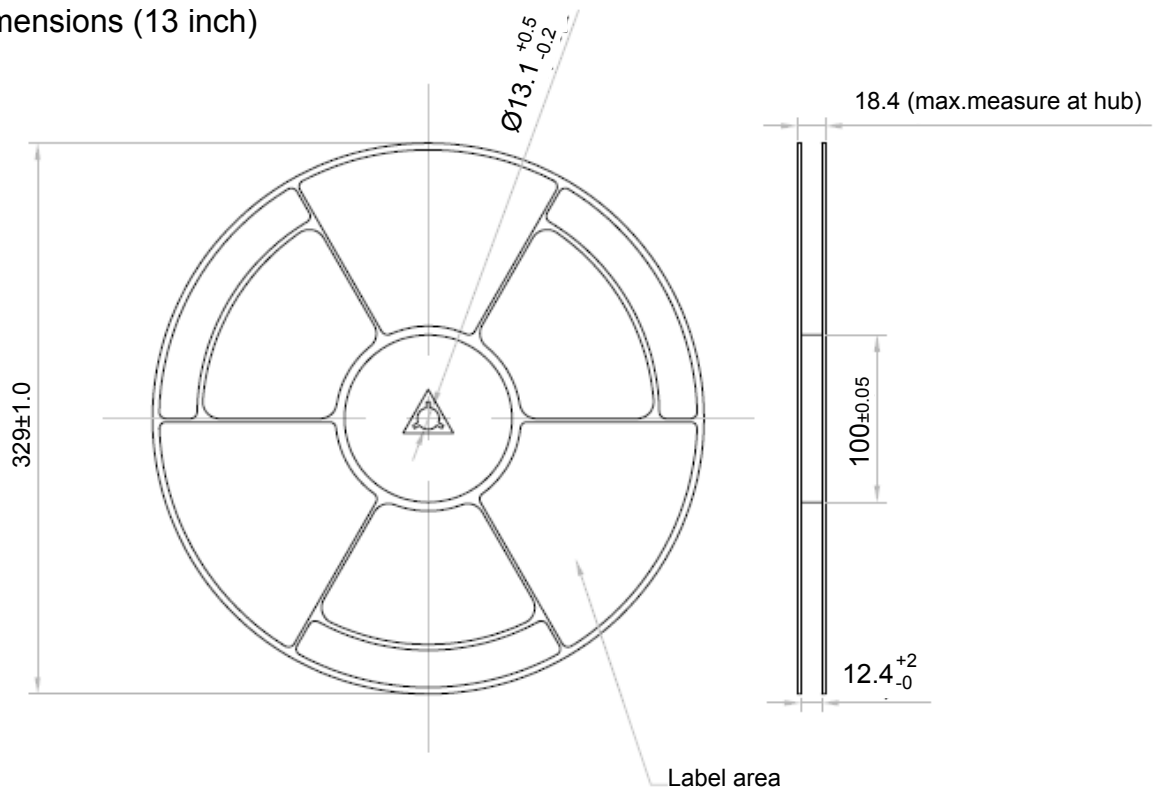

OPTEK reserves the right to make changes at any time in order to improve design and to supply the best product possible.

Moisture Resistant Packaging

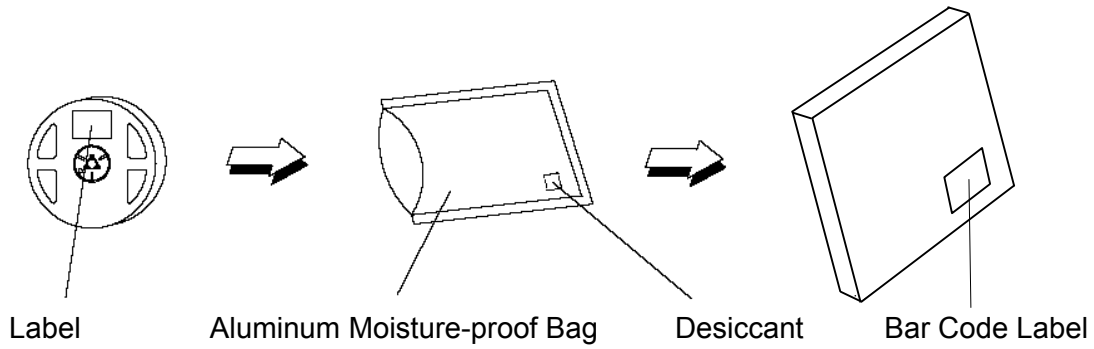

OPTEK reserves the right to make changes at any time in order to improve design and to supply the best product possible.