

SES(F), 320 kA, 120 V UN, 1PH 2W+G DISTRIBUTION SYSTEM

CATALOG NUMBER

SES320F120V



The nVent ERICO SES320 F Series of Surge Protective Devices (SPD) is an enhanced version of our nVent ERICO SES320B Series. The SES320 F Surge-Filter is robust and features a 320 kA per phase surge rating, increasing both survivability and overall life cycle. With the addition of a filter, bothersome high frequency transients on the power distribution system are attenuated, therefore protecting sensitive equipment. The F Series is a cUL 1449 Listed SPD for Type 2 locations. Typical applications for the nVent ERICO SES320 F Series service entrances, distribution, branch panels, MCC, lighting panels, HVAC, A/V systems, IT equipment, and more.

CERTIFICATIONS



FEATURES

Compact design can be directly mounted to panel or installed in a small space

Front-facing design eases installation and performance monitoring

320 kA 8/20 μ s maximum surge rating per phase

Up to 60 dB attenuation (10 kHz to 100 MHz)

Ground reference monitoring triggers an alarm when N-PE mode exceeds 20 volts

Optional Flush Mounting Plate

10-year limited warranty

PRODUCT ATTRIBUTES

Nominal System Voltage (Un): 120 V

Max Continuous Operating Voltage (Uc): 180 V

Distribution System: 1Ph 2W+G

Filtering: -40 dB @ 100 kHz dB

Frequency: 0 – 600 Hz

Short Circuit Current Rating (SCCR): 200 kA

Voltage Protection Rating (VPR), L-G: 800 V

Voltage Protection Rating (VPR), L-N: 700 V

Voltage Protection Rating (VPR), N-G: 600 V

Nominal Discharge Current (In), Per Mode: 20 kA 8/20 -s

Max Discharge Current (Imax), Per Phase: 320 kA 8/20 -s

Protection Modes: All modes protected

Status Indication: 1 green LED per line; Dual color status LED, flashing red for faults; Audible alarm

Remote Contact Switching Capacity: 2 A @ 240 V A

Remote Contacts: Yes

Lead Length: 36"

Lead Size: #10

Temperature: -40 to 185 °F

Enclosure Material: Polycarbonate

Enclosure Rating: NEMA®-4X; UL® 50E Type 4

Mounting: 3/4- straight nipple

Unit Weight: 1.38 lb

Certification Details: CSA C22.2 No. 269.2; UL® 1283 Edition 7; UL® 1449 Edition 5 Type 2, 20 kA Mode

Complies With: ANSI®/IEEE® C62.41.2-2002 Cat A, Cat B, Cat C; ANSI®/IEEE® C62.41.1-2002 Cat A, Cat B, Cat C; ANSI®/IEEE® C62.45-2002 Cat A, Cat B, Cat C; Mil-Std 220A

Depth (D): 2.99"

Height (H): 6.89"

Width (W): 8.38"

ADDITIONAL PRODUCT DETAILS

Optional Flush Plate available: SES320FP

DIAGRAMS

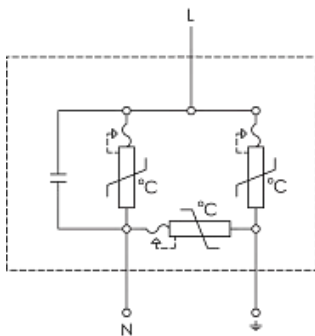

WARNING

nVent products shall be installed and used only as indicated in nVent's product instruction sheets and training materials. Instruction sheets are available at www.nvent.com and from your nVent customer service representative. Improper installation, misuse, misapplication or other failure to completely follow nVent's instructions and warnings may cause product malfunction, property damage, serious bodily injury and death and/or void your warranty.

North America

+1.800.753.9221

Option 1 – Customer Care

Option 2 – Technical Support

Europe

Netherlands:

+31 800-0200135

France:

+33 800 901 793

Europe

Germany:

800 1890272

Other Countries:

+31 13 5835404

APAC

Shanghai:

+ 86 21 2412 1618/19

Sydney:

+61 2 9751 8500



Our powerful portfolio of brands:
nVent.com CADDY ERICO HOFFMAN RAYCHEM SCHROFF
TRACER