

Vorläufige Daten  
preliminary data

**Key data**

2x 183A AC at 400V AC, forced air (fan not implemented)

**General information for:**

Stacks for various inverter application. Semiconductors, heat sinks, drivers and sensors included. These are only technical data!

Please read carefully the complete documentation and maintain the proper design environment! Especially note the EMC environment and the controller's functionality.

Topology	B2I
Application / Modulation	Inverter / Sine
Load type	resistive, inductive
Cooling	forced air (fan not implemented)
Market	common industrial, drives, power supply
Monitors	current, voltage, temperature
Semicond. (Unit 1)	none
DC Link	none
Semicond. (Unit 2)	2x FF300R12KS4
Interface IGBT	electrical CMOS
Standards	EN50178, UL94, prepared for UL508C
Product ID (eupec)	30699
Mechanical drawing number	38000030
Electrical drawing number	4PS-C3-V

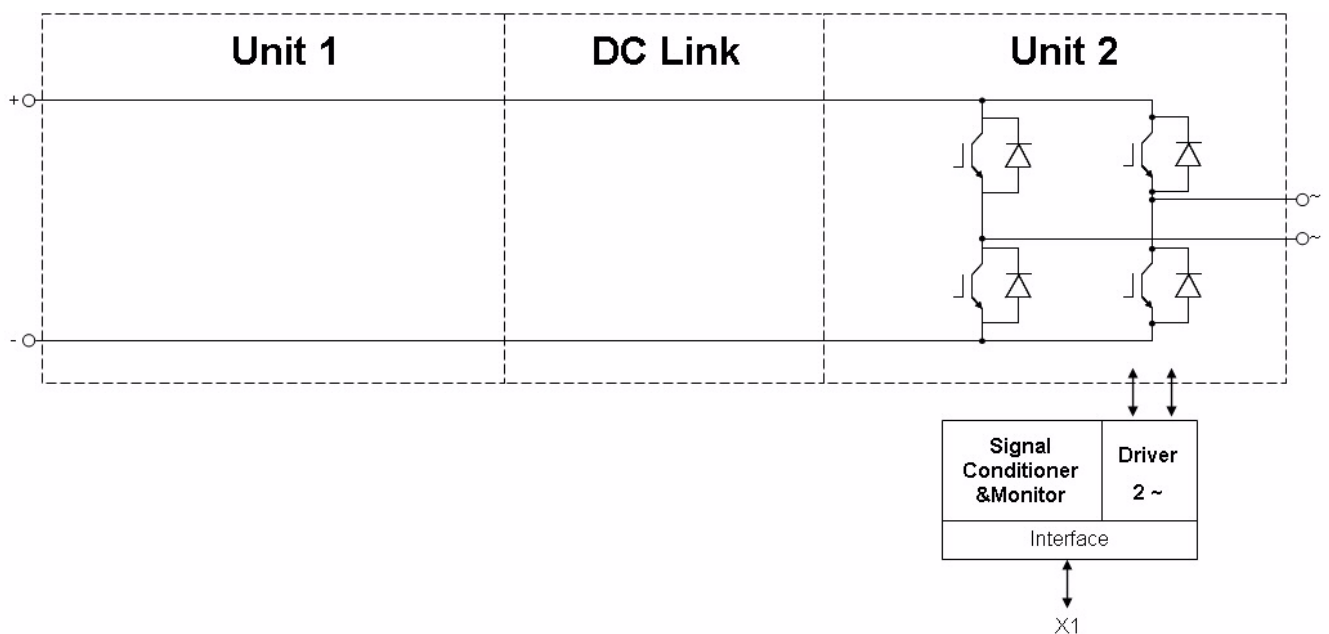
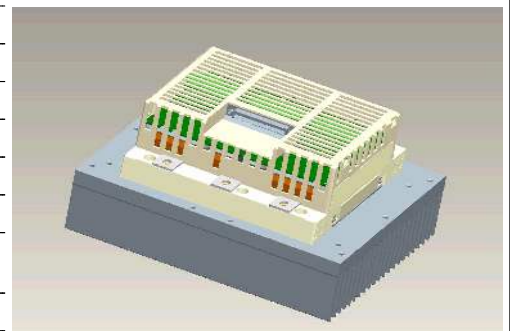

prepared by: Hoelbe Oliver	date of publication: 2007-11-10
approved by: Jürgen Schiele	revision: 2.0

# Technical Information

PrimeSTACK

# 4PS0300R12KS4-3GV



**Vorläufige Daten**  
**preliminary data**

## Notes

**Overvoltage shutdown:**  
**It must be realized by the customer.**  
**Overvoltage and Overcurrent shutdown reaction time:**  
**This parameter refers to the customers controller.**

## Electrical data

DC Link			min	typ	max	units
Voltage		V <sub>DC</sub>		650	850	V

Unit 2 AC			min	typ	max	units
Voltage	#ignore#	V <sub>Unit2</sub>		400		V <sub>RMS</sub>
Continuous current	V <sub>Unit2</sub> = 400V <sub>RMS</sub> , V <sub>DC</sub> = 650V, T <sub>inlet</sub> = 40°C, T <sub>J</sub> ≤ 125°C, f <sub>Unit2</sub> = 50Hz, f <sub>sw2</sub> = 5000Hz, cos(phi) = 0,85	I <sub>Unit2</sub>			183	A <sub>RMS</sub>
Continuous current overload cap.	T <sub>inlet</sub> = 40°C, for overload capability 150% for 60s			130		A <sub>RMS</sub>
Short time current	T <sub>inlet</sub> = 40°C, 10s, every 180s, initial load = 160A <sub>RMS</sub>	I <sub>Unit2</sub>			200	A <sub>RMS</sub>
Overcurrent shutdown	within 15µs			460		A <sub>peak</sub>
Switching frequency		f <sub>sw2</sub>			20000	Hz
Power losses	V <sub>Unit2</sub> = 400V, V <sub>DC</sub> = 650V, T <sub>inlet</sub> = 40°C, T <sub>J</sub> ≤ 125°C, f <sub>Unit2</sub> = 50Hz, f <sub>sw2</sub> = 5000Hz, cos(phi) = 0,85, I <sub>Unit2</sub> = 183A <sub>RMS</sub>	P <sub>loss2</sub>		1325		W
Power factor		cos(phi) <sub>Unit2</sub>	-1,00		1,00	

General data			min	typ	max	units
Power losses (PCB)		P <sub>loss aux</sub>			t.b.d.	W
EMC test	according to IEC61800-3 at named interfaces	power	V <sub>Burst</sub>	2		kV
		control	V <sub>Burst</sub>	1		kV
		aux (24V)	V <sub>Surge</sub>	1		kV
Insulation management is designed for		V <sub>Line</sub>		500		V <sub>RMS</sub>
Insulation test voltage	according to EN50178, f = 50Hz, t = 60s	V <sub>isol</sub>		1,8		kV <sub>RMS</sub>

prepared by: Hoelbe Oliver	date of publication: 2007-11-10
approved by: Jürgen Schiele	revision: 2.0

# Technical Information

PrimeSTACK

# 4PS0300R12KS4-3GV



## Vorläufige Daten preliminary data

### Controller interface data

			min	typ	max	units
Auxiliary voltage		$V_{aux}$	18	24	30	$V_{av}$
Auxiliary power requirement	$V_{aux} = 24V_{av}$	$P_{aux}$	40			W
Driver and interface board	see separate technical information		DR210			
Driver core			EiceDRIVER 2ED300C17-S			
Digital input level	resistor to GND 10,0k $\Omega$ , capacitor to GND 1nF, high = on, min 15mA	$V_{in}$	0,0		15,0	V
Digital output level	open collector, low = ok, max 15mA	$V_{out}$	0,0		30,0	V
Analog current outputs Unit 2	load max 1mA; at 183A	$V_{ana\ out}$	3,88	3,96	4,04	V
Analog DC Link voltage output	load max 1mA; at 850V	$V_{DC\ out}$	8,33	8,50	8,67	V
Analog temperature output	load max 1mA; at $T_{NTC} = 71^{\circ}C$ correspond to $T_j = 125^{\circ}C$	$V_{T\ out}$	7,61	7,77	7,93	V
Overvoltage shutdown reaction time	after overvoltage message by PrimeSTACK interface				50	$\mu s$
Overcurrent shutdown reaction time	after overvoltage message by PrimeSTACK interface				10	$\mu s$

### Heat sink air cooled / Thermal data

			min	typ	max	units
Airflow	$T_{Air} = 20^{\circ}C$ , $P_{air} = 1013hPa$ , dry- and dust free, measured on side of heat sink. according to DIN 41882	$\Delta V/\Delta t_{Air}$	500			$m^3/h$
Air pressure drop		$\Delta p_{Air}$		150		Pa
Cooling air inlet temperature	heat sink temperature $> -25^{\circ}C$	$T_{inlet}$	-25		40	$^{\circ}C$

### Environmental conditions

			min	typ	max	units
Storage temperature		$T_{stor}$	-40		85	$^{\circ}C$
Ambient temperature (PCB)		$T_{amp}$	-25		55	$^{\circ}C$
Operating temperature	see chapter Heat sink air cooled / Thermal data					
Cooling air velocity (PCB)		$V_{Air\ PCB}$	0,3			m/s
Air pressure	standard atmosphere	$p_{Air}$	900		1100	hPa
Humidity	no condensation	Rel. F	5		85	%
Installation height			0		1000	m
Vibration	according to IEC60721				5	$m/s^2$
Shock	according to IEC60721				40	$m/s^2$
Protection degree			IP00			
Pollution degree			2			
Torque at DC Terminals		$M_{DC}$	6,0		10,0	Nm
Torque at AC Terminals		$M_{AC}$	16,0		20,0	Nm
Dimensions	width $\times$ depth $\times$ height		216	280	167	mm
Weight with heat sink	approximation			9,1		kg
Weight without heat sink	approximation			2,9		kg

prepared by: Hoelbe Oliver	date of publication: 2007-11-10
approved by: Jürgen Schiele	revision: 2.0

Vorläufige Daten  
preliminary data

fo - derating curve IGBT (motor)  
cos(phi) = 0,85  
T<sub>cool medium</sub> = 40°C

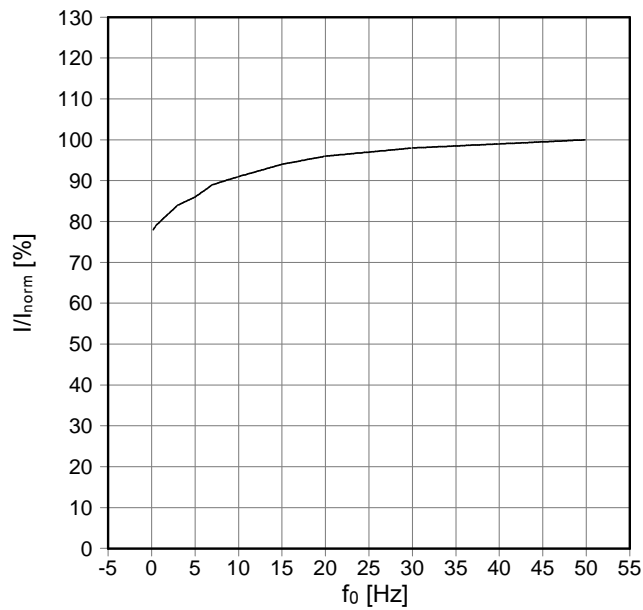

fsw - derating curve IGBT (motor)  
cos(phi) = 0,85  
T<sub>cool medium</sub> = 40°C

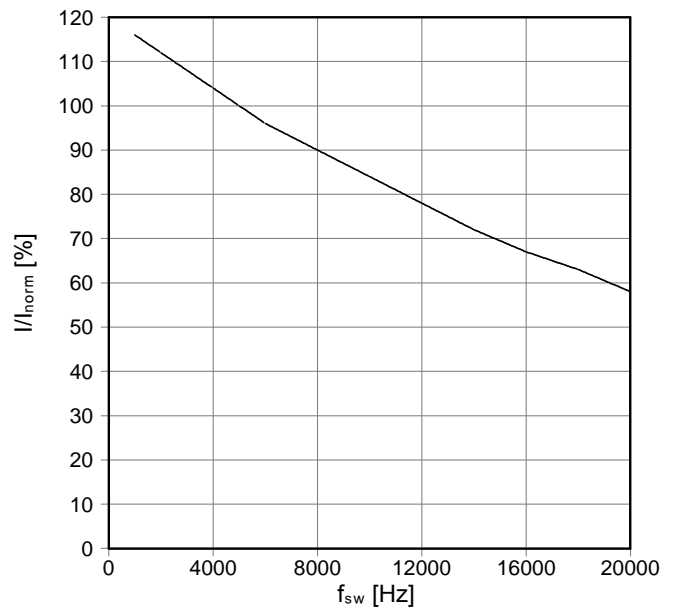

Transient thermal impedance per module  
T<sub>cool medium</sub> = 40°C

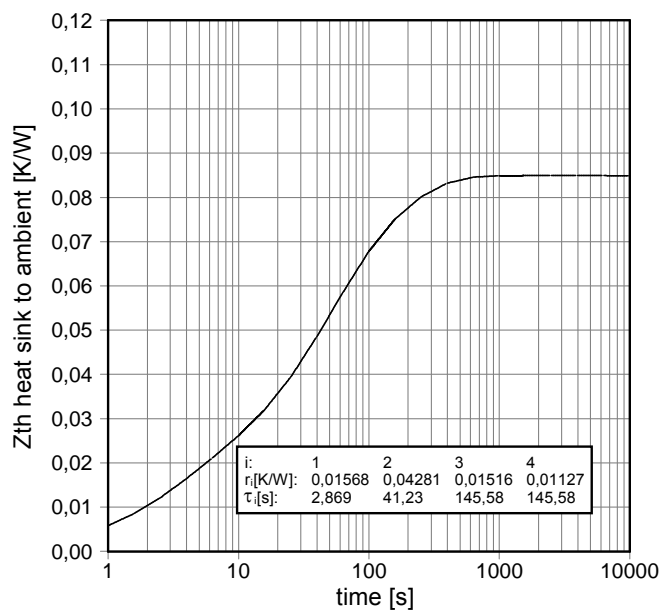

prepared by: Hoelbe Oliver	date of publication: 2007-11-10
approved by: Jürgen Schiele	revision: 2.0

Mechanical drawing

2PS...-3...  
4PS...-3...  
6PS...-3...  
PrimeSTACK C3  
38000030

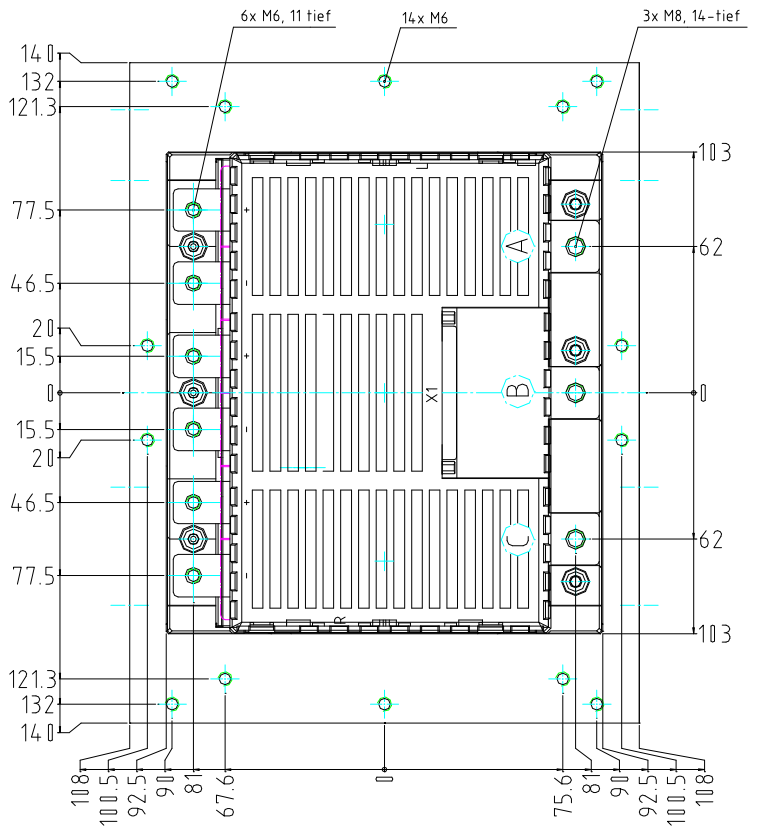
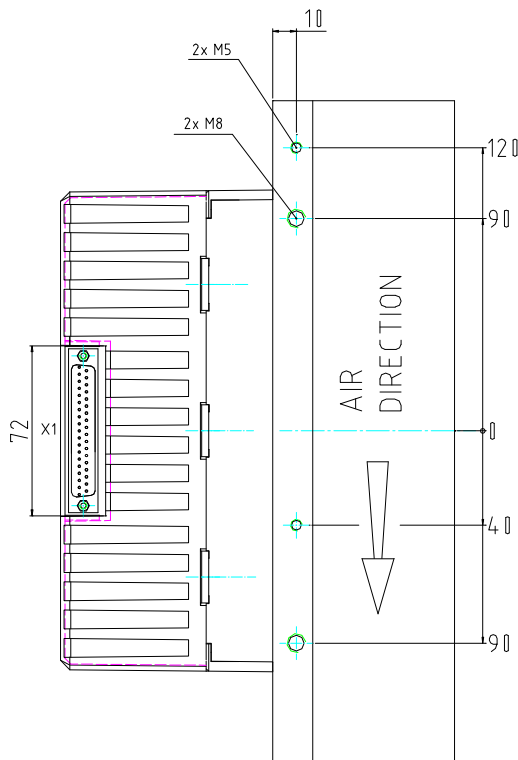
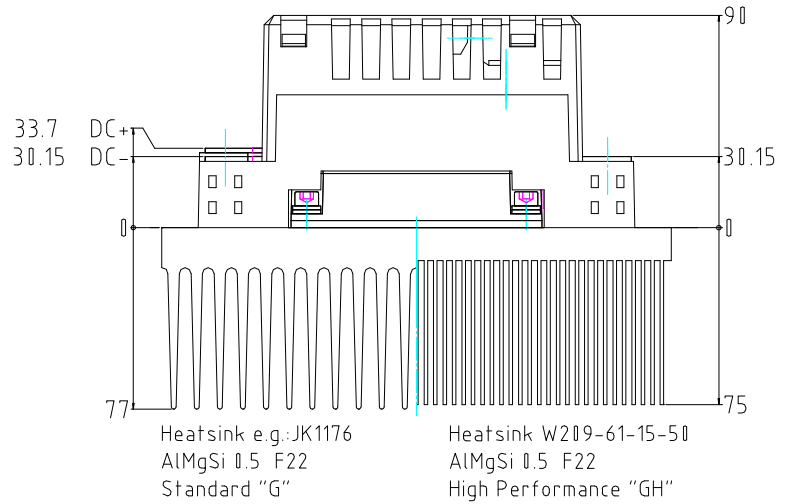

X1:

- 2PS : SUB-D-Connector 25 pole, male
- 6PS : SUB-D-Connector 37 pole, male

prepared by: Hoelbe Oliver	date of publication: 2007-11-10
approved by: Jürgen Schiele	revision: 2.0

Circuit diagram

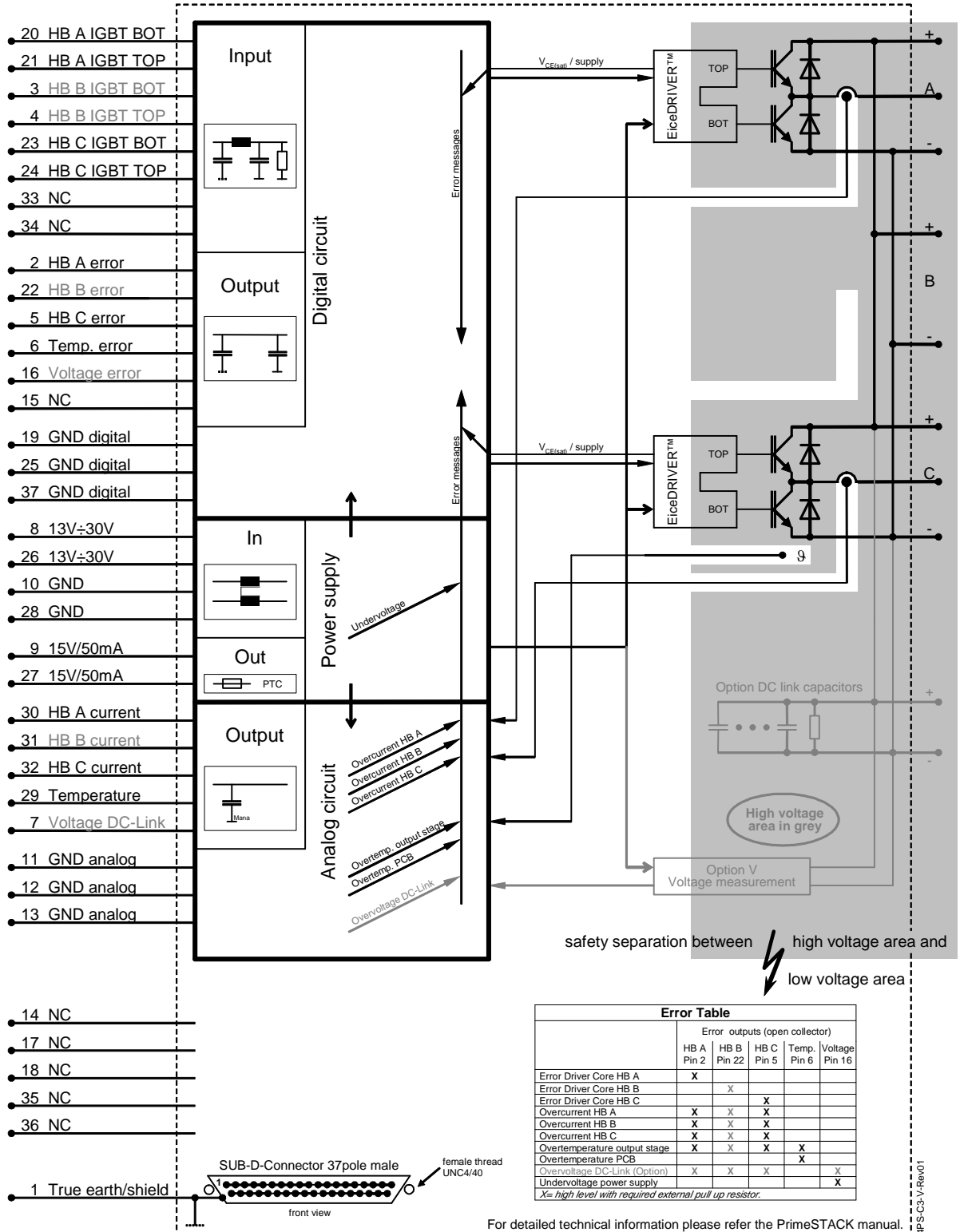

prepared by: Hoelbe Oliver      date of publication: 2007-11-10  
 approved by: Jürgen Schiele      revision: 2.0



**Nutzungsbedingungen**

Die in diesem Produktdatenblatt enthaltenen Daten sind ausschließlich für technisch geschultes Fachpersonal bestimmt. Die Beurteilung der Eignung dieses Produktes für Ihre Anwendung sowie die Beurteilung der Vollständigkeit der bereitgestellten Produktdaten für diese Anwendung obliegt Ihnen bzw. Ihren technischen Abteilungen.

In diesem Produktdatenblatt werden diejenigen Merkmale beschrieben, für die wir eine liefervertragliche Gewährleistung übernehmen. Eine solche Gewährleistung richtet sich ausschließlich nach Maßgabe der im jeweiligen Liefervertrag enthaltenen Bestimmungen. Garantien jeglicher Art werden für das Produkt und dessen Eigenschaften keinesfalls übernommen.

Sollten Sie von uns Produktinformationen benötigen, die über den Inhalt dieses Produktdatenblatts hinausgehen und insbesondere eine spezifische Verwendung und den Einsatz dieses Produktes betreffen, setzen Sie sich bitte mit dem für Sie zuständigen Vertriebsbüro in Verbindung (siehe [www.infineon.com](http://www.infineon.com), Vertrieb&Kontakt). Für Interessenten halten wir Application Notes bereit.

Aufgrund der technischen Anforderungen könnte unser Produkt gesundheitsgefährdende Substanzen enthalten. Bei Rückfragen zu den in diesem Produkt jeweils enthaltenen Substanzen setzen Sie sich bitte ebenfalls mit dem für Sie zuständigen Vertriebsbüro in Verbindung.

Sollten Sie beabsichtigen, das Produkt in Anwendungen der Luftfahrt, in gesundheits- oder lebensgefährdenden oder lebenserhaltenden Anwendungsbereichen einzusetzen, bitten wir um Mitteilung. Wir weisen darauf hin, dass wir für diese Fälle

- die gemeinsame Durchführung eines Risiko- und Qualitätsassessments;
- den Abschluss von speziellen Qualitätssicherungsvereinbarungen;
- die gemeinsame Einführung von Maßnahmen zu einer laufenden Produktbeobachtung dringend empfehlen und gegebenenfalls die Belieferung von der Umsetzung solcher Maßnahmen abhängig machen.

Soweit erforderlich, bitten wir Sie, entsprechende Hinweise an Ihre Kunden zu geben.

Inhaltliche Änderungen dieses Produktdatenblatts bleiben vorbehalten.

**Terms & Conditions of usage**

The data contained in this product data sheet is exclusively intended for technically trained staff. You and your technical departments will have to evaluate the suitability of the product for the intended application and the completeness of the product data with respect to such application.

This product data sheet is describing the characteristics of this product for which a warranty is granted. Any such warranty is granted exclusively pursuant the terms and conditions of the supply agreement. There will be no guarantee of any kind for the product and its characteristics.

Should you require product information in excess of the data given in this product data sheet or which concerns the specific application of our product, please contact the sales office, which is responsible for you (see [www.infineon.com](http://www.infineon.com), sales&contact). For those that are specifically interested we may provide application notes.

Due to technical requirements our product may contain dangerous substances. For information on the types in question please contact the sales office, which is responsible for you.

Should you intend to use the Product in aviation applications, in health or live endangering or life support applications, please notify. Please note, that for any such applications we urgently recommend

- to perform joint Risk and Quality Assessments;
- the conclusion of Quality Agreements;
- to establish joint measures of an ongoing product survey, and that we may make delivery depended on the realization of any such measures.

If and to the extent necessary, please forward equivalent notices to your customers.

Changes of this product data sheet are reserved.

prepared by: Hoelbe Oliver	date of publication: 2007-11-10
approved by: Jürgen Schiele	revision: 2.0



**Vorläufige Daten  
preliminary data**

**Sicherheitshinweise**

Bevor Sie mit der Installation und dem Betrieb der Baugruppe beginnen, lesen Sie bitte sorgfältig alle Sicherheitshinweise, Warnungen und beachten Sie die angebrachten Warnschilder. Vergewissern Sie sich, dass alle Warnschilder in leserlichem Zustand verbleiben und fehlende oder beschädigte Schilder ersetzt werden.

**Safety Instructions**

Prior to installation and operation, all safety notices and warnings and all warning signs attached to the equipment have to be carefully read. Make sure that all warning signs remain in a legible condition and that missing or damaged signs are replaced. To installation and operation, all safety notices and warnings and all warning signs attached to the equipment have to be carefully read. Make sure that all warning signs remain in a legible condition and that missing or damaged signs are replaced.

prepared by: Hoelbe Oliver	date of publication: 2007-11-10
approved by: Jürgen Schiele	revision: 2.0