



Features

- ESD Protect for 1 Line with Bi-directional
- Provide ESD protection for the protected line to **IEC 61000-4-2 (ESD) $\pm 16\text{kV}$ (air/contact) Cable Discharge Event (CDE)**
- 0402 small DFN package saves board space
- Protect one I/O line or one power line
- Fast turn-on and Low clamping voltage
- For low operating voltage applications: 3.3V maximum
- Solid-state silicon-avalanche and active circuit triggering technology
- **Green part**
- **AEC-Q101 qualified**

Applications

- Mobile Phones
- Hand Held Portable Applications
- Computer Interfaces Protection
- Microprocessors Protection
- Serial and Parallel Ports Protection
- Control Signal Lines Protection
- Power lines on PCB Protection
- Latchup Protection

Description

AZ9523-01F is a design which includes one Bi-directional surge rated clamping cell to protect one power line, or one control line, or one low speed data line in an electronic systems. The AZ9523-01F has been specifically designed to protect sensitive components which are connected to power and control lines from over-voltage damage and latch-up caused by Electrostatic Discharging (ESD), and Cable Discharge Event (CDE).

AZ9523-01F is a unique design which includes proprietary clamping cell in a single package. During transient conditions, the proprietary clamping cell prevents over-voltage on the power line or control/data lines, protecting any downstream components.

AZ9523-01F may be used to meet the ESD immunity requirements of IEC 61000-4-2, Level 4 ($\pm 15\text{kV}$ air, $\pm 8\text{kV}$ contact discharge)

Circuit Diagram / Pin Configuration

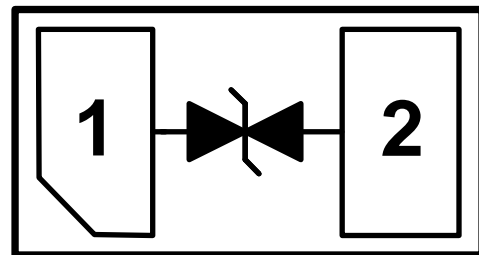

DFN1006P2X (Bottom View)
(1.0mm x 0.6mm x 0.45mm)



SPECIFICATIONS

ABSOLUTE MAXIMUM RATINGS			
PARAMETER	SYMBOL	RATING	UNITS
Operating Supply Voltage	V_{DC}	± 3.6	V
ESD per IEC 61000-4-2 (Air)	V_{ESD}	± 16	kV
ESD per IEC 61000-4-2 (Contact)		± 16	
Lead Soldering Temperature	T_{SOL}	260 (10 sec.)	$^{\circ}C$
Operating Temperature	T_{OP}	-55 to +125	$^{\circ}C$
Storage Temperature	T_{STO}	-55 to +150	$^{\circ}C$

ELECTRICAL CHARACTERISTICS						
PARAMETER	SYMBOL	CONDITIONS	MINI	TYP	MAX	UNITS
Reverse Stand-Off Voltage	V_{RWM}	$T=25^{\circ}C$	-3.3		3.3	V
Leakage Current	I_{Leak}	$V_{RWM} = \pm 3.3V, T=25^{\circ}C$			1.0	μA
Breakdown Voltage	V_{BV}	$I_{BV} = 1mA, T=25^{\circ}C$	4		6.8	V
ESD Clamping Voltage (Note 1)	V_{ESD_CL}	IEC 61000-4-2 +8kV ($I_{TLP} = 16A$), Contact mode, $T=25^{\circ}C$, pin-1 to pin-2		7		V
ESD Dynamic Turn-on Resistance	$R_{dynamic}$	IEC 61000-4-2 0~+8kV, $T=25^{\circ}C$, Contact mode, pin-1 to pin-2		0.1		Ω
Channel Input Capacitance	C_{IN}	$V_R = 0V, f = 1MHz, T=25^{\circ}C$		15	18	pF

Note 1: ESD Clamping Voltage was measured by Transmission Line Pulsing (TLP) System.

TLP conditions: $Z_0 = 50\Omega, t_p = 100ns, t_r = 2ns$.



Typical Characteristics

Transmission Line Pulsing (TLP) Measurement

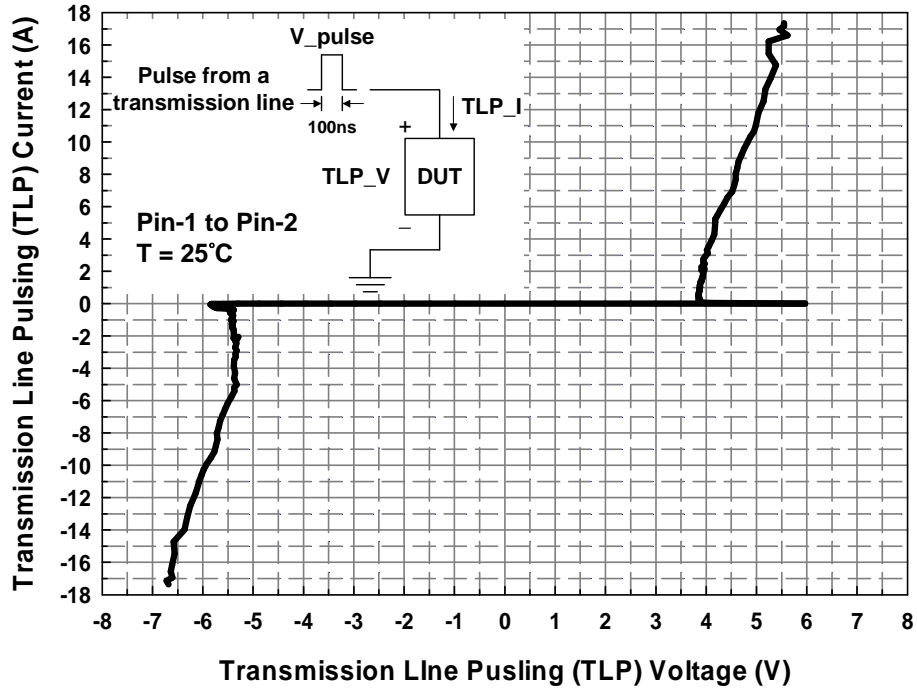

Typical Variation of C_{IN} vs. V_{IN}

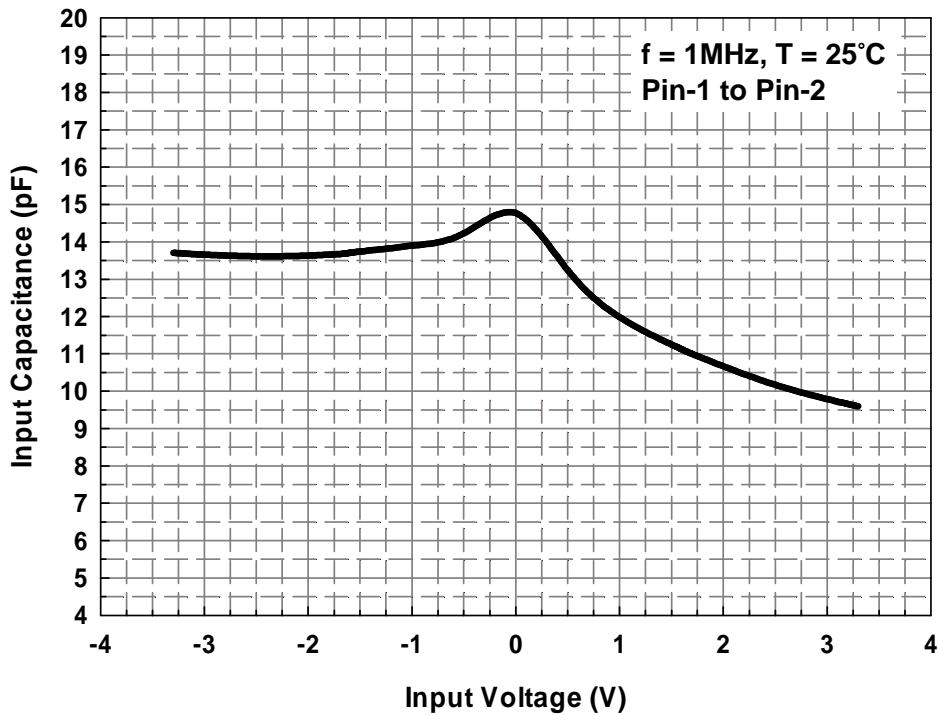



Applications Information

The AZ9523-01F is designed to protect one line against System ESD/CDE pulses by clamping them to an acceptable reference. It provides bi-directional protection.

The usage of the AZ9523-01F is shown in Fig. 1. Protected line, such as data line, control line, or power line, is connected at pin 1. The pin 2 is connected to a ground plane on the board. In order to minimize parasitic inductance in the board traces, all path lengths connected to the pins of AZ9523-01F should be kept as short as possible.

In order to obtain enough suppression of ESD induced transient, good circuit board is critical. Thus, the following guidelines are recommended:

- Minimize the path length between the protected lines and the AZ9523-01F.
- Place the AZ9523-01F near the input terminals or connectors to restrict transient coupling.
- The ESD current return path to ground should be kept as short as possible.
- Use ground planes whenever possible.
- NEVER route critical signals near board edges and near the lines which the ESD transient easily injects to

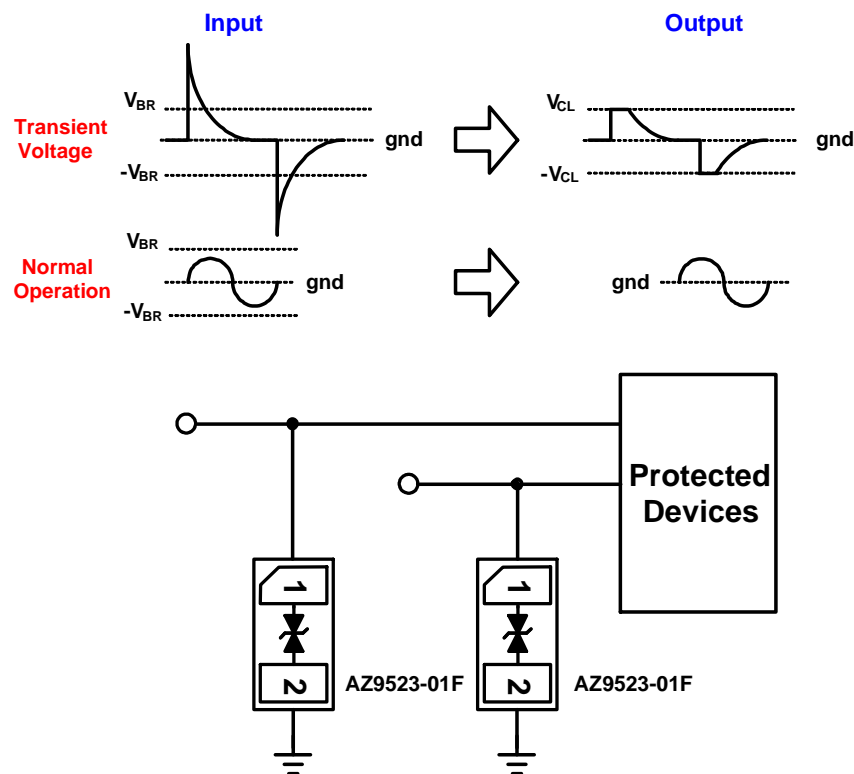

Fig. 1 ESD protection scheme by using AZ9523-01F.



Mechanical Details

DFN1006P2X

PACKAGE DIAGRAMS

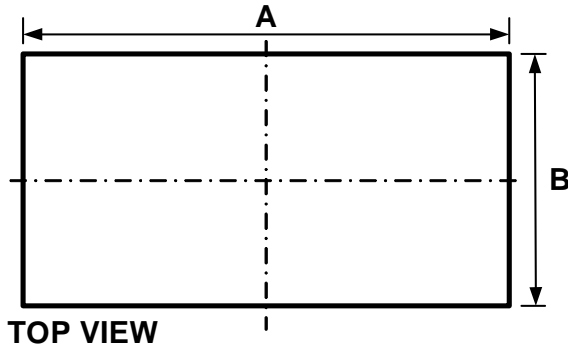

TOP VIEW



SIDE VIEW

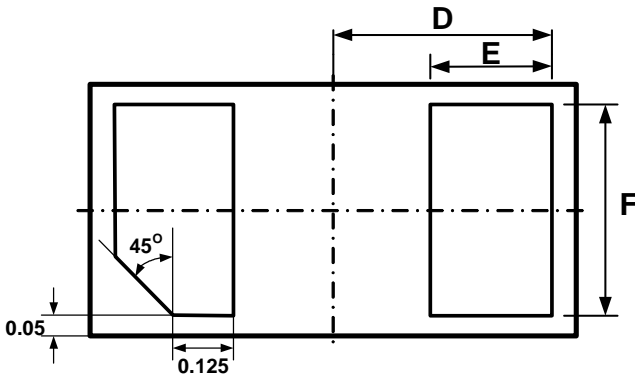

BOTTOM VIEW

PACKAGE DIMENSIONS

Symbol	Millimeters		Inches	
	min	max	min	max
A	0.95	1.05	0.037	0.041
B	0.55	0.65	0.022	0.026
C	0.41	0.55	0.016	0.022
D	0.45		0.018	
E	0.20	0.30	0.008	0.012
F	0.45	0.55	0.018	0.022

LAND LAYOUT

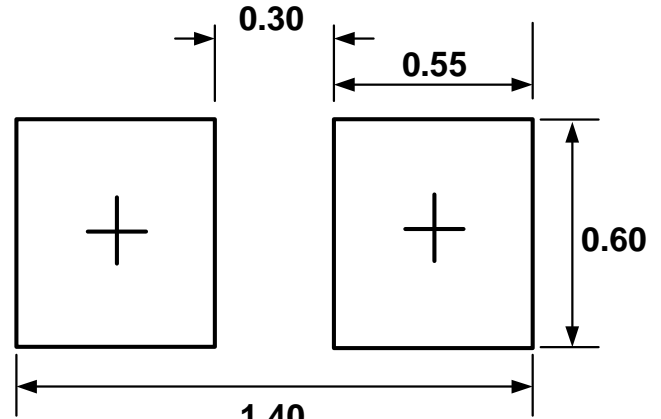

(Unit: mm)

Notes:

This LAND LAYOUT is for reference purposes only. Please consult your manufacturing partners to ensure your company's PCB design guidelines are met.

MARKING CODE

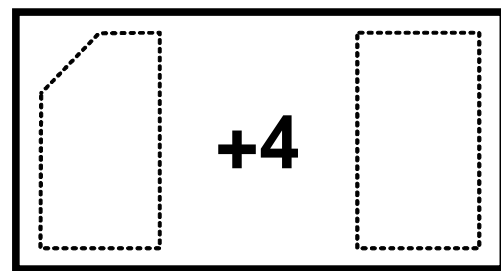

Top View

Part Number	Marking Code
AZ9523-01F (Green Part)	4

Note. Green means Pb-free, RoHS, and Halogen free compliant.



Ordering Information

PN#	Material	Type	Reel size	MOQ	MOQ/internal box	MOQ/carton
AZ9523-01F.R7GR	Green	T/R	7 inch	12,000/reel	4 reel=48,000/box	6 box=288,000/carton

Revision History

Revision	Modification Description
Revision 2015/02/04	Preliminary release.
Revision 2015/05/27	Formal release.