

bq2425xEVM-150, Single-Cell Li-Ion Switch-Mode Charger

This user's guide describes the characteristics, operation, and use of the bq24250EVM-150, bq24251EVM-150, and bq24257EVM-150 evaluation modules (EVM). These EVMs enable test and evaluation TI's bq24250, bq24251, and bq24257 devices. The bq2425x series are highly integrated, single-cell, Li-Ion battery chargers targeted for space-limited, portable applications with high-capacity batteries. This user's guide includes EVM specifications, the schematic diagram, test procedures, test results, a bill of materials, and board layout.

Contents

1	Introduction	2
2	EVM Considerations	3
3	Recommended Operating Condition	3
4	Equipment and EVM Setup	4
	4.1 Schematic	4
	4.2 I/O Description	5
	4.3 Test Points	5
	4.4 Pin Descriptions	6
	4.5 Control and Key Parameters Setting	6
5	Test Procedure	7
	5.1 Definition	7
	5.2 Recommended Test Equipment	7
	5.3 Software	7
	5.4 Recommended Test Equipment Set Up	8
	5.5 Recommended Test Procedure	10
6	Test Results	12
	6.1 Output Regulation Ripple	12
	6.2 Efficiency Data	12
	6.3 Thermal Performance	13
7	Layout and Bill of Materials	13
	7.1 Printed-Circuit Board Layout Guideline	13
	7.2 Layout	14
	7.3 Bill of Materials (BOM)	20

List of Figures

1	bq2425xEVM-150 Schematic	4
2	Original Test Setup	8
3	Battery Emulator	9
4	Connector Kit	9
5	Main Window of the bq2425xSW Evaluation Software	10
6	Output Regulation Ripple at ICHG = 1000 mA	12
7	Output Regulation Ripple at ICHG = 120 mA	12
8	Efficiency Versus Output Current While in Battery Voltage Regulation (4.2V) [®]	12
9	Thermal Image	13
10	bq2425xEVM-150 Top Assembly	14
11	bq2425xEVM-150 Top Silkscreen	15

[®] is a trademark of NXP.

12	bq2425xEVM-150 Top Layer	16
13	bq2425xEVM-150 Second Layer (Internal) Routine	17
14	bq2425xEVM-150 Third Layer (Internal) Routine	18
15	bq2425xEVM-150 Bottom Layer	19

List of Tables

1	Connector and Test Points	5
2	Test Points Description.....	5
3	Pin Descriptions	6
4	Control and Key Parameters	6
5	bq2425xEVM-150 Bill of Materials	20

1 Introduction

The bq24250, bq24251, and bq24257 devices are highly-integrated, single-cell, Li-Ion battery chargers with integrated current sense resistors targeted for space-limited, portable applications with high-capacity batteries. The single-cell charger has a single input that operates from either a USB port or AC wall adapter for a versatile solution. BC1.2-compliant D+/D– detection allows for recognition of CDP, DCP, SDP, and non-standard USB adapters. The use of an accessory dead-battery provision (DBP) pin allows for the system to sync a dead battery state in order to enable/disable the BC1.2 detection in the case of an external USB-PHI.

The bq24250, bq24251, and bq24257 devices have two modes of operation: 1) I²C™ mode, and 2) standalone mode. In I²C mode, the host adjusts the charge parameters and monitors the status of the charger operation. In standalone mode, the external resistor sets the input-current limit, and charge-current limit. Standalone mode also serves as the default settings when a DCP adapter is present. They enter host mode while the I²C registers are accessed and the watchdog timer has not expired (if enabled).

The battery is charged in four phases: trickle charge, pre-charge, constant current and constant voltage. In all charge phases, an internal control loop monitors the IC junction temperature and reduces the charge current if the internal temperature threshold is exceeded.

The bq24250 and bq24251 have system power path management. This feature allows this device to power the system from a high efficiency DC/DC converter while simultaneously and independently charging the battery. The charger monitors the battery current at all times and reduces the charge current when the system load requires current above the input current limit. This allows for proper charge termination and enables the system to run with a defective or absent battery pack. Additionally, this enables instant system turn-on even with a totally discharged battery or no battery. The power-path management architecture also permits the battery to supplement the system current requirements when the adapter cannot deliver the peak system currents. This enables the use of a smaller adapter.

2 EVM Considerations

Refer to the data sheet for specific details on the charger ICs. The bq24250, bq24251, and bq24257 devices are featured with a high-efficiency switch-mode charger. It has integrated power FETs able to charge at up to a 2-A charging rate, and an integrated 50-mA LDO. In I²C mode, the bq24250, bq24251, and bq24257 devices have programmable battery charge voltage (V_{BATREG}), charge current (I_{CHG}), input current limit (I_{LIM}), and input over-voltage protection threshold (V_{OVP}).

The charge current and the input current limit are programmed using external resistors (R_{ISET} and R_{ILIM}) connected from the ISET and ILIM pins to ground. The range of these resistors can be found in the datasheet. Both of these currents can be programmed up to 2 A. The bq24250, bq24251, and bq24257 devices also have complete system-level protection such as input undervoltage lockout (UVLO), input over-voltage protection (OVP), battery OVP, sleep mode, thermal regulation and thermal shutdown, voltage-based JEITA-compatible NTC monitoring input, and safety timer. PSE is also available – notify your local TI representative.

3 Recommended Operating Condition

Specification	Test Condition	Min	Typ	Max	Units
Input DC voltage, VIN	Recommended input voltage range	4.35		10.5	V
Input current	Recommended input current range			2	A
Charge current	Fast charge current range	0.5		2	A
Output regulation voltage	Standalone mode or I ² C default mode		4.2		V
Output regulation voltage	I ² C host mode: operating in voltage regulation, programmable range	3.5		4.44	V
LDO	LDO output voltage		4.9		V

4.2 I/O Description

This EVM is designed to operate over the full input voltage range. Refer to [Table 1](#) for I/O connector descriptions:

Table 1. Connector and Test Points

Header or Terminal Block	Description
J1: Micro-USB	Micro USB connector
J2: IN	Positive input power supply
J4: GND	Ground input power supply
J3: DC IN	Input power supply (terminal block)
J5: BAT	Positive battery pack terminal
J7:GND	Negative battery pack terminal
J6: BATand GND	Battery pack terminal (terminal block)
J11: LDO	Positive LDO terminal
J13: GND	Ground LDO terminal
J12: LDO and GND	LDO terminal block
J8: CSIN/SYS	Positive system terminal
J10: GND	Negative system terminal
J9: SYS/CSIN and GND	System terminal block
J14	Digital connector
J15: TS and GND	TS terminal block

4.3 Test Points

[Table 2](#) provides the descriptions for the test points in the EVM.

Table 2. Test Points Description

Test Point	Description
TP1	SW
TP2	BAT
TP3	GND K
TP4	CSIN/SYS
TP5	IN
TP6	STAT
TP7	GND
TP8	PG/INT
TP9	SCL
TP10	SDA
TP11	ISET
TP12	ILIM
TP13	VDPM
TP14	BOOT
TP15	PMID

4.4 Pin Descriptions

Pin descriptions for the EVM are listed in [Table 3](#).

Table 3. Pin Descriptions

PIN Number	bq24250	bq24251	bq24257
	YFF	YFF	YFF
A1,B1,C1	BAT	BAT	BAT
A2,B2,C2	SYS	SYS	CSIN
A3,B3,C3	PGND	PGND	PGND
A4,B4,C4	SW	SW	SW
A5,B5,C5	IN	IN	IN
D1	ISET	ISET	ISET
D2	EN2	D-	D-
D3	EN1	D+	D+
D4	\overline{CE}	\overline{CE}	\overline{CE}
D5	PMID	PMID	PMID
E1	INT	\overline{PG}	\overline{PG}
E2	SCL	SCL	SCL
E3	STAT	STAT	STAT
E4	VDPM	VDPM	VDPM
E5	BOOT	BOOT	BOOT
F1	TS	TS	TS
F2	SDA	SDA	SDA
F3	PGND	PGND	PGND
F4	LDO	LDO	LDO
F5	ILIM	ILIM	ILIM

4.5 Control and Key Parameters Setting

[Table 4](#) lists and describes the jumpers on the EVM.

Table 4. Control and Key Parameters

Jumpers	Description
JP1	Shorting Jumper D+/EN1 and D-/EN2
JP2	2-3 (D+/EN1 = HI): D+/EN1 to logic high 2-1 (D+/EN1 = LO): D+/EN1 to logic low
JP3	2-3 (CE = HI): To place the battery charger in standby mode. 2-1 (CE = LO): Charge enable
JP4	2-3 (TS = Variable): Connect TS pin to variable resistor 2-1 (TS = Fixed): Connect TS pin to fixed resistor
JP5	2-3 (D-/EN2 = HI): D-/EN2 to logic high 2-1 (D-/EN2 = LO): D-/EN2 to logic low
JP6	2-3 (SCL = HI): SCL to logic high 2-1 (SCL = LO): SCL to logic low
JP7	2-3 (SDA = HI): SCL to logic high 2-1 (SDA = LO): SCL to logic low
JP8	Shorting jumper connects CE to J14
JP9	Shorting jumper connects D+/EN1 to J14
JP10	Shorting jumper connects D-/EN2 to J14

5 Test Procedure

This procedure describes the test configuration of the EVM for bench evaluation.

5.1 Definition

The following naming conventions are followed:

VXXX: External voltage supply name (VADP, VBT, VSBT)

LOADW: External load name (LOADR, LOADI)

V(TPyy): Voltage at internal test point TPyy. For example, V(TP02) means the voltage at TP02

V(Jxx): Voltage at header Jxx

V(TP(XXX)): Voltage at test point XXX. For example, V(ACDET) means the voltage at the test point which is marked as ACDET.

V(XXX, YYY): Voltage across point XXX and YYY

I(JXX(YYY)): Current going out from the YYY terminal of header XX

Jxx(BBB): Terminal or pin BBB of header xx

JPx ON: Internal jumper Jxx terminals are shorted

JPx OFF: Internal jumper Jxx terminals are open

JPx (-YY-) ON: Internal jumper Jxx adjacent terminals marked as YY are shorted

Assembly drawings show the location for jumpers, test points, and individual components.

5.2 Recommended Test Equipment

The following list includes the equipment and requirements necessary to perform all the tests in the test procedure:

- Power supply #1 (PS #1) capable of supplying 12 V at 3 A
- Power supply #2 (PS #2) capable of supplying up to 5 V at 5 A to power the battery emulator
- A computer with at least one USB port and a USB cable
- Properly installed bq2425x evaluation software
- A HPA172 USB-to-I2C communication kit
- Three voltage meters (VM)
- Two equivalent current meters (A) able to measure 3-A current

5.3 Software

Download BQ2425xSW.zip from the charger's product folder, unzip the file, and double-click on the SETUP.EXE file. Follow the installation steps. Because the bq2425x has the watchdog timer enabled, by default, it is recommended to set the **WD Timer Periodic Reset** to 1 s, if it is desired to operate in host mode. If standalone mode is desired, uncheck the **Enable WD Timer** while the device is only powered off the battery. This mode of operation is important when evaluating the D+/D- detection function (only active in standalone mode).

Also, it is generally helpful to activate the **Write On Change** functions, in the upper left of the GUI window, to ON. The **Write On Change** function writes any changes to the GUI's check boxes, drop-down boxes, and registers to the IC. Otherwise, click the **WRITE** button to write changes to the software. Click the **READ** button periodically to find the IC's instantaneous status.

Note that all devices in the bq2425x family include a safety timer. If the time indicated in the **Safety Timer Time Limit** elapses, charging discontinues. If this occurs, a power reset or battery removal is required.

5.4 Recommended Test Equipment Set Up

1. For all power connections, use short, twisted-pair wires of appropriate gauge wire for the amount of the current (handles 3 A).
2. Set power supply #1 (PS #1) for 6-V, 3-A current limit, then turn off supply.

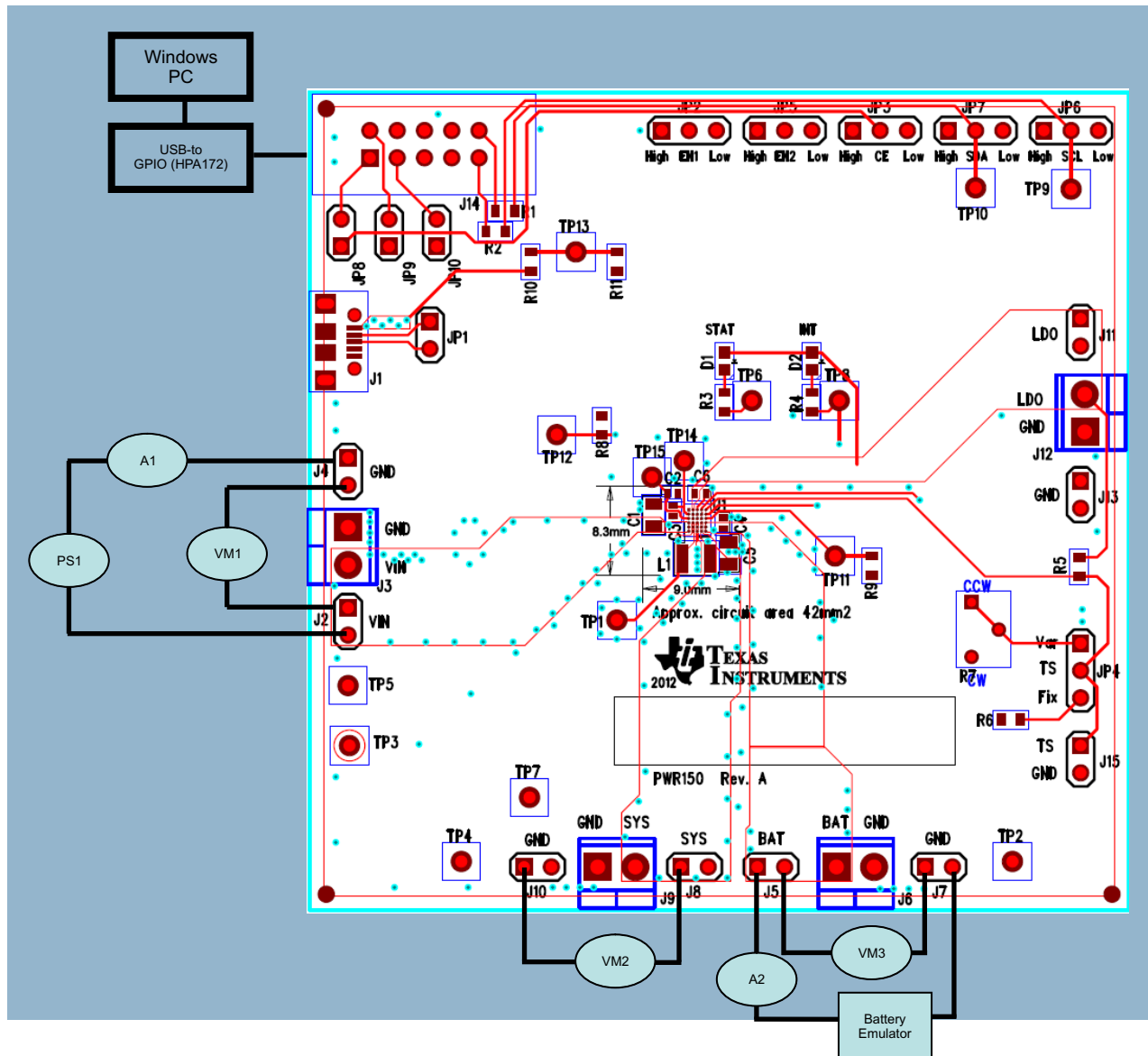

Figure 2. Original Test Setup

- Adjust power supply #2 (PS #2) for approximately 3.6 V to the input side (PS #2±) of the battery emulator shown in [Figure 3](#), then turn off PS #2.

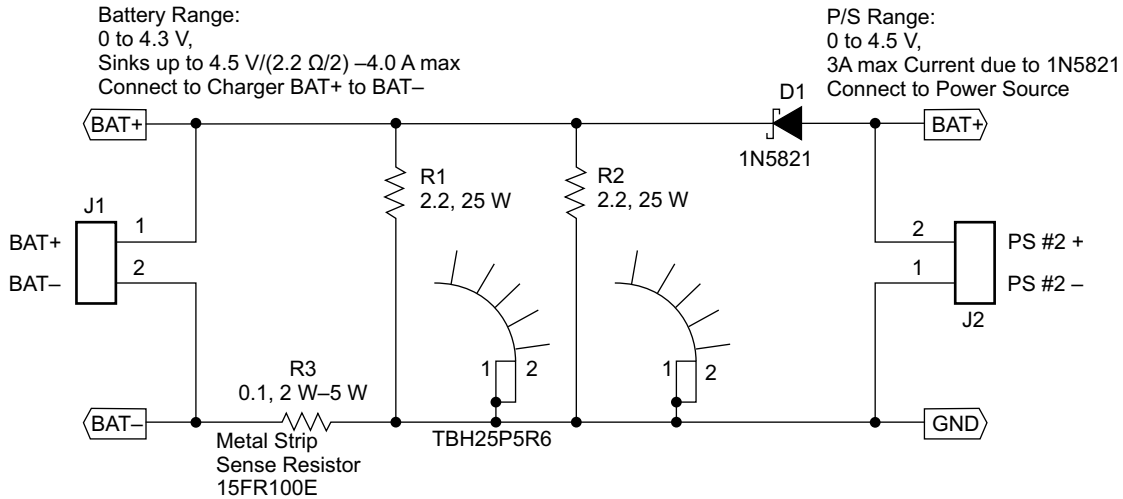

Figure 3. Battery Emulator

- Connect the output side of the battery or battery emulator in series with the current meter to J5 and J7 or J6 (BAT, GND).
- Connect a voltmeter (VM#2) across J8 and J10 (SYS test point, GND).
- Connect VM#3 across J5 and J7 (BAT, GND)
- Connect J14 to the HPA172 kit with the 10-pin ribbon cable. Connect the USB port of the HPA172 kit to the USB port of the computer. The connections are shown in [Figure 4](#).

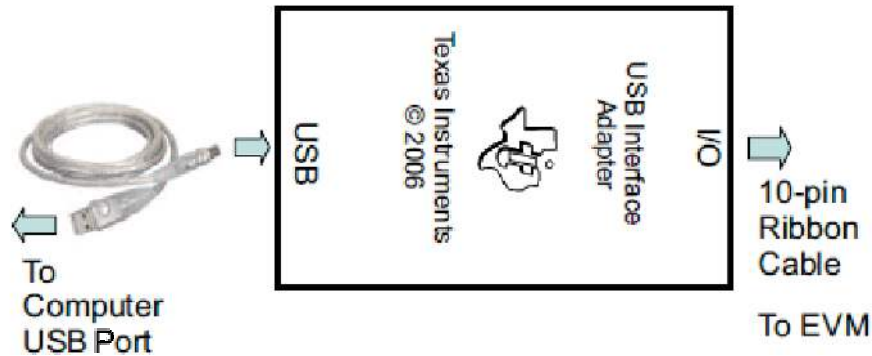

Figure 4. Connector Kit

- By default, all jumpers are set to operate upon arrival.
- After the preceding steps have been performed, the test setup for PWR150 is configured as is shown in [Figure 2](#).

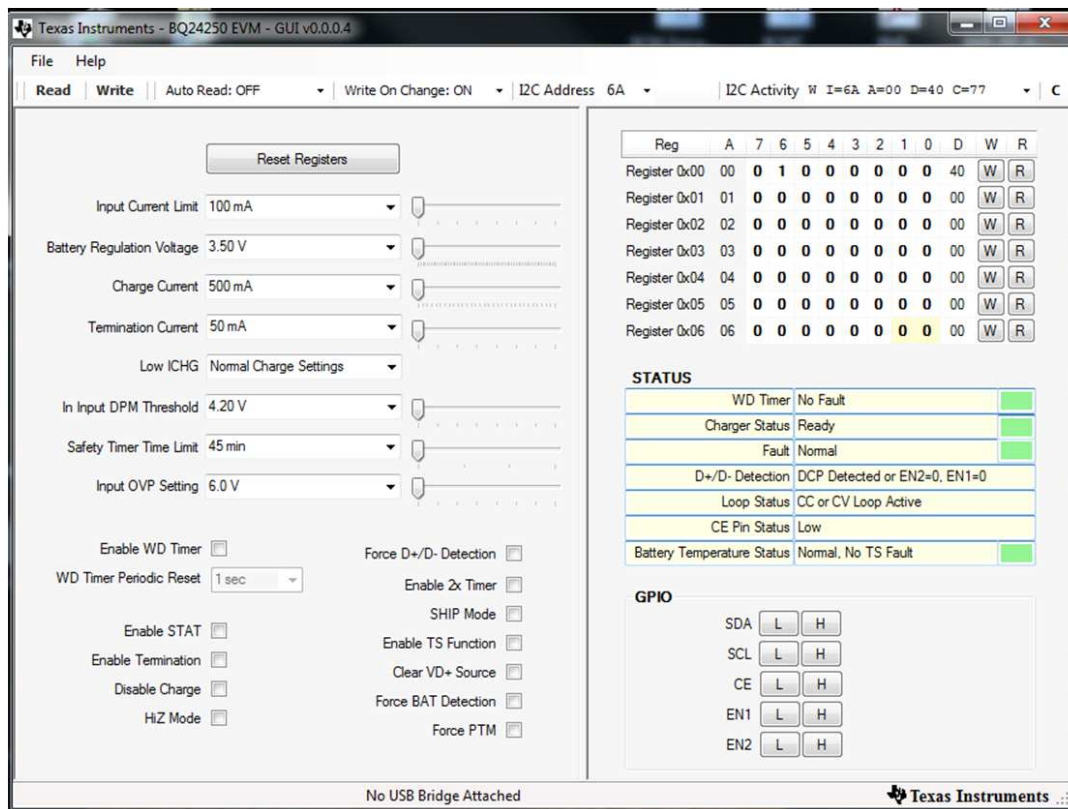

Figure 5. Main Window of the bq2425xSW Evaluation Software

10. Turn on the computer. Open the bq2425x evaluation software. The main window of the software is shown in Figure 5.

5.5 Recommended Test Procedure

5.5.1 Charge Voltage and Charge Regulation in Default Mode

1. Ensure that the recommended test setup is followed.
2. Connect the output of PS #1 in series with current meter (A #1) to J2 and J4 (IN, GND).
3. Connect VM #1 across J4 and J2 (IN, GND).
4. Ensure the \overline{CE} is low by shorting JP3 to GND.
5. Turn on PS #1 and PS #2.
6. Enable PS #2 or equivalent battery and adjust PS #2 so that the voltage measured by VM #3, across BAT and GND, measures 3.6 V \pm 50 mV.
7. Adjust the power supply so VM #1 still reads 6 V \pm 100 mV and VM#3 reads 3.2 V.
 - Measure on A #2 $\rightarrow I_{CHRG} = 1000 \text{ mA} \pm 150 \text{ mA}$
 - Measure on A #1 $\rightarrow I_{IN} = 600 \text{ mA} \pm 100 \text{ mA}$

5.5.2 Input and Charge Current Regulation in Host Mode

1. Ensure that the recommended test setup is followed.
2. Follow Section 6 for initial setup
3. Open the bq2425x software:
 - Press the **READ** button to obtain the current settings.
 - Change the **Input Current Limit** to 100 mA

- Adjust VBAT to 3.6 V
 - Measure on A #2 → $I_{\text{CHRG}} = 120 \text{ mA} \pm 20 \text{ mA}$
 - Measure on A #1 → $I_{\text{IN}} = 100 \text{ mA} \pm 20 \text{ mA}$
- Change the **Charge Current** to 1000 mA and the **Input Current Limit** to 900 mA and **Battery Regulation Voltage** to 4.2 V
- Adjust VBAT to 3.6 V
 - Measure on A #2 → $I_{\text{CHRG}} = 1000 \text{ mA} \pm 100 \text{ mA}$
 - Measure on A #1 → $I_{\text{IN}} = 650 \text{ mA} \pm 50 \text{ mA}$
 - Measure on V #3 → $V_{\text{BAT}} = 3.6 \text{ V} \pm 10 \text{ mV}$
 - Measure on V #2 → $V_{\text{SYS}} = 3.64 \text{ V} \pm 30 \text{ mV}$
 - Make sure D1 and D2 are ON (STAT and INT)
- Change JP4 to jumper shorting pin TS and Var
- Measure TS pin on JP15 as you change the value of the potentiometer R7
- Change R7 until $V_{\text{TS}} = 3 \text{ V}$
 - Measure on A #2 → $I_{\text{CHRG}} = 0 \text{ mA} \pm 20 \text{ mA}$
- Change R7 until $V_{\text{TS}} = 2.5 \text{ V}$
 - Measure on A #2 → $I_{\text{CHRG}} = 1000 \text{ mA} \pm 30 \text{ mA}$
- Change R7 until $V_{\text{TS}} = 1 \text{ V}$
 - Measure on A #2 → $I_{\text{CHRG}} = 0 \text{ mA} \pm 20 \text{ mA}$
- Change JP4 back to jumper shorting pin TS and Fix

5.5.3 D+/D– Detection in Standalone Mode (ONLY for bq24251 and bq24257)

1. Ensure that the recommended test setup is followed
2. Follow [Section 6](#) for initial setup
3. Ensure the $\overline{\text{CE}}$ is low by shorting JP3 to GND and jumper shorting pin TS and Fix.
4. Enable PS #2 or equivalent battery and adjust PS #2 so that the voltage measured by VM #3, across BAT and GND, measures $3.2 \text{ V} \pm 50 \text{ mV}$
5. Remove the jumper at JP1, if present
6. Adjust VBAT to 3.2 V
7. Use a standard USB-to-micro-USB cable and plug in from a computer USB port to the micro-USB port on the EVM (J1)
 - Measure on A #2 → $I_{\text{CHRG}} = 110 \text{ mA} \pm 10 \text{ mA}$
 - Now we are in dead battery provision
 - Measure voltage on D+ (D+, JP1) to be 0.6 V
 - Open the software
 - Click **Read** in the software and **Status** for **D+/D– Detection** should read *SDP Detected or EN2=1, EN1=0*
 - Set in the **Input Current Limit** to 500 mA
 - Check **Clear VD+ Source** box and uncheck it
 - Measure voltage on D+ (D+, JP2) to 0 V
 - Now you are exited the dead battery provision

6 Test Results

6.1 Output Regulation Ripple

The test results shown in Figure 6 and Figure 7 are taken under 6-V input, 3.8-V battery and heavy and light charging currents.

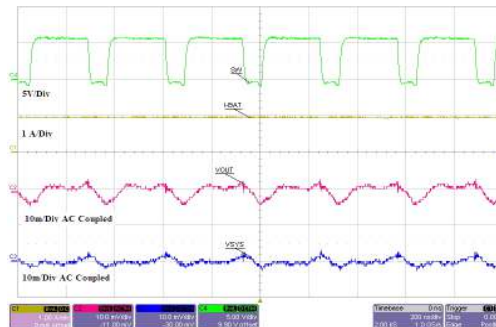

Figure 6. Output Regulation Ripple at ICHG = 1000 mA

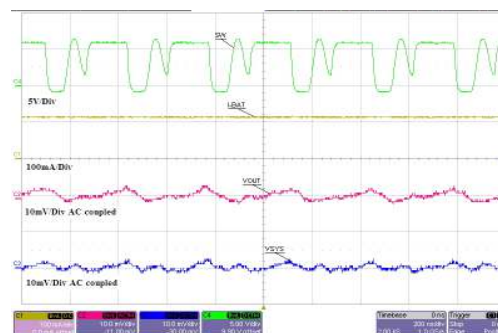

Figure 7. Output Regulation Ripple at ICHG = 120 mA

6.2 Efficiency Data

Figure 8 illustrates the efficiency when the device is regulating the battery voltage (constant voltage charge region). Here the charge current was set to 2 A and the BAT pin was loaded with an electronic load. Different V_{IN} levels were captured to compare the performance of the SMPS over increasing input voltages.

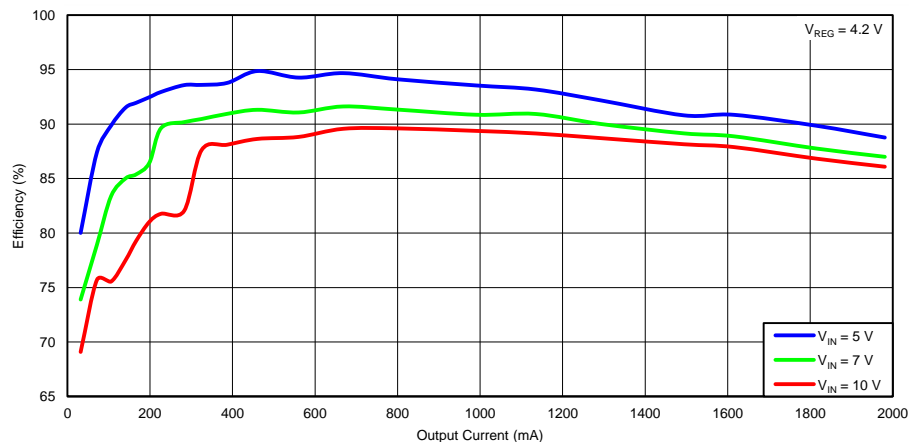

Figure 8. Efficiency Versus Output Current While in Battery Voltage Regulation (4.2V)

6.3 Thermal Performance

This section shows a thermal image of the bq24257 running at 6-V input and 1-A system load, a 3.8-V battery is used and charging at rate 1000 mA. There is no air flow and the ambient temperature is 25°C. The peak temperature of the IC (60.4°C) is well below the maximum recommended operating condition listed in the data sheet.



Figure 9. Thermal Image

7 Layout and Bill of Materials

7.1 Printed-Circuit Board Layout Guideline

1. Place the BOOT, PMID, IN, BAT, and LDO capacitors as close as possible to the IC for optimal performance.
2. Connect the inductor as close as possible to the SW pin, and the CSIN cap as close as possible to the inductor minimizing noise in the path.
3. Place a 1- μ F PMID capacitor as close as possible to the PMID and PGND pins, making the high-frequency current loop area as small as possible.
4. The local bypass capacitor from SYS/CSIN to GND must be connected between the SYS/CSIN pin and PGND of the IC. This minimizes the current path loop area from the SW pin through the LC filter and back to the PGND pin.
5. Place all decoupling capacitors close to their respective IC pins and as close as possible to PGND (do not place components such that routing interrupts power-stage currents). All small control signals must be routed away from the high-current paths.
6. To reduce noise coupling, use a ground plane, if possible, to isolate the noisy traces from spreading its noise all over the board. Put vias inside the PGND pads for the IC.
7. The high-current charge paths into IN, Micro-USB, BAT, SYS/CSIN, and from the SW pins must be sized appropriately for the maximum charge current to avoid voltage drops in these traces.
8. For high-current applications, the balls for the power paths must be connected to as much copper in the board as possible. This allows better thermal performance because the board conducts heat away from the IC.

7.2 Layout

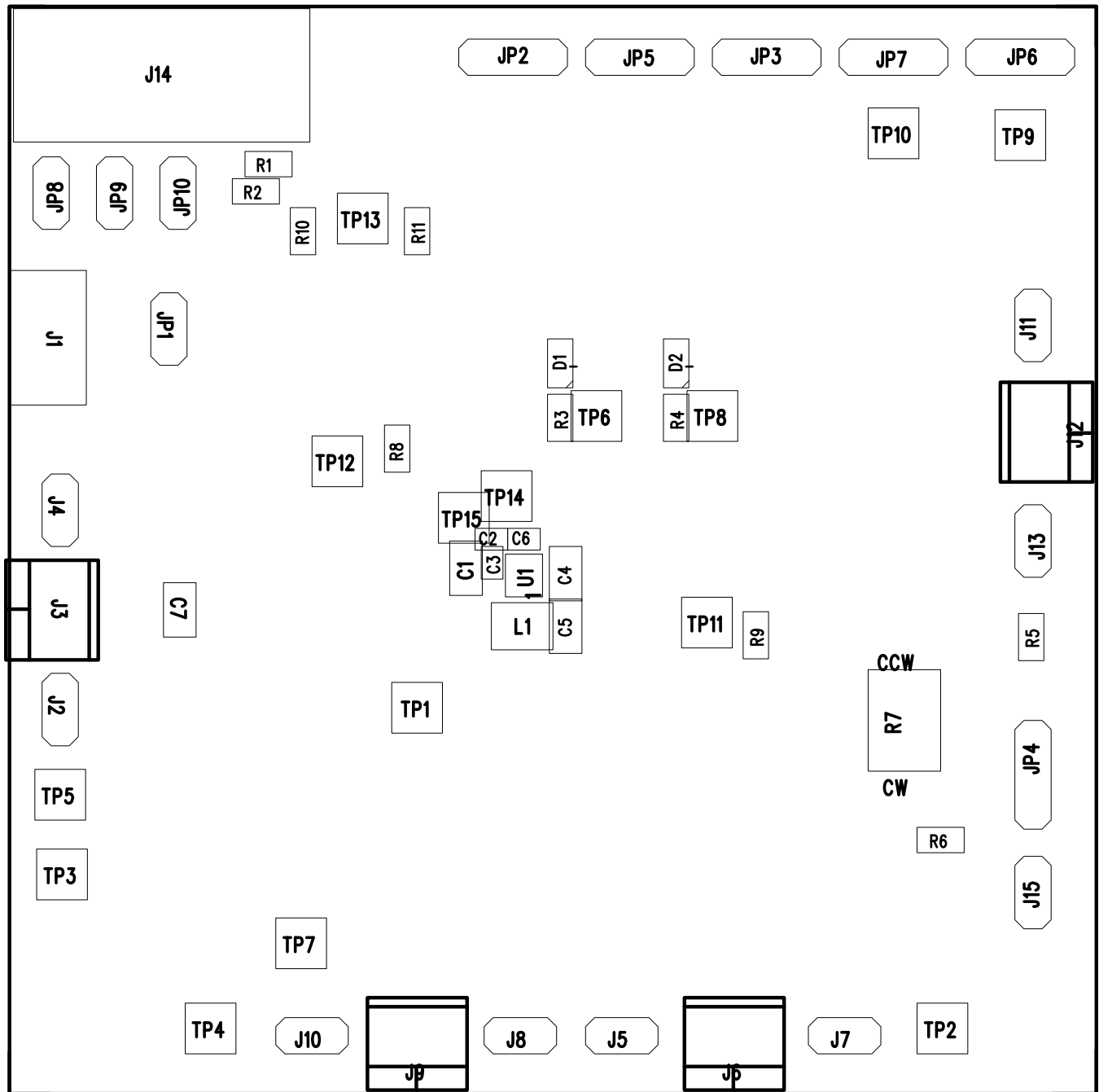

Figure 10. bq2425xEVM-150 Top Assembly

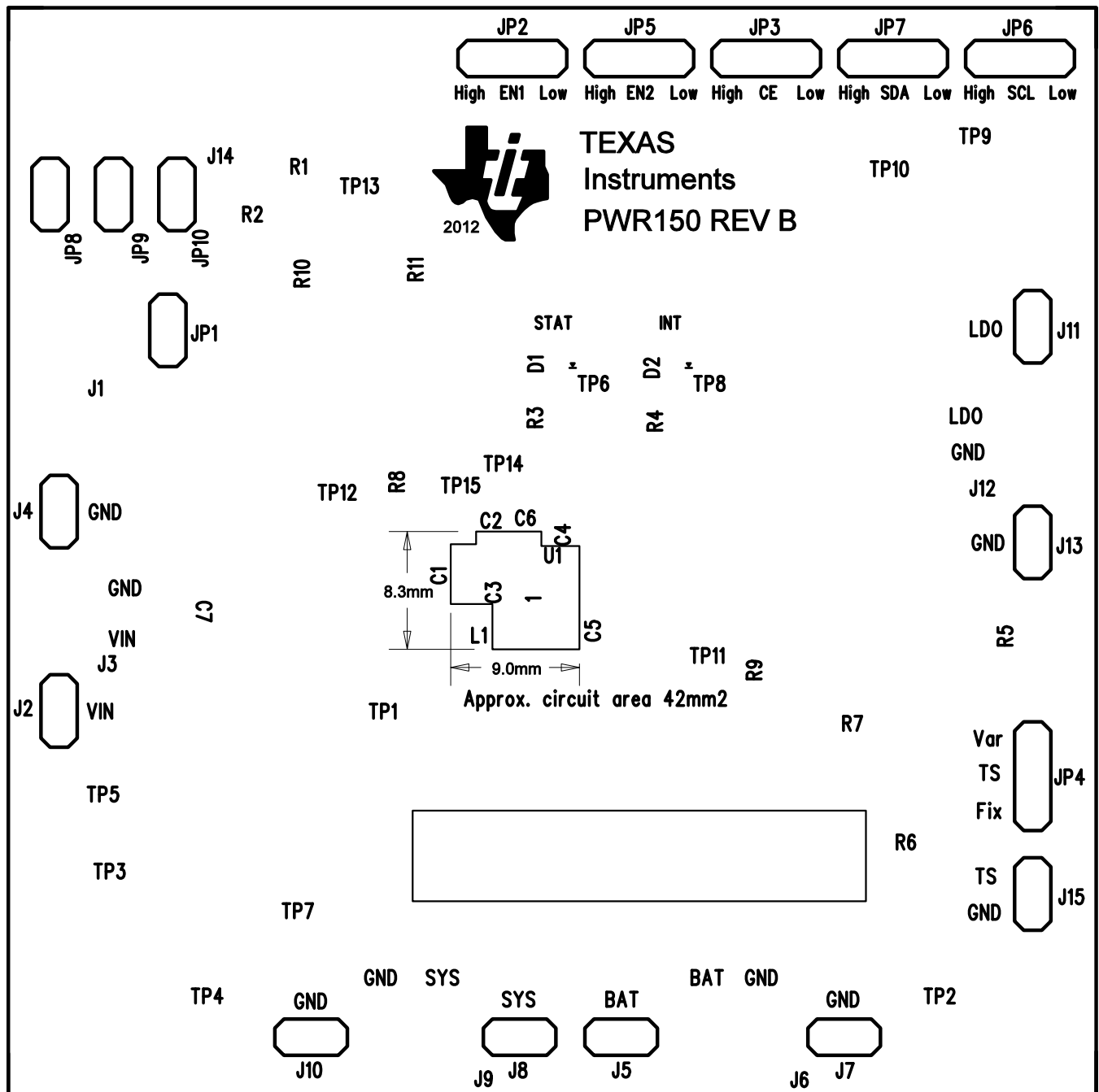

Figure 11. bq2425xEVM-150 Top Silkscreen

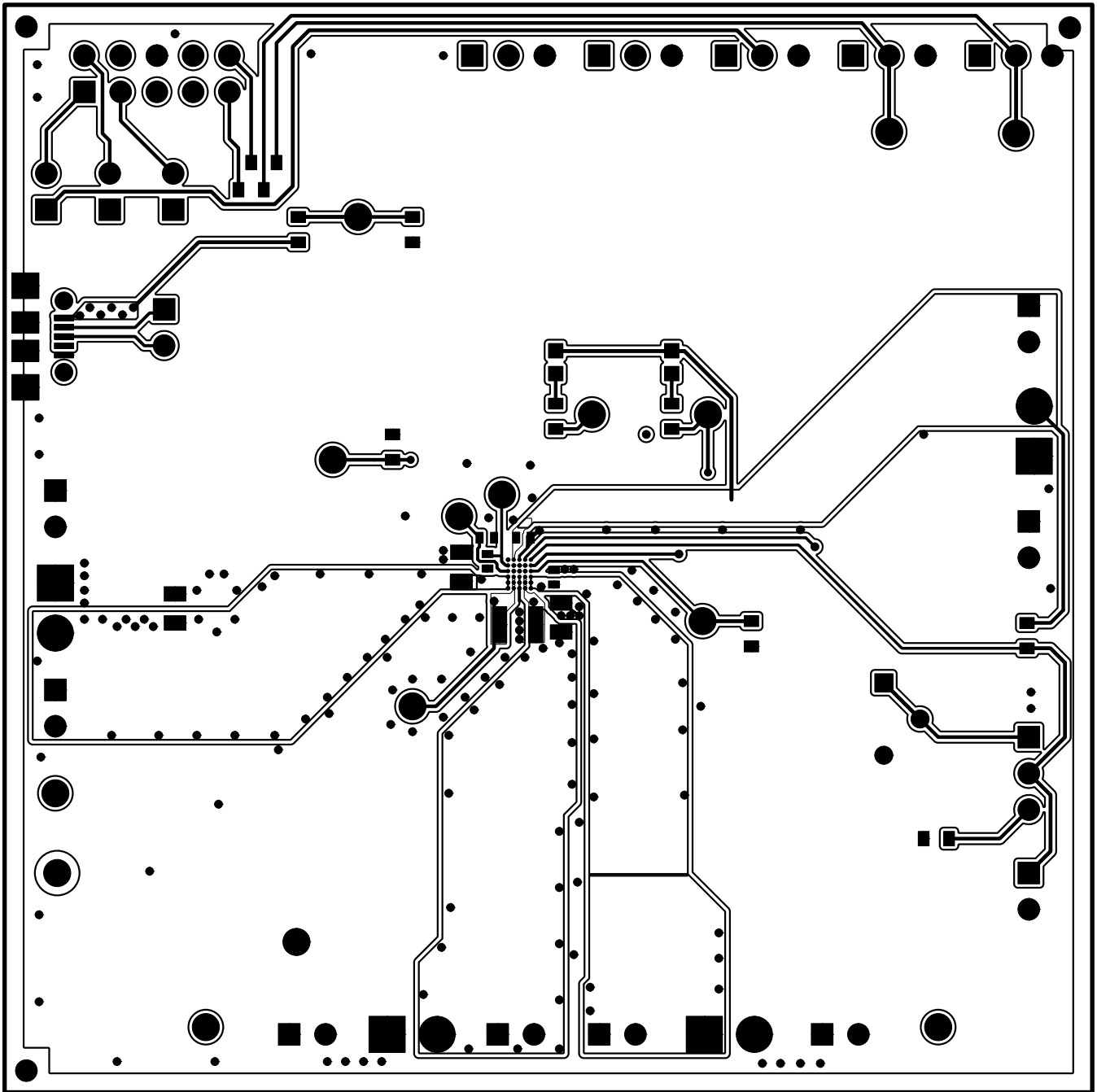

Figure 12. bq2425xEVM-150 Top Layer

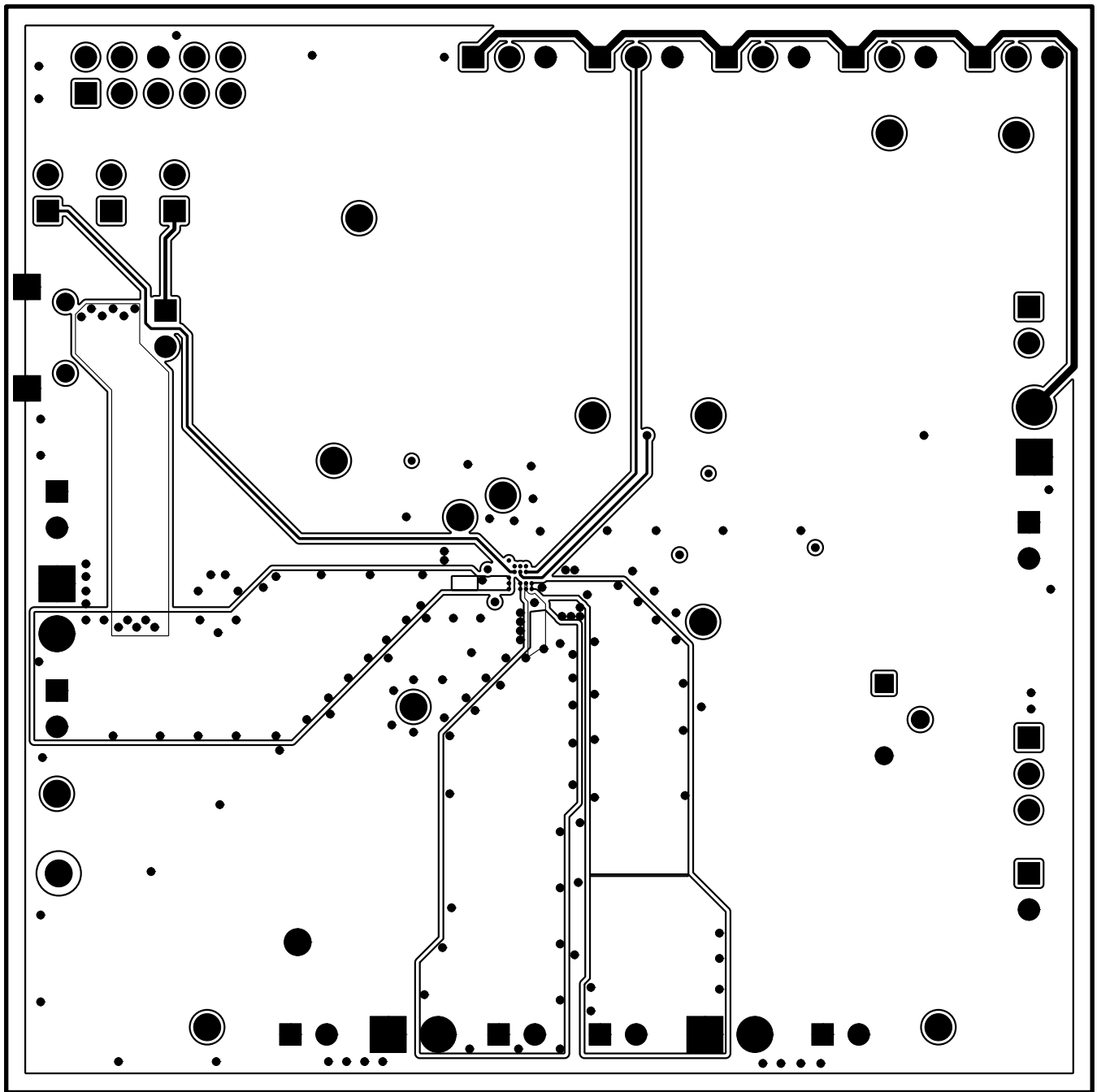

Figure 13. bq2425xEVM-150 Second Layer (Internal) Routine

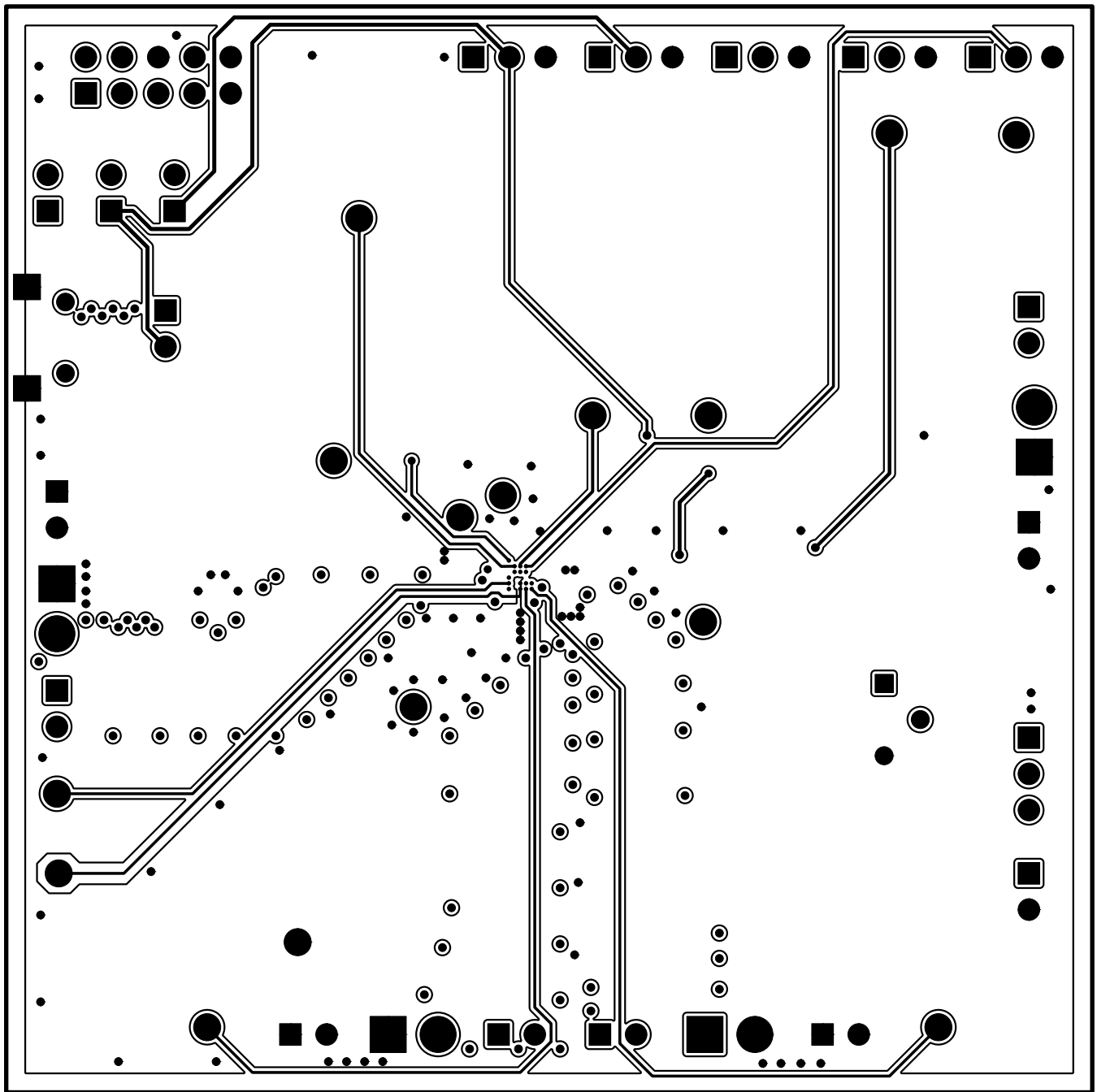

Figure 14. bq2425xEVM-150 Third Layer (Internal) Routine

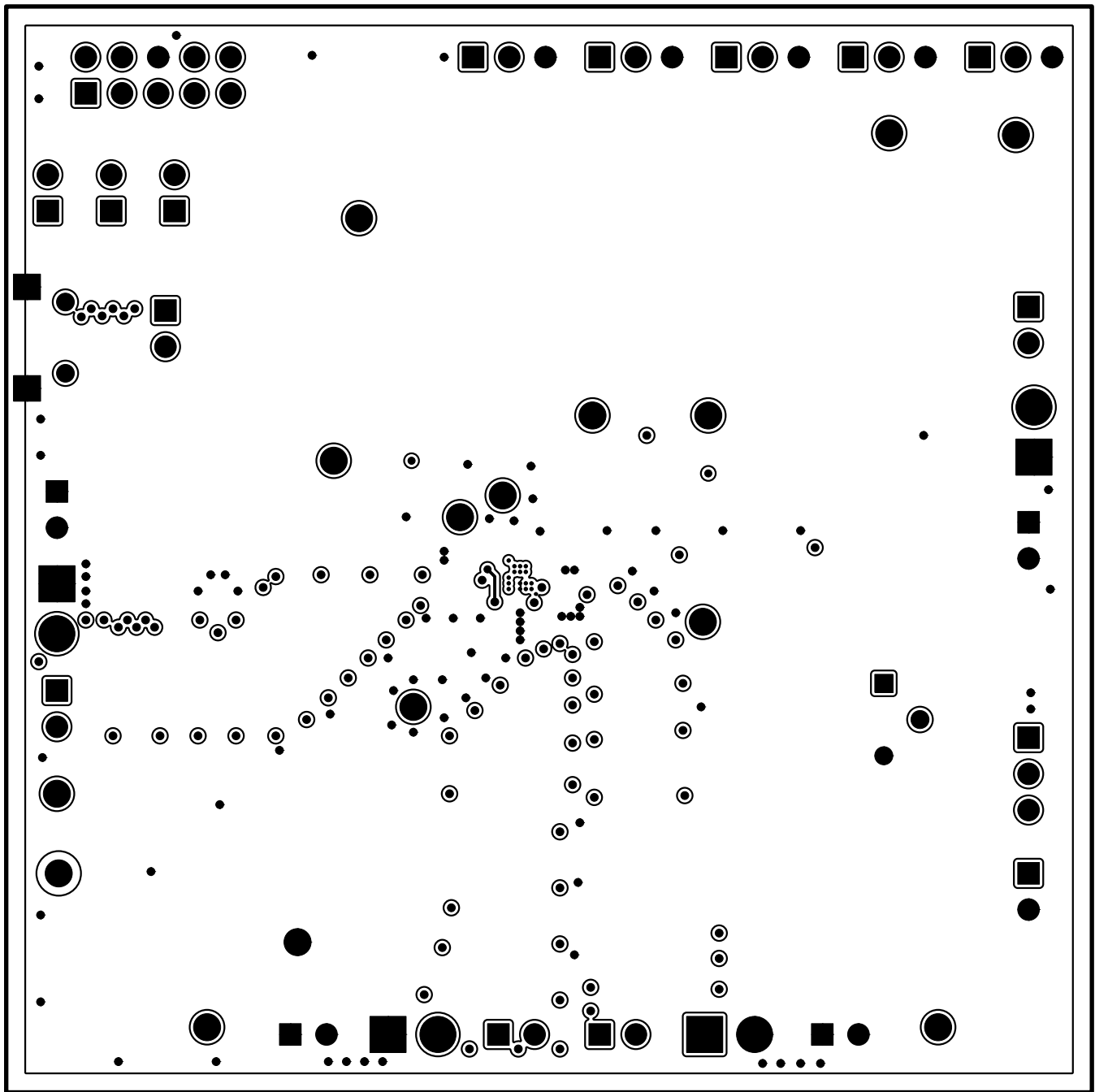

Figure 15. bq2425xEVM-150 Bottom Layer

7.3 Bill of Materials (BOM)

Table 5. bq2425xEVM-150 Bill of Materials

COUNT			RefDes	Value	Description	Size	Part Number	MFR
001	002	003						
2	2	2	C1, C7	1.0uF	Capacitor, Ceramic, 25V, X5R, 20%	0805	STD	STD
1	1	1	C2	1.0uF	Capacitor, Ceramic, 16V, X5R, 10%	0402	STD	STD
1	1	1	C3	0.033uF	Capacitor, Ceramic, 25V, X5R, 10%	0402	STD	STD
1	1	1	C6	1.0uF	Capacitor, Ceramic, 6.3V, X5R, 10%	0402	STD	STD
1	1	0	C5	22uF	Capacitor, Ceramic, 10V, X5R, 20%	0805	STD	STD
0	0	1	C5	1.0uF	Capacitor, Ceramic, 10V, X5R, 20%	0805	STD	STD
1	1	0	C4	1.0uF	Capacitor, Ceramic, 10V, X5R, 20%	0805	STD	STD
0	0	1	C4	22uF	Capacitor, Ceramic, 10V, X5R, 20%	0805	STD	STD
2	2	2	D1-2	LTST-C190GKT	Diode, LED, Green, 2.1-V, 20-mA, 6-mcd	0603	LTST-C190GKT	Lite On
1	1	1	J1	1050170001	Connector, SMT, Micro USB-B	5x7.5 mm	1050170001	Molex
1	1	1	J14	N2510-6002RB	Connector, Male Straight 2x5 pin, 100mil spacing, 4 Wall	0.338 x 0.788 inch	N2510-6002RB	3M
9	9	9	J2 J4-5 J7-8 J10-11 J13 J15	PEC02SAAN	Header, Male 2-pin, 100mil spacing,	0.100 inch x 2	PEC02SAAN	Sullins
4	4	4	J3 J6 J9 J12	ED555/2DS	Terminal Block, 2-pin, 6-A, 3.5mm	0.27 x 0.25 inch	ED555/2DS	OST
4	4	4	JP1 JP8-10	PEC02SAAN	Header, Male 2-pin, 100mil spacing,	0.100 inch x 2	PEC02SAAN	Sullins
4	4	4	JP3, 4, 6, 7	PEC03SAAN	Header, Male 3-pin, 100mil spacing,	0.100 inch x 3	PEC03SAAN	Sullins
1	1	1	L1	1.0uH	Inductor, SMT ±30%	2x2.5 mm	1239AS-H-1R0M (DFE252012C) see Note 8	Toko
1	1	1	R10	274K	Resistor, Chip, 1/16W, 1%	0603	STD	STD
1	1	1	R11	100K	Resistor, Chip, 1/16W, 1%	0603	STD	STD
2	2	2	R1-2	200	Resistor, Chip, 1/16W, 1%	0603	STD	STD
2	2	2	R3-4	1.50K	Resistor, Chip, 1/16W, 1%	0603	STD	STD
2	2	2	R5-6	20.0K	Resistor, Chip, 1/16W, 1%	0603	STD	STD
1	1	1	R7	100K	Potentiometer, 3/8 Cermet, Twelve-Turn	0.25x0.17 inch	3266W-1-104LF	Bourns
1	1	1	R8	267	Resistor, Chip, 1/16W, 1%	0603	STD	STD
1	1	1	R9	249	Resistor, Chip, 1/16W, 1%	0603	STD	STD
15	15	15	TP1-15	5002	Test Point, White, Thru Hole Color Keyed	0.100 x 0.100 inch	5002	Keystone
1	0	0	U1	BQ24250YFF	IC, 2.0A Single Input I2C/Standalone Switch-Mode Li-Ion Battery Charger	BGA	BQ24250YFF	TI
0	1	0	U1	BQ24251YFF	IC, 2.0A Single Input I2C/Standalone Switch-Mode Li-Ion Battery Charger	BGA	BQ24251YFF	TI
0	0	1	U1	BQ24257YFF	IC, 2.0A Single Input I2C/Standalone Switch-Mode Li-Ion Battery Charger	BGA	BQ24257YFF	TI
0	0	0	JP2, 5	Open	Header, Male 3-pin, 100mil spacing,	0.100 inch x 3	PEC03SAAN	Sullins
5	3	3	--	--	Shunt, 100-mil, Black	0.100	929950-00	3M
1	1	1	--	--	PCB		PWR150	Any

- Notes:**
1. These assemblies are ESD sensitive, observe ESD precautions.
 2. These assemblies must be clean and free from flux and all contaminants. Use of no-clean flux is not acceptable.
 3. These assemblies must comply with workmanship standards IPC-A-610 Class 2.
 4. The ICs of the first build of these EVMs have a different marker.
 5. Ref designators marked with an asterisk (***) cannot be substituted. All other components can be substituted with equivalent MFG's components.
 6. Install shunts on:
 - JP3 between CE and LOW (all)
 - JP4 between TS and FIX (all)
 - JP8 Install (all)
 - JP5 between D-/EN2 and Low (bq24250 only)
 - JP2 between D+/EN1 and Low (bq24250 only)
 7. The first cycle of this EVM, the Top Marking of the IC is different from the latter cycles.
 8. TFM252010A-1ROM from TDK inductor can be used.

EVALUATION BOARD/KIT/MODULE (EVM) ADDITIONAL TERMS

Texas Instruments (TI) provides the enclosed Evaluation Board/Kit/Module (EVM) under the following conditions:

The user assumes all responsibility and liability for proper and safe handling of the goods. Further, the user indemnifies TI from all claims arising from the handling or use of the goods.

Should this evaluation board/kit not meet the specifications indicated in the User's Guide, the board/kit may be returned within 30 days from the date of delivery for a full refund. THE FOREGOING LIMITED WARRANTY IS THE EXCLUSIVE WARRANTY MADE BY SELLER TO BUYER AND IS IN LIEU OF ALL OTHER WARRANTIES, EXPRESSED, IMPLIED, OR STATUTORY, INCLUDING ANY WARRANTY OF MERCHANTABILITY OR FITNESS FOR ANY PARTICULAR PURPOSE. EXCEPT TO THE EXTENT OF THE INDEMNITY SET FORTH ABOVE, NEITHER PARTY SHALL BE LIABLE TO THE OTHER FOR ANY INDIRECT, SPECIAL, INCIDENTAL, OR CONSEQUENTIAL DAMAGES.

Please read the User's Guide and, specifically, the Warnings and Restrictions notice in the User's Guide prior to handling the product. This notice contains important safety information about temperatures and voltages. For additional information on TI's environmental and/or safety programs, please visit www.ti.com/esh or contact TI.

No license is granted under any patent right or other intellectual property right of TI covering or relating to any machine, process, or combination in which such TI products or services might be or are used. TI currently deals with a variety of customers for products, and therefore our arrangement with the user is not exclusive. TI assumes no liability for applications assistance, customer product design, software performance, or infringement of patents or services described herein.

REGULATORY COMPLIANCE INFORMATION

As noted in the EVM User's Guide and/or EVM itself, this EVM and/or accompanying hardware may or may not be subject to the Federal Communications Commission (FCC) and Industry Canada (IC) rules.

For EVMs **not** subject to the above rules, this evaluation board/kit/module is intended for use for ENGINEERING DEVELOPMENT, DEMONSTRATION OR EVALUATION PURPOSES ONLY and is not considered by TI to be a finished end product fit for general consumer use. It generates, uses, and can radiate radio frequency energy and has not been tested for compliance with the limits of computing devices pursuant to part 15 of FCC or ICES-003 rules, which are designed to provide reasonable protection against radio frequency interference. Operation of the equipment may cause interference with radio communications, in which case the user at his own expense will be required to take whatever measures may be required to correct this interference.

General Statement for EVMs including a radio

User Power/Frequency Use Obligations: This radio is intended for development/professional use only in legally allocated frequency and power limits. Any use of radio frequencies and/or power availability of this EVM and its development application(s) must comply with local laws governing radio spectrum allocation and power limits for this evaluation module. It is the user's sole responsibility to only operate this radio in legally acceptable frequency space and within legally mandated power limitations. Any exceptions to this are strictly prohibited and unauthorized by Texas Instruments unless user has obtained appropriate experimental/development licenses from local regulatory authorities, which is responsibility of user including its acceptable authorization.

For EVMs annotated as FCC – FEDERAL COMMUNICATIONS COMMISSION Part 15 Compliant

Caution

This device complies with part 15 of the FCC Rules. Operation is subject to the following two conditions: (1) This device may not cause harmful interference, and (2) this device must accept any interference received, including interference that may cause undesired operation.

Changes or modifications not expressly approved by the party responsible for compliance could void the user's authority to operate the equipment.

FCC Interference Statement for Class A EVM devices

This equipment has been tested and found to comply with the limits for a Class A digital device, pursuant to part 15 of the FCC Rules. These limits are designed to provide reasonable protection against harmful interference when the equipment is operated in a commercial environment. This equipment generates, uses, and can radiate radio frequency energy and, if not installed and used in accordance with the instruction manual, may cause harmful interference to radio communications. Operation of this equipment in a residential area is likely to cause harmful interference in which case the user will be required to correct the interference at his own expense.

FCC Interference Statement for Class B EVM devices

This equipment has been tested and found to comply with the limits for a Class B digital device, pursuant to part 15 of the FCC Rules. These limits are designed to provide reasonable protection against harmful interference in a residential installation. This equipment generates, uses and can radiate radio frequency energy and, if not installed and used in accordance with the instructions, may cause harmful interference to radio communications. However, there is no guarantee that interference will not occur in a particular installation. If this equipment does cause harmful interference to radio or television reception, which can be determined by turning the equipment off and on, the user is encouraged to try to correct the interference by one or more of the following measures:

- Reorient or relocate the receiving antenna.
- Increase the separation between the equipment and receiver.
- Connect the equipment into an outlet on a circuit different from that to which the receiver is connected.
- Consult the dealer or an experienced radio/TV technician for help.

For EVMs annotated as IC – INDUSTRY CANADA Compliant

This Class A or B digital apparatus complies with Canadian ICES-003.

Changes or modifications not expressly approved by the party responsible for compliance could void the user's authority to operate the equipment.

Concerning EVMs including radio transmitters

This device complies with Industry Canada licence-exempt RSS standard(s). Operation is subject to the following two conditions: (1) this device may not cause interference, and (2) this device must accept any interference, including interference that may cause undesired operation of the device.

Concerning EVMs including detachable antennas

Under Industry Canada regulations, this radio transmitter may only operate using an antenna of a type and maximum (or lesser) gain approved for the transmitter by Industry Canada. To reduce potential radio interference to other users, the antenna type and its gain should be so chosen that the equivalent isotropically radiated power (e.i.r.p.) is not more than that necessary for successful communication.

This radio transmitter has been approved by Industry Canada to operate with the antenna types listed in the user guide with the maximum permissible gain and required antenna impedance for each antenna type indicated. Antenna types not included in this list, having a gain greater than the maximum gain indicated for that type, are strictly prohibited for use with this device.

Cet appareil numérique de la classe A ou B est conforme à la norme NMB-003 du Canada.

Les changements ou les modifications pas expressément approuvés par la partie responsable de la conformité ont pu vider l'autorité de l'utilisateur pour actionner l'équipement.

Concernant les EVMs avec appareils radio

Le présent appareil est conforme aux CNR d'Industrie Canada applicables aux appareils radio exempts de licence. L'exploitation est autorisée aux deux conditions suivantes : (1) l'appareil ne doit pas produire de brouillage, et (2) l'utilisateur de l'appareil doit accepter tout brouillage radioélectrique subi, même si le brouillage est susceptible d'en compromettre le fonctionnement.

Concernant les EVMs avec antennes détachables

Conformément à la réglementation d'Industrie Canada, le présent émetteur radio peut fonctionner avec une antenne d'un type et d'un gain maximal (ou inférieur) approuvé pour l'émetteur par Industrie Canada. Dans le but de réduire les risques de brouillage radioélectrique à l'intention des autres utilisateurs, il faut choisir le type d'antenne et son gain de sorte que la puissance isotrope rayonnée équivalente (p.i.r.e.) ne dépasse pas l'intensité nécessaire à l'établissement d'une communication satisfaisante.

Le présent émetteur radio a été approuvé par Industrie Canada pour fonctionner avec les types d'antenne énumérés dans le manuel d'usage et ayant un gain admissible maximal et l'impédance requise pour chaque type d'antenne. Les types d'antenne non inclus dans cette liste, ou dont le gain est supérieur au gain maximal indiqué, sont strictement interdits pour l'exploitation de l'émetteur.

【Important Notice for Users of this Product in Japan】

This development kit is NOT certified as Confirming to Technical Regulations of Radio Law of Japan

If you use this product in Japan, you are required by Radio Law of Japan to follow the instructions below with respect to this product:

1. Use this product in a shielded room or any other test facility as defined in the notification #173 issued by Ministry of Internal Affairs and Communications on March 28, 2006, based on Sub-section 1.1 of Article 6 of the Ministry's Rule for Enforcement of Radio Law of Japan,
2. Use this product only after you obtained the license of Test Radio Station as provided in Radio Law of Japan with respect to this product, or
3. Use of this product only after you obtained the Technical Regulations Conformity Certification as provided in Radio Law of Japan with respect to this product. Also, please do not transfer this product, unless you give the same notice above to the transferee. Please note that if you could not follow the instructions above, you will be subject to penalties of Radio Law of Japan.

Texas Instruments Japan Limited
(address) 24-1, Nishi-Shinjuku 6 chome, Shinjuku-ku, Tokyo, Japan

<http://www.tij.co.jp>

【ご使用にあたっての注】

本開発キットは技術基準適合証明を受けておりません。

本製品のご使用に際しては、電波法遵守のため、以下のいずれかの措置を取っていただく必要がありますのでご注意ください。

1. 電波法施行規則第6条第1項第1号に基づく平成18年3月28日総務省告示第173号で定められた電波暗室等の試験設備でご使用いただく。
2. 実験局の免許を取得後ご使用いただく。
3. 技術基準適合証明を取得後ご使用いただく。

なお、本製品は、上記の「ご使用にあたっての注意」を譲渡先、移転先に通知しない限り、譲渡、移転できないものとします。

上記を遵守頂けない場合は、電波法の罰則が適用される可能性があることをご留意ください。

日本テキサス・インスツルメンツ株式会社
東京都新宿区西新宿6丁目24番1号
西新宿三井ビル

<http://www.tij.co.jp>

EVALUATION BOARD/KIT/MODULE (EVM) WARNINGS, RESTRICTIONS AND DISCLAIMERS

For Feasibility Evaluation Only, in Laboratory/Development Environments. Unless otherwise indicated, this EVM is not a finished electrical equipment and not intended for consumer use. It is intended solely for use for preliminary feasibility evaluation in laboratory/development environments by technically qualified electronics experts who are familiar with the dangers and application risks associated with handling electrical mechanical components, systems and subsystems. It should not be used as all or part of a finished end product.

Your Sole Responsibility and Risk. You acknowledge, represent and agree that:

1. You have unique knowledge concerning Federal, State and local regulatory requirements (including but not limited to Food and Drug Administration regulations, if applicable) which relate to your products and which relate to your use (and/or that of your employees, affiliates, contractors or designees) of the EVM for evaluation, testing and other purposes.
2. You have full and exclusive responsibility to assure the safety and compliance of your products with all such laws and other applicable regulatory requirements, and also to assure the safety of any activities to be conducted by you and/or your employees, affiliates, contractors or designees, using the EVM. Further, you are responsible to assure that any interfaces (electronic and/or mechanical) between the EVM and any human body are designed with suitable isolation and means to safely limit accessible leakage currents to minimize the risk of electrical shock hazard.
3. You will employ reasonable safeguards to ensure that your use of the EVM will not result in any property damage, injury or death, even if the EVM should fail to perform as described or expected.
4. You will take care of proper disposal and recycling of the EVM's electronic components and packing materials.

Certain Instructions. It is important to operate this EVM within TI's recommended specifications and environmental considerations per the user guidelines. Exceeding the specified EVM ratings (including but not limited to input and output voltage, current, power, and environmental ranges) may cause property damage, personal injury or death. If there are questions concerning these ratings please contact a TI field representative prior to connecting interface electronics including input power and intended loads. Any loads applied outside of the specified output range may result in unintended and/or inaccurate operation and/or possible permanent damage to the EVM and/or interface electronics. Please consult the EVM User's Guide prior to connecting any load to the EVM output. If there is uncertainty as to the load specification, please contact a TI field representative. During normal operation, some circuit components may have case temperatures greater than 60°C as long as the input and output are maintained at a normal ambient operating temperature. These components include but are not limited to linear regulators, switching transistors, pass transistors, and current sense resistors which can be identified using the EVM schematic located in the EVM User's Guide. When placing measurement probes near these devices during normal operation, please be aware that these devices may be very warm to the touch. As with all electronic evaluation tools, only qualified personnel knowledgeable in electronic measurement and diagnostics normally found in development environments should use these EVMs.

Agreement to Defend, Indemnify and Hold Harmless. You agree to defend, indemnify and hold TI, its licensors and their representatives harmless from and against any and all claims, damages, losses, expenses, costs and liabilities (collectively, "Claims") arising out of or in connection with any use of the EVM that is not in accordance with the terms of the agreement. This obligation shall apply whether Claims arise under law of tort or contract or any other legal theory, and even if the EVM fails to perform as described or expected.

Safety-Critical or Life-Critical Applications. If you intend to evaluate the components for possible use in safety critical applications (such as life support) where a failure of the TI product would reasonably be expected to cause severe personal injury or death, such as devices which are classified as FDA Class III or similar classification, then you must specifically notify TI of such intent and enter into a separate Assurance and Indemnity Agreement.

Mailing Address: Texas Instruments, Post Office Box 655303, Dallas, Texas 75265
Copyright © 2012, Texas Instruments Incorporated

IMPORTANT NOTICE

Texas Instruments Incorporated and its subsidiaries (TI) reserve the right to make corrections, enhancements, improvements and other changes to its semiconductor products and services per JESD46, latest issue, and to discontinue any product or service per JESD48, latest issue. Buyers should obtain the latest relevant information before placing orders and should verify that such information is current and complete. All semiconductor products (also referred to herein as "components") are sold subject to TI's terms and conditions of sale supplied at the time of order acknowledgment.

TI warrants performance of its components to the specifications applicable at the time of sale, in accordance with the warranty in TI's terms and conditions of sale of semiconductor products. Testing and other quality control techniques are used to the extent TI deems necessary to support this warranty. Except where mandated by applicable law, testing of all parameters of each component is not necessarily performed.

TI assumes no liability for applications assistance or the design of Buyers' products. Buyers are responsible for their products and applications using TI components. To minimize the risks associated with Buyers' products and applications, Buyers should provide adequate design and operating safeguards.

TI does not warrant or represent that any license, either express or implied, is granted under any patent right, copyright, mask work right, or other intellectual property right relating to any combination, machine, or process in which TI components or services are used. Information published by TI regarding third-party products or services does not constitute a license to use such products or services or a warranty or endorsement thereof. Use of such information may require a license from a third party under the patents or other intellectual property of the third party, or a license from TI under the patents or other intellectual property of TI.

Reproduction of significant portions of TI information in TI data books or data sheets is permissible only if reproduction is without alteration and is accompanied by all associated warranties, conditions, limitations, and notices. TI is not responsible or liable for such altered documentation. Information of third parties may be subject to additional restrictions.

Resale of TI components or services with statements different from or beyond the parameters stated by TI for that component or service voids all express and any implied warranties for the associated TI component or service and is an unfair and deceptive business practice. TI is not responsible or liable for any such statements.

Buyer acknowledges and agrees that it is solely responsible for compliance with all legal, regulatory and safety-related requirements concerning its products, and any use of TI components in its applications, notwithstanding any applications-related information or support that may be provided by TI. Buyer represents and agrees that it has all the necessary expertise to create and implement safeguards which anticipate dangerous consequences of failures, monitor failures and their consequences, lessen the likelihood of failures that might cause harm and take appropriate remedial actions. Buyer will fully indemnify TI and its representatives against any damages arising out of the use of any TI components in safety-critical applications.

In some cases, TI components may be promoted specifically to facilitate safety-related applications. With such components, TI's goal is to help enable customers to design and create their own end-product solutions that meet applicable functional safety standards and requirements. Nonetheless, such components are subject to these terms.

No TI components are authorized for use in FDA Class III (or similar life-critical medical equipment) unless authorized officers of the parties have executed a special agreement specifically governing such use.

Only those TI components which TI has specifically designated as military grade or "enhanced plastic" are designed and intended for use in military/aerospace applications or environments. Buyer acknowledges and agrees that any military or aerospace use of TI components which have **not** been so designated is solely at the Buyer's risk, and that Buyer is solely responsible for compliance with all legal and regulatory requirements in connection with such use.

TI has specifically designated certain components as meeting ISO/TS16949 requirements, mainly for automotive use. In any case of use of non-designated products, TI will not be responsible for any failure to meet ISO/TS16949.

Products

Audio	www.ti.com/audio
Amplifiers	amplifier.ti.com
Data Converters	dataconverter.ti.com
DLP® Products	www.dlp.com
DSP	dsp.ti.com
Clocks and Timers	www.ti.com/clocks
Interface	interface.ti.com
Logic	logic.ti.com
Power Mgmt	power.ti.com
Microcontrollers	microcontroller.ti.com
RFID	www.ti-rfid.com
OMAP Applications Processors	www.ti.com/omap
Wireless Connectivity	www.ti.com/wirelessconnectivity

Applications

Automotive and Transportation	www.ti.com/automotive
Communications and Telecom	www.ti.com/communications
Computers and Peripherals	www.ti.com/computers
Consumer Electronics	www.ti.com/consumer-apps
Energy and Lighting	www.ti.com/energy
Industrial	www.ti.com/industrial
Medical	www.ti.com/medical
Security	www.ti.com/security
Space, Avionics and Defense	www.ti.com/space-avionics-defense
Video and Imaging	www.ti.com/video

TI E2E Community

e2e.ti.com