

Inside Diameter Measurement Bore Gage

Bulletin No. 2005



Best-selling range of bore gages now offers better accuracy,
user-friendliness and durability

Mitutoyo

Bore Gage

NEW

The Best-Selling Inside Diameter Measurement Tools are now

**More Accurate,
More Easily Used,
More Durable!**



Standard bore gage

Bore gage with micrometer head

1 All models now more accurate

The measurement accuracy of new models has improved by 50% or more compared with their predecessors (in JIS standard values).

Wide-range accuracy:
Improved from 5 μm to 2 μm
Repeatability: Improved from 2 μm to 0.5 μm
Adjacent error: Improved from 2 μm to 1 μm



2 33% longer plunger stroke

The plunger stroke of flagship models has expanded from 1.2mm to 1.6mm, still maintaining the stated accuracy. (For information about compatible models, refer to the specification of each model on pages 4 and 6.)

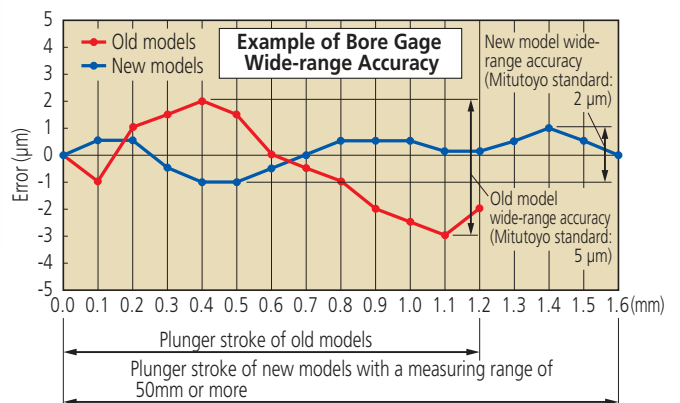
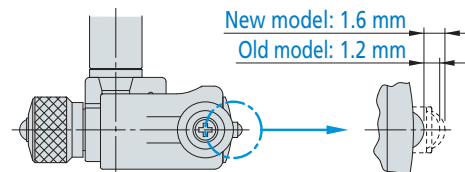

Mitutoyo

Nakatsugawa Plant Dedicated to the Manufacture of Sensors

The Nakatsugawa Plant was established in 1997 as the twelfth Mitutoyo plant in Japan and is located in a beautiful natural environment within the central industrial complex of Nakatsugawa City, Gifu Prefecture. It is dedicated to sensor manufacture and incorporates an integrated production system from design to manufacture of measuring instruments such as dial gages, test indicators, digimatic indicators and bore gages. Leading-edge production technologies and facilities ensure that the Mitutoyo-brand instruments shipped from here are highly valued as the world's best, providing users with a strong feeling of confidence.



3 Carbide contact-tips and anvils

The new carbide-ball contact point and anvil tip have increased abrasion resistance compared with the steel-ball type and better surface roughness compared with the molded carbide-tip type. Thus, they almost never scratch a workpiece.

Improved abrasion resistance over a steel-ball type



Test method

- Rotating a sandpaper-wrapped cylinder against the ball tip.

Sandpaper: 9 μm grit size
Load: 0.5N (50g)
Sliding distance: 1,000m



Much less damage to soft materials

Old carbide tip (molded part)

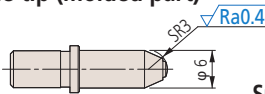

Surface profile of specimen after test

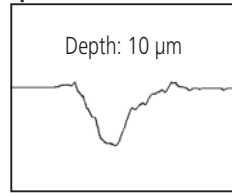

New type carbide ball-tip

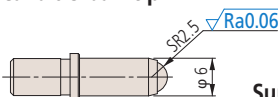

Surface profile of specimen after test

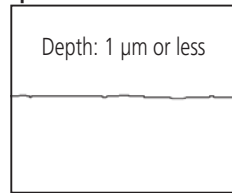
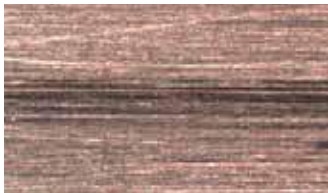

Test method

- Reciprocating the tip 20 times on an aluminum plate under a load of 4N

4 New grip improves accuracy during prolonged use

(Design registered in Japan)

This model reduces the influence of heat from the operator's hand by 50% by increasing the grip size and making the grip hollow-structured, thereby retaining high-accuracy measurement.



The length below the grip is the same as that of the old model. This guarantees no difference in operability of the gage.

(Note: The overall length of this model is longer than that of its predecessor and therefore may not fit in an existing custom-made storage box.)

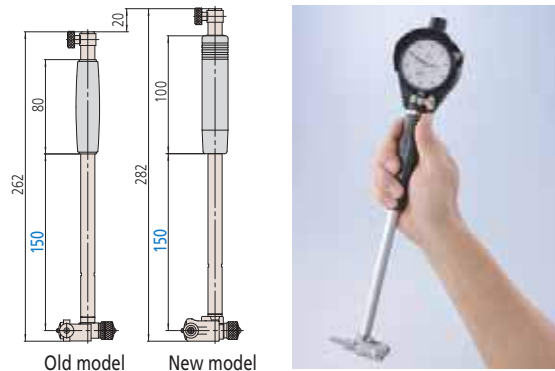

5 New contacts mean smoother action and better durability



Comparison of measuring force between the new and old models (50-to-150mm models)

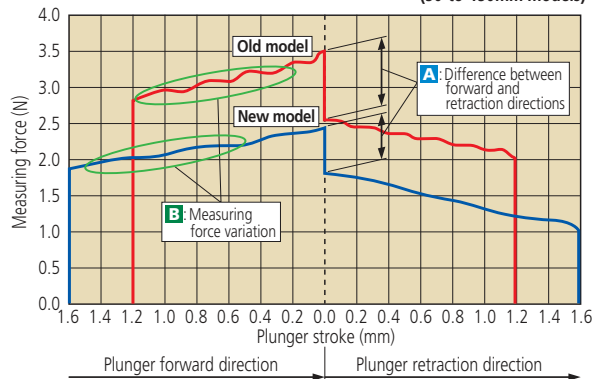

- A:** The new models provide a minimum difference in measuring force between the forward and retraction directions, thus achieving smooth operation and high durability.
- B:** The new models enable stable measurement by reducing the variation of measuring force.

Series 511 Standard Bore Gage

Accuracy

- Wide-range accuracy: $2\ \mu\text{m}$ / .00008"
- Repeatability: $0.5\ \mu\text{m}$ / .00002"
- Adjacent error: $1\ \mu\text{m}$ / .00004"

Standard Bore Gage



511-743



511-703

Measuring Heads



Specifications

• Inch Gage Stem ϕ 3/8"

Measuring Range	Order No. Without Indicator	Order No. With 2922SB Graduation .0005"	Order No. With 2923SB-10 Graduation .0001"	Number of Anvils	Number of Spacers
.7 - 1.4"	511-731	511-741	511-751	9	2
1.4 - 2.5"	511-732	511-742	511-752	6	4
2.0 - 6.0"	511-733	511-743	511-753	11 (2" sub anvil)	4
4.0 - 6.5"	511-734	511-744	511-754	13	4
6.5 - 10"	511-735	511-745	511-755	6	7
10 - 16"	511-736	511-746	511-756	5 (3" sub anvil)	7
.7 - 6"	—	511-931	511-932	26 (2" sub anvil)	10

• Metric Gage Stem 8mm

Measuring Range	Order No. Without Indicator	Order No. With 2046SB Graduation 0.01mm	Order No. With 2109SB-10 Graduation 0.001mm	Number of Anvils	Number of Spacers
18 - 35mm	511-701	511-711	511-721	9	2
35 - 60mm	511-702	511-712	511-722	6	4
50 - 150mm	511-703	511-713	511-723	11 (50mm Sub Anvil)	4
100 - 160mm	511-704	511-714	511-724	13	4
160 - 250mm	511-705	511-715	511-725	6	7
250 - 400mm	511-706	511-716	511-726	5 (75mm Sub Anvil)	7
18 - 150mm	—	511-921 (3 pc set)	511-922 (3 pc set)	26 (50mm Sub Anvil)	10

Series 511 Short-leg Bore Gage



511-786

Short-leg Bore Gage



511-786

Measuring Heads



511-701/761/731/781

511-702/762/732/782

511-703/763/733/783

511-704/764/734/784

511-705/735

511-706/736

Specifications

•Inch

Gage Stem \varnothing 3/8"

Measuring Range	Order No. With 2922SB Graduation .0005"	Order No. With 2923SB-10 Graduation .0001"	Number of Anvils	Number of Spacers
.7 - 1.4"	511-786	511-791	9	2
1.4 - 2.5"	511-787	511-792	6	4
2.0 - 6.0"	511-788	511-793	11 (2" sub anvil)	4
4.0 - 6.5"	511-789	511-794	13	4

•Metric

Gage Stem 8mm

Measuring Range	Order No. With 2046SB Graduation 0.01mm	Order No. With 2109SB-10 Graduation 0.001mm	Number of Anvils	Number of Spacers
18 - 35mm	511-766	511-771	9	2
35 - 60mm	511-767	511-772	6	4
50 - 150mm	511-768	511-773	11 (50mm Sub Anvil)	4
100 - 160mm	511-769	511-774	13	4

Dimensions

Unit: mm

.7-1.4"/18-35mm

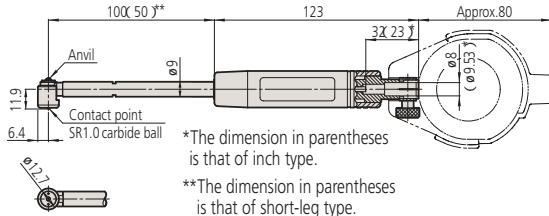

*The dimension in parentheses is that of inch type.

**The dimension in parentheses is that of short-leg type.

•Set of dial gage protective cover, retaining plate, and round-head Phillips screws: **No.21DZA000**

1.4-2.5"/35-60mm, 2-6"/50-150mm, 4-6.5"/100-160mm

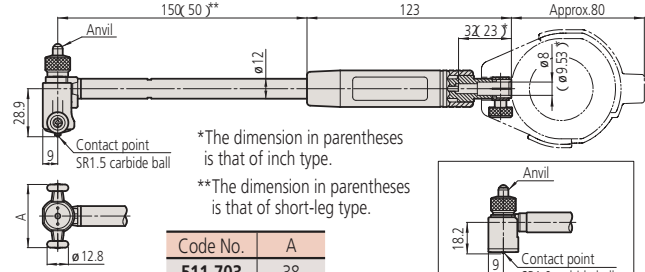

*The dimension in parentheses is that of inch type.

**The dimension in parentheses is that of short-leg type.

Code No.	A
511-703	38
511-704	50

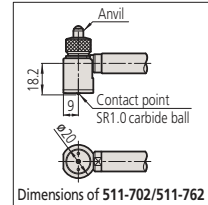

Dimensions of 511-702/511-762

Anvils

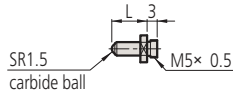

•Inch

Main unit	Marking	Size (inch)	L (inch)	Part No.
511-731 511-781	1	.709	.098	21DZA213A
	2	.787	.177	21DZA213B
	3	.866	.256	21DZA213C
	4	.945	.335	21DZA213D
	5	1.024	.413	21DZA213E
	6	1.102	.492	21DZA213F
	7	1.181	.571	21DZA213G
	8	1.260	.650	21DZA213H
	9	1.339	.728	21DZA213J

•Metric

Main unit	Marking	Size (mm)	L (mm)	Part No.
511-701 511-761	1	18	2.5	21DZA213A
	2	20	4.5	21DZA213B
	3	22	6.5	21DZA213C
	4	24	8.5	21DZA213D
	5	26	10.5	21DZA213E
	6	28	12.5	21DZA213F
	7	30	14.5	21DZA213G
	8	32	16.5	21DZA213H
	9	34	18.5	21DZA213J

Anvils

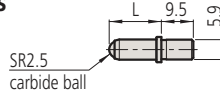

•Inch

Main unit	Marking	Size (inch)	L (inch)	Part No.
511-732 511-782	1	1.378	.217	21DZA232A
	2	1.575	.413	21DZA232B
	3	1.772	.610	21DZA232C
	4	1.969	.807	21DZA232D
	5	2.165	1.004	21DZA232E
	6	2.362	1.201	21DZA232F
511-733 511-783	1	1.969(3.969)	.217	21DZA232A
	2	2.165(4.165)	.413	21DZA232B
	3	2.362(4.362)	.610	21DZA232C
	4	2.559(4.559)	.807	21DZA232D
	5	2.756(4.756)	1.004	21DZA232E
	6	2.953(4.953)	1.201	21DZA232F
511-734 511-784	7	3.150(5.150)	1.398	21DZA232G
	8	3.346(5.346)	1.594	21DZA232H
	9	3.543(5.543)	1.791	21DZA232J
	10	3.740(5.740)	1.988	21DZA232L
	11	3.937(5.937)	2.185	21DZA232M
	1	3.937	.217	21DZA232A
	2	4.134	.413	21DZA232B
	3	4.331	.610	21DZA232C
	4	4.528	.807	21DZA232D
	5	4.724	1.004	21DZA232E
	6	4.921	1.201	21DZA232F
	7	5.118	1.398	21DZA232G
	8	5.315	1.594	21DZA232H
9	5.512	1.791	21DZA232J	
10	5.709	1.988	21DZA232L	
11	5.906	2.185	21DZA232M	
12	6.102	2.382	21DZA232N	
13	6.299	2.579	21DZA232P	

NOTE: Each dimension in parentheses is that of 511-733, indicating a size if the 2B sub-anvil is used.

•Metric

Main unit	Marking	Size (mm)	L (mm)	Part No.
511-702 511-762	1	35	5.5	21DZA232A
	2	40	10.5	21DZA232B
	3	45	15.5	21DZA232C
	4	50	20.5	21DZA232D
	5	55	25.5	21DZA232E
	6	60	30.5	21DZA232F
511-703 511-763	1	50(100)	5.5	21DZA232A
	2	55(105)	10.5	21DZA232B
	3	60(110)	15.5	21DZA232C
	4	65(115)	20.5	21DZA232D
	5	70(120)	25.5	21DZA232E
	6	75(125)	30.5	21DZA232F
511-704 511-764	7	80(130)	35.5	21DZA232G
	8	85(135)	40.5	21DZA232H
	9	90(140)	45.5	21DZA232J
	10	95(145)	50.5	21DZA232L
	11	100(150)	55.5	21DZA232M
	1	100	5.5	21DZA232A
	2	105	10.5	21DZA232B
	3	110	15.5	21DZA232C
	4	115	20.5	21DZA232D
	5	120	25.5	21DZA232E
	6	125	30.5	21DZA232F
	7	130	35.5	21DZA232G
	8	135	40.5	21DZA232H
9	140	45.5	21DZA232J	
10	145	50.5	21DZA232L	
11	150	55.5	21DZA232M	
12	155	60.5	21DZA232N	
13	160	65.5	21DZA232P	

NOTE: Each dimension in parentheses is that of 511-703, indicating a size if the 50mm sub-anvil is used.

Adjustment spacers

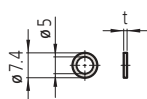

•Inch

t (inch)	Part No.
.02	205623
.04	205624

•Metric

t (mm)	Part No.
0.5	205623
1	205624

Wrench No.102148

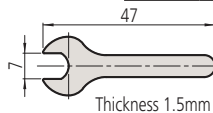

Adjustment spacers

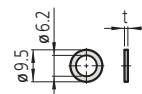

•Inch

t (inch)	Part No.
.02	205457
.04	205458
.08	205459
.12	205460

•Metric

t (mm)	Part No.
0.5	205457
1	205458
2	205459
3	205460

Sub-anvil (2") 50mm

(supplied only for 511-703/733/783)

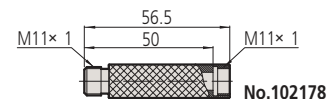

Dimensions

Unit: mm

6.5-10"/160-250mm, 10-16"/250-400mm

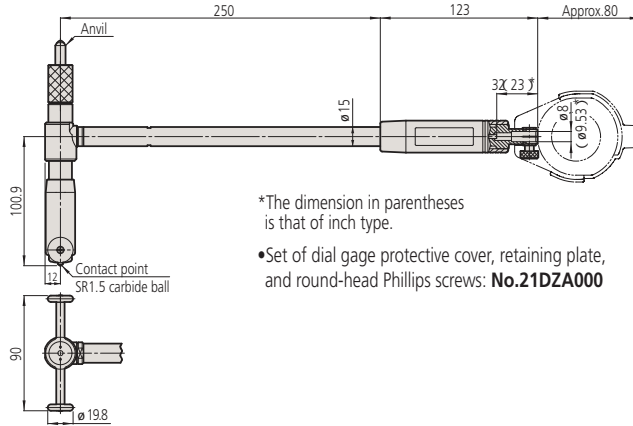

*The dimension in parentheses is that of inch type.

•Set of dial gage protective cover, retaining plate, and round-head Phillips screws: **No.21DZA000**

Anvils

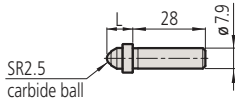

Adjustment spacers

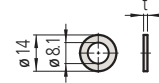

•Inch

Main unit	Marking	Size (inch)	L (inch)	Part No.
511-735	1	6.500	.394	21DZA241A
	2	7.091	.984	21DZA241B
	3	7.681	1.575	21DZA241C
	4	8.272	2.165	21DZA241D
	5	8.862	2.756	21DZA241E
	6	9.453	3.346	21DZA241F
511-736	1	10.000(13.000)	.394	21DZA241A
NOTE: Each dimension in parentheses is that of 511-736, indicating a size if the 3D sub-anvil is used.	2	10.591(13.591)	.984	21DZA241B
	3	11.181(14.181)	1.575	21DZA241C
	4	11.772(14.772)	2.165	21DZA241D
	5	12.362(15.362)	2.756	21DZA241E

•Metric

Main unit	Marking	Size (mm)	L (mm)	Part No.
511-705	1	160	10	21DZA241A
	2	175	25	21DZA241B
	3	190	40	21DZA241C
	4	205	55	21DZA241D
	5	220	70	21DZA241E
	6	235	85	21DZA241F
511-706	1	25(325)	10	21DZA241A
NOTE: Each dimension in parentheses is that of 511-706, indicating a size if the 75mm sub-anvil is used.	2	26(340)	25	21DZA241B
	3	28(355)	40	21DZA241C
	4	29(370)	55	21DZA241D
	5	31(385)	70	21DZA241E

•Inch

t (inch)	Part No.
.02	205467
.04	205461
.08	205462
.12	205463
.16	205464
.20	205465
.24	205466

•Metric

t (mm)	Part No.
0.5	205467
1	205461
2	205462
3	205463
4	205464
5	205465
6	205466

Sub-anvil (3") 75mm

(supplied only for 511-706 (202974) and 511-736 (202975))

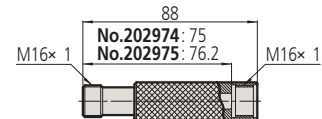

No.202974 (511-706)
No.202975 (511-736)

Series 511 Micrometer Head Bore Gage

Accuracy

- Wide-range accuracy: $2\ \mu\text{m}$ / $.00008''$
- Repeatability: $0.5\ \mu\text{m}$ / $.00002''$
- Adjacent error: $1\ \mu\text{m}$ / $.00004''$



511-813



511-814



511-804

(The dial gage and protective cover are optional.)



511-806

Measuring Heads



511-803/833 511-804/834 511-805/835 511-806/836



511-807/837 511-808/838

Specifications

• Inch Gage Stem ϕ 3/8"

Measuring Range	Order No. Without Indicator	Order No. With 2922SB Graduation $.0005''$	Order No. With 2923SB-10 Graduation $.0001''$	Mic Head Travel	Sub Anvil
2.4 - 4.0"	511-833	511-843	511-853	.4"	4", .8"
4.0 - 6.4"	511-834	511-844	511-854	.5"	4", .8", 8"
6.0 - 10"	511-835	511-845	511-855	.5"	4", .8", .8", 2"
10 - 16"	511-836	511-846	511-856	1"	1", 2", 2"
16 - 24"	511-837	511-847	511-857	2"	2", 4"
24 - 32"	511-838	511-848	511-858	2"	2", 4"

• Metric Gage Stem 8mm

Measuring Range	Order No. Without Indicator	Order No. With 2046SB Graduation 0.01mm	Order No. With 2109SB-10 Graduation 0.001mm	Mic Head Travel	Sub Anvil
60 - 100mm	511-803	511-813	511-823	10mm	10mm, 20mm
100 - 160mm	511-804	511-814	511-824	13mm	10mm, 20mm, 20mm
150 - 250mm	511-805	511-815	511-825	13mm	10mm, 20mm, 20mm, 50mm
250 - 400mm	511-806	511-816	511-826	25mm	25mm, 50mm, 50mm
400 - 600mm	511-807	511-817	511-827	50mm	50mm, 100mm
600 - 800mm	511-808	511-818	511-828	50mm	50mm, 100mm

Dimensions

Unit: mm

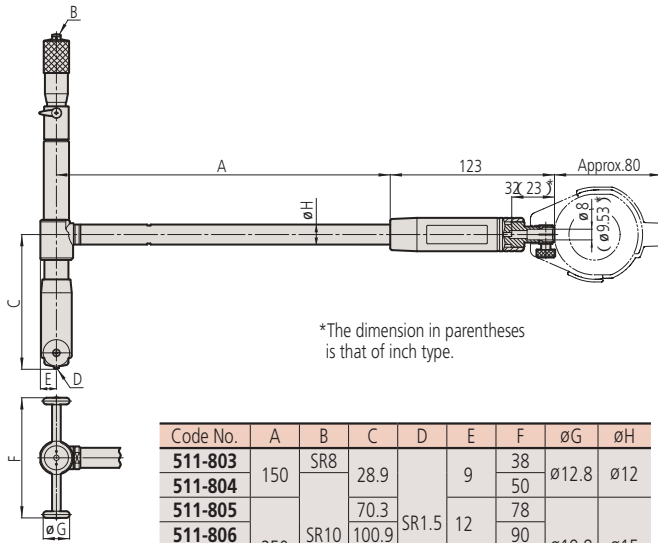

Code No.	A	B	C	D	E	F	øG	øH
511-803	150	SR8	28.9	SR1.5	9	38	ø12.8	ø12
511-804						50		
511-805	250	SR10	70.3	SR1.5	12	78	ø19.8	ø15
511-806			100.9			90		
511-807			200.9			120		
511-808			300.9		16			

Sub-anvils

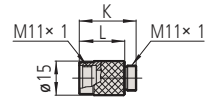

•Inch

Main unit	Marking	K (inch)	L (inch)	Part No.
511-833	.4	.6	.4	208893
511-834	.8	1	.8	208895
511-835	.4	.6	.4	208893
	.8	1	.8	208895
	2	2.2	2	21DAA493

•Metric

Main unit	Marking	K (mm)	L (mm)	Part No.
511-803	10	15	10	208892
511-804	20	25	20	208894
511-805	10	15	10	208892
	20	25	20	208894
	50	55	50	21DAA492

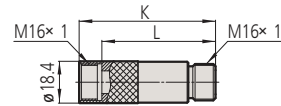

•Inch

Main unit	Marking	K (inch)	L (inch)	Part No.
511-836	1	1.4	1	208927
	2	2.4	2	208929
511-837	2	2.4	2	208929
511-838	4	4.4	4	208933

•Metric

Main unit	Marking	K (mm)	L (mm)	Part No.
511-806	25	35	25	208926
	50	60	50	208928
511-807	50	60	50	208928
511-808	100	110	100	208932

Wrenches

No. 202863

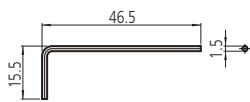

No. 301336

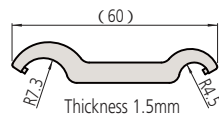

No. 200154

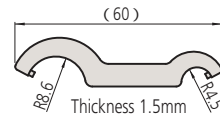

•Inch

Code No.	Part No.
511-833	301336 (2piece)
	202863 (1piece)
511-834	301336 (2piece)
511-835	301336 (2piece)
511-836	200154 (2piece)
511-837	200154 (2piece)
511-838	200154 (2piece)

•Metric

Code No.	Part No.
511-803	301336 (2piece)
	202863 (1piece)
511-804	301336 (2piece)
511-805	301336 (2piece)
511-806	200154 (2piece)
511-807	200154 (2piece)
511-808	200154 (2piece)

Bore Gage Accessories (Options)

Extension Rods

- Extension rods (optional) are available to assist in deep-hole measurement.
- When a rod is connected, there might be error margins due the distortion of the rod, etc.
In order to keep the error margins minimum, please don't connect more than 2 rods to a bore gage.
- The maximum extension is limited to 1,000 mm.
- If using an extension rod longer than 500 mm, use the bore gage only in the vertical orientation.

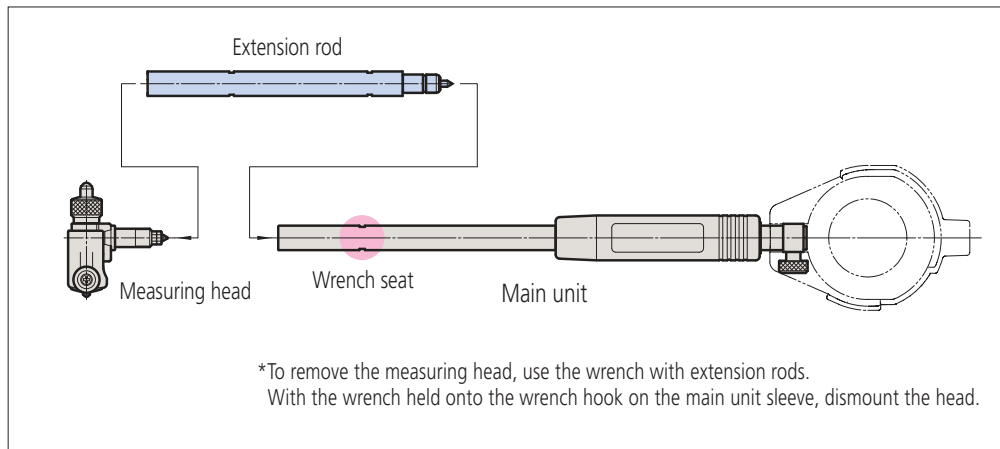

Specifications

Extension rod length					Extension rod diameter	Wrench Part No.	Applicable measuring range
125mm/5"	250mm/10"	500mm/20"	750mm/30"	1,000mm/40"			
953549	953550	953551	—	—	ø9	102148	18-35mm/0.7"-1.4"
953552	953553	953554	953555	953556	ø12	212556	35-60mm/1.4"-2.5"
							50-150mm/2"-6"
							100-160mm/4"-6.5"
							60-100mm/2.4"-4"
953557	952361	953558	953559	953560	ø15	212556	100-160mm/4.5"-6"
							160-250mm/6.5"-10"
							250-400mm/10"-16"
							150-250mm/6"-10"
							250-400mm/10"-16"
							400-600mm/16"-24"
							600-800mm/24"-32"

Dial Protection Cover

- It is possible to mount either flat back or lug-on-center back panels on the dial gage protective cover.

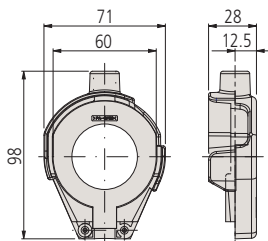
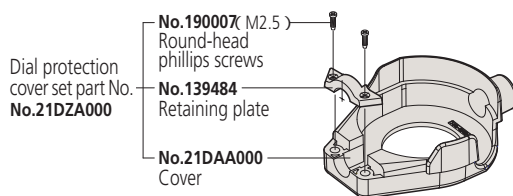

515-Series Bore Gage Zero-Checker

- The datum point of bore gages with a measuring range of 18 to 400mm can be easily set using an appropriate gage block in conjunction with this accessory.

• Specifications

Order No.	Datum point checking range (mm)
515-590	18-400 / .7"-16"

• Accuracy

Flatness of parallel jaws: 0.5 μ m (parallelism 1 μ m)

515-590
CCG-400



Standard configuration:

Stand
Attachment A, B, C (1 piece each)
Dedicated jaws (2 pieces)

177-Series Setting Rings

- These rings are used for checking the datum point of bore gages and others. Also, if a setting ring of an optimal size is prepared, it can be used for calibration. (For ordering details, refer to the Mitutoyo General Catalog No. US-1001.)

Steel setting rings



Ceramic setting rings





Note: All information regarding our products, and in particular the illustrations, drawings, dimensional and performance data contained in this printed matter as well as other technical data are to be regarded as approximate average values. We therefore reserve the right to make changes to the corresponding designs. The stated standards, similar technical regulations, descriptions and illustrations of the products were valid at the time of printing. In addition, the latest applicable version of our General Trading Conditions will apply. Only quotations submitted by ourselves may be regarded as definitive.

Mitutoyo products are subject to US Export Administration Regulations (EAR). Re-export or relocation of Mitutoyo products may require prior approval by an appropriate governing authority.

Trademarks and Registrations

Designations used by companies to distinguish their products are often claimed as trademarks. In all instances where Mitutoyo America Corporation is aware of a claim, the product names appear in initial capital or all capital letters. The appropriate companies should be contacted for more complete trademark and registration information.

We reserve the right to change specifications and prices without notice.

- Coordinate Measuring Machines
- Vision Measuring Systems
- Form Measurement
- Optical Measuring
- Sensor Systems
- Testing Equipment and Seismometer
- Digital Scale and DRO Systems
- Small Tool Instruments and Data Management

Mitutoyo America Corporation

www.mitutoyo.com

One Number to Serve You Better
1-888-MITUTOYO (1-888-648-8869)

M³ Solution Centers

- Aurora, Illinois
(Corporate Headquarters)
- Westford, Massachusetts
- Huntersville, North Carolina
- Mason, Ohio
- Plymouth, Michigan
- City of Industry, California

Mitutoyo
 Precision is our Profession