

THIS DRAWING IS UNPUBLISHED. RELEASED FOR PUBLICATION  
 © COPYRIGHT - By - ALL RIGHTS RESERVED.

| REVISIONS |               |             |          |         |
|-----------|---------------|-------------|----------|---------|
| P         | LTR           | DESCRIPTION | DATE     | APVD    |
| P1        | ECR-16-004636 |             | 16-06-30 | T.Q W.H |

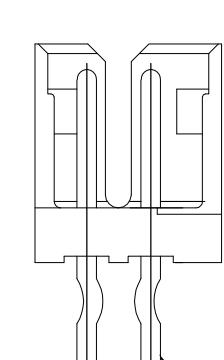
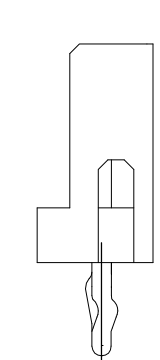
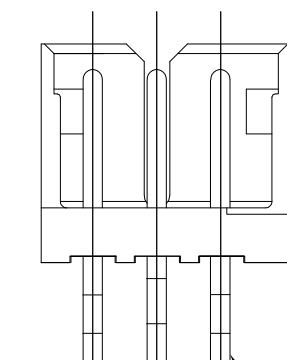
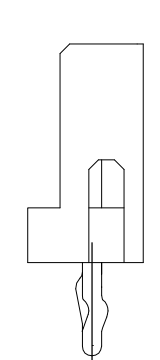
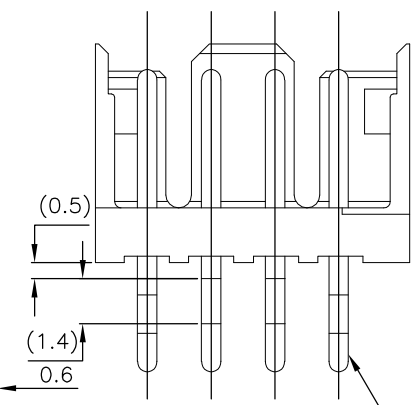
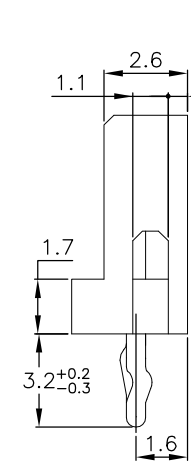
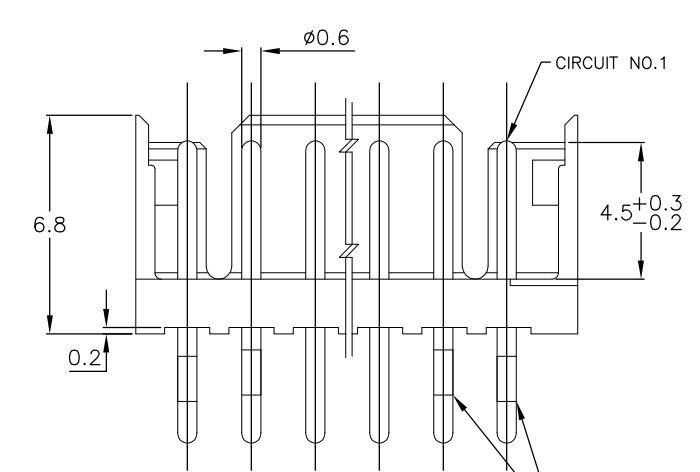
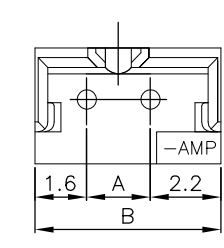
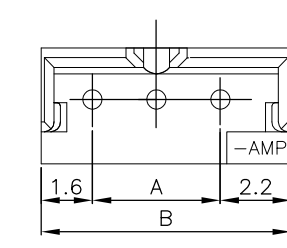
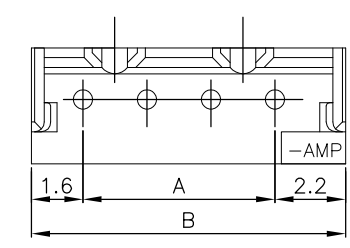
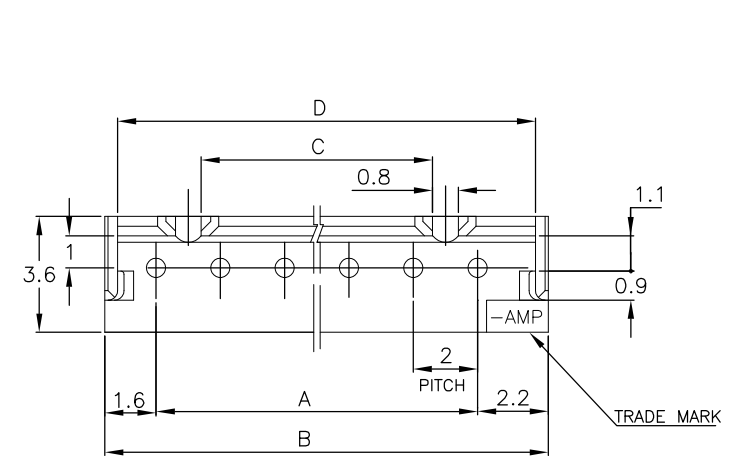

5~15 Pos.

4 POS.

3 POS.

2 POS.

NOTES:

- 1.MATERIAL: HOUSING - NYLON 66 (UL94V-0)  
POST - TIN BRASS
- 2.APPLICABLE RECEPTACLE P/N 173977
- 3.OBSOLETE RED COLOR PARTS.

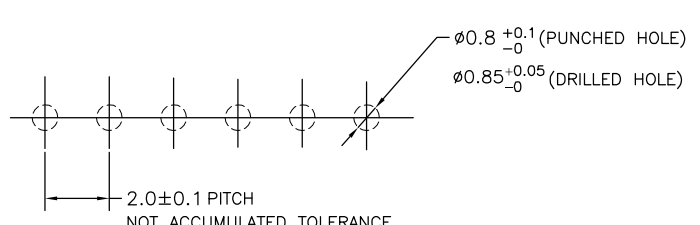

RECOMMENDABLE PCB LAYOUT  
(PCB THK:0.8-1.6)

| TOLERANCES UNLESS OTHERWISE SPECIFIED: |         |
|--|---------|
| 10 ≥ *                                 | : ±0.2  |
| 30 ≥ * > 10                            | : ±0.25 |
| 100 ≥ * > 30                           | : ±0.3  |
| ANGLE                                  | : ±3°   |

|            |            |            |            |            |      |    |      |      |      |
|------------|------------|------------|------------|------------|------|----|------|------|------|
|            | 7-292161-5 | 5-292161-5 | 3-292161-5 | 1-292161-5 | 15   | 28 | 31.8 | 25.2 | 31.0 |
|            | 7- ↑ -4    | 5- ↑ -4    | 3- ↑ -4    | 1- ↑ -4    | 14   | 26 | 29.8 | 23.2 | 29.0 |
|            | 7- -3      | 5- -3      | 3- -3      | 1- -3      | 13   | 24 | 27.8 | 21.2 | 27.0 |
| 9-292161-2 | 7- -2      | 5- -2      | 3- -2      | 1- -2      | 12   | 22 | 25.8 | 19.2 | 25.0 |
| 9- ↑ -1    | 7- -1      | 5- -1      | 3- -1      | 1- -1      | 11   | 20 | 23.8 | 17.2 | 23.0 |
| 9- = 0     | 7- -0      | 5- -0      | 3- -0      | 1- -0      | 10   | 18 | 21.8 | 15.2 | 21.0 |
| 8- -9      | 6- -9      | 4- -9      | 2- -9      |            | 9    | 16 | 19.8 | 13.2 | 19.0 |
| 8- -8      | 6- -8      | 4- -8      | 2- -8      |            | 8    | 14 | 17.8 | 11.2 | 17.0 |
| 8- -7      | 6- -7      | 4- -7      | 2- -7      |            | 7    | 12 | 15.8 | 9.2  | 15.0 |
| 8- -6      | 6- -6      | 4- -6      | 2- -6      |            | 6    | 10 | 13.8 | 7.2  | 13.0 |
| 8- -5      | 6- -5      | 4- -5      | 2- -5      |            | 5    | 8  | 11.8 | 5.2  | 11.0 |
| 8- -4      | 6- -4      | 4- -4      | 2- -4      |            | 4    | 6  | 9.8  | 3.2  | 9.0  |
| 8- ↓ -3    | 6- ↓ -3    | 4- ↓ -3    | 2- ↓ -3    |            | 3    | 4  | 7.8  | —    | 7.0  |
| 8-292161-2 | 6-292161-2 | 4-292161-2 | 2-292161-2 | 292161-2   | 2    | 2  | 5.8  | —    | 5.0  |
| RED        | BLACK      | YELLOW     | BLUE       | NATURAL    | Pos. | A  | B    | C    | D    |

|  |  |                        |  |                 |
|--|--|------------------------|--|-----------------|
| THIS DRAWING IS A CONTROLLED DOCUMENT. |  | DWN S.XU 31JAN03       | TE Connectivity  |                 |
|  |  | CHK S.YAO 31JAN03      |  |                 |
|  |  | APVD T. SASAKI 31JAN03 | NAME   |                 |
| DIMENSIONS: mm                         |  | PRODUCT SPEC 108-60016 | POST HEADER ASS'Y VERTICAL TYPE (AMP CT CONNECTOR 2mm PITCH) |                 |
| TOLERANCES UNLESS OTHERWISE SPECIFIED: |  | APPLICATION SPEC       |  |                 |
| MATERIAL SEE NOTE                      |  | WEIGHT 0.000000        | SIZE A3  | CAGE CODE 00779 |
|  |  | CUSTOMER DRAWING       | DRAWING NO C-292161  | RESTRICTED TO   |
|  |  |                        | SCALE 5:1  | SHEET 1 OF 2    |
|  |  |                        |  | REV P1          |

THIS DRAWING IS UNPUBLISHED.

RELEASED FOR PUBLICATION

© COPYRIGHT - By -

ALL RIGHTS RESERVED.

REVISIONS

| P | LTR | DESCRIPTION | DATE | DWN | APVD |
|---|-----|-------------|------|-----|------|
| - | -   | SEE SHEET 1 | -    | -   | -    |

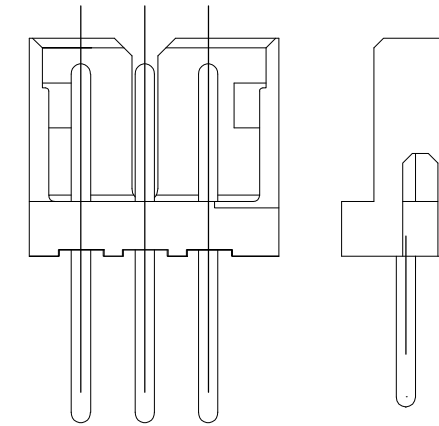
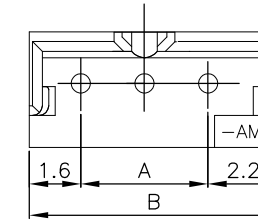
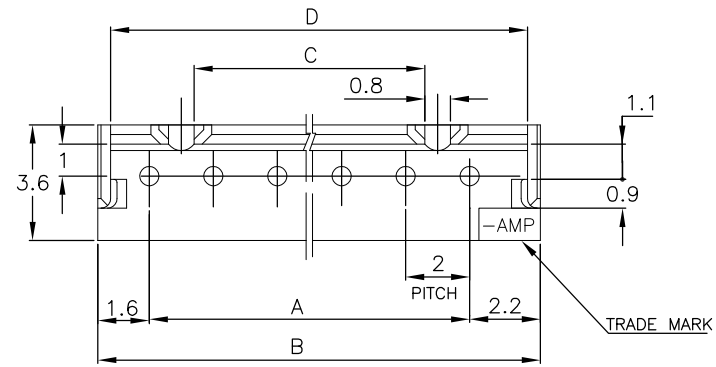

3 POS.

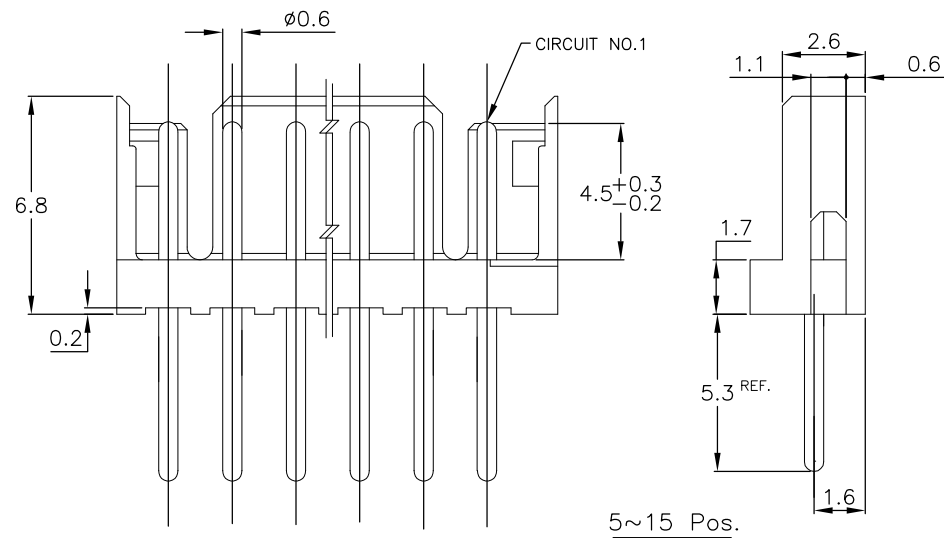

5~15 Pos.

NOTES:

- 1.MATERIAL: HOUSING - NYLON 66 (UL94V-0)  
POST - TIN BRASS
- 2.APPLICABLE RECEPTACLE P/N 173977

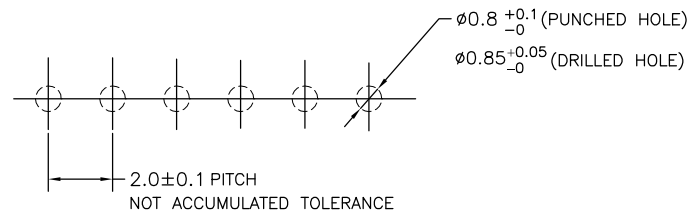

RECOMMENDABLE PCB LAYOUT (PCB THK:0.8-1.6)

TOLERANCES UNLESS OTHERWISE SPECIFIED:

- 10 ≥ \* : ±0.2
- 30 ≥ \* > 10 : ±0.25
- 100 ≥ \* > 30 : ±0.3
- ANGLE : ±3°

|            |      |    |      |     |      |
|------------|------|----|------|-----|------|
| 9-292161-7 | 7    | 12 | 15.8 | 9.2 | 15.0 |
| 9-292161-3 | 3    | 4  | 7.8  | -   | 7.0  |
| NATURAL    | Pos. | A  | B    | C   | D    |
| PART NO.   |      |    |      |     |      |

|  |  |                        |  |                  |                     |              |  |  |
|--|--|------------------------|--|------------------|---------------------|--------------|--|--|
| THIS DRAWING IS A CONTROLLED DOCUMENT. |  | DWN S.XU 31JAN03       | TE Connectivity<br>POST HEADER ASS'Y VERTICAL TYPE<br>(AMP CT CONNECTOR 2mm PITCH) |                  |                     |              |  |  |
| DIMENSIONS: mm                         |  | CHK S.YAO 31JAN03      |  |                  |                     | NAME         |  |  |
|  |  | APVD T. SASAKI 31JAN03 |  |                  |                     | PRODUCT SPEC |  |  |
|  |  |                        |  |                  |                     | 108-60016    |  |  |
| MATERIAL SEE NOTE                      |  | FINISH SEE NOTE        |  | APPLICATION SPEC |                     |              |  |  |
|  |  | WEIGHT 0.000000        | SIZE A3  | CAGE CODE 00779  | DRAWING NO C-292161 |              |  |  |
| CUSTOMER DRAWING                       |  |                        | SCALE 5:1  | SHEET 2 OF 2     | REV P1              |              |  |  |