

173725-1 ✓ ACTIVE

[Positive Lock](#) | [Positive Lock 187](#)

TE Internal #: 173725-1

Quick Disconnects, Receptacle, 20 – 14 AWG Wire Size, .51 – 2.08 mm² Wire Size, Mating Tab Width 4.75 mm [.187 in], Straight, Brass, Positive Lock 187

[View on TE.com >](#)



Terminals & Splices > Quick Disconnects

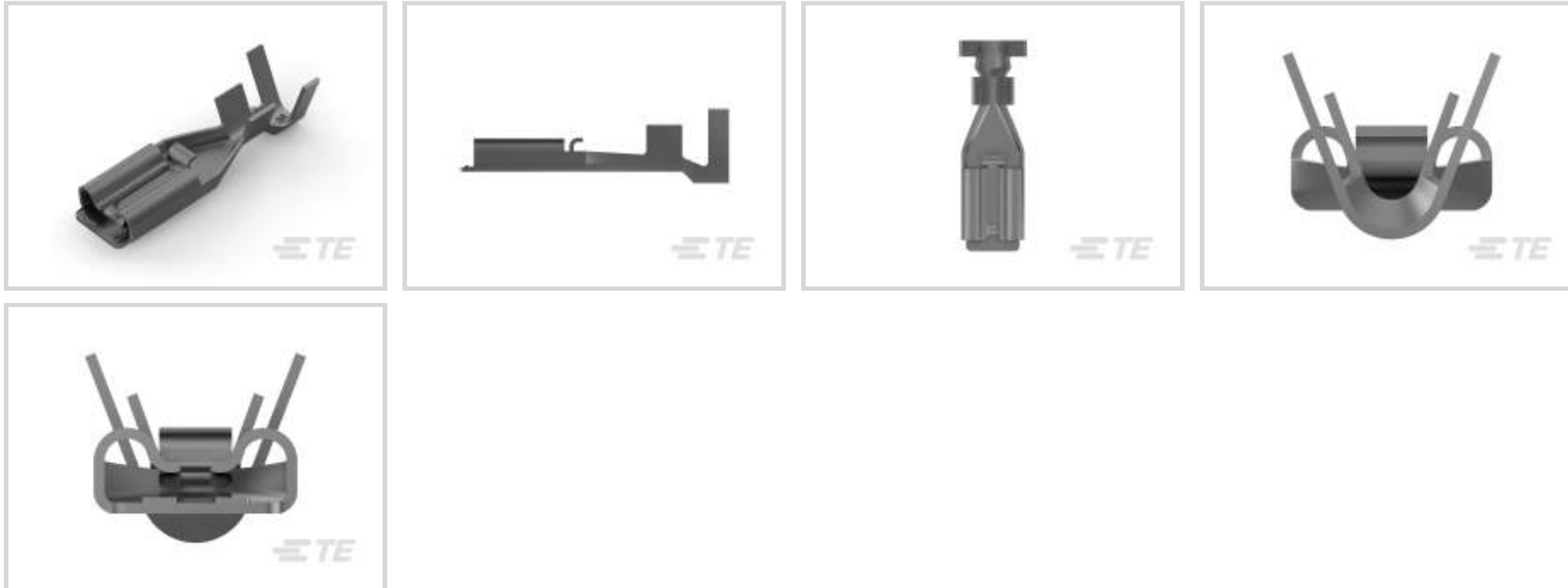

Quick Disconnect Terminal Type: **Receptacle**

Wire Size: **.51 – 2.08 mm²**

Mating Tab Width: **4.75 mm [.187 in]**

Mating Tab Thickness: **.51 mm [.02 in]**

Features

Product Type Features

Insertion Force	Low
-----------------	-----

Configuration Features

Compatible With Wire & Cable Type	Discrete Wire
-----------------------------------	---------------

Contact Features

Quick Disconnect Terminal Type	Receptacle
Mating Tab Width	4.75 mm[.187 in]
Mating Tab Thickness	.51 mm[.02 in]
Terminal Orientation	Straight
Contact Base Material	Brass
Terminal Plating Material	Pre-Tin
Crimp Type	F-Crimp
Barrel Type	Open

Termination Features

Product Terminates To	Wire & Cable
-----------------------	--------------



Mechanical Attachment

Extraction Force	7 – 100 Newton
Wire Insulation Support	With
Mating Retention Type	Dimple

Dimensions

Terminal Material Thickness	.3 mm[.012 in]
Product Length	17.2 mm[.68 in]
Compatible Insulation Diameter Range	1.9 – 4.45 mm[.075 – .173 in]
Wire Size	.51 – 2.08 mm ²

Usage Conditions

Insulation Option	Uninsulated
Operating Temperature Range	-40 – 110 °C[-40 – 230 °F]

Industry Standards

Agency/Standard	UL
-----------------	----

Packaging Features

Packaging Quantity	1000
Packaging Method	Loose Piece/Carton

Product Compliance

[For compliance documentation, visit the product page on TE.com>](#)

EU RoHS Directive 2011/65/EU	Compliant
EU ELV Directive 2000/53/EC	Compliant
China RoHS 2 Directive MIIT Order No 32, 2016	No Restricted Materials Above Threshold
EU REACH Regulation (EC) No. 1907/2006	Current ECHA Candidate List: JUNE 2023 (235) Candidate List Declared Against: JUNE 2023 (235) Does not contain REACH SVHC
Halogen Content	Low Halogen - Br, Cl, F, I < 900 ppm per homogenous material. Also BFR/CFR/PVC Free
Solder Process Capability	Not applicable for solder process capability

Product Compliance Disclaimer

This information is provided based on reasonable inquiry of our suppliers and represents our current actual knowledge based on the information they provided. This information is subject to change. The part numbers that TE has identified as



EU RoHS compliant have a maximum concentration of 0.1% by weight in homogenous materials for lead, hexavalent chromium, mercury, PBB, PBDE, DBP, BBP, DEHP, DIBP, and 0.01% for cadmium, or qualify for an exemption to these limits as defined in the Annexes of Directive 2011/65/EU (RoHS2). Finished electrical and electronic equipment products will be CE marked as required by Directive 2011/65/EU. Components may not be CE marked. Additionally, the part numbers that TE has identified as EU ELV compliant have a maximum concentration of 0.1% by weight in homogenous materials for lead, hexavalent chromium, and mercury, and 0.01% for cadmium, or qualify for an exemption to these limits as defined in the Annexes of Directive 2000/53/EC (ELV). Regarding the REACH Regulation, the information TE provides on SVHC in articles for this part number is based on the latest European Chemicals Agency (ECHA) 'Guidance on requirements for substances in articles' posted at this URL: <https://echa.europa.eu/guidance-documents/guidance-on-reach>

Compatible Parts



TE Part # 1743058-1
 PL 187 REC 22-16 AWG 0.3 X 22.8
 PTBR

Also in the Series | Positive Lock 187



Crimp Terminal Housings(86)



Insertion & Extraction Tools(2)



Insulation Boots & Sleeves(7)



Quick Disconnects(55)

Customers Also Bought



TE Part #5499374-9
 A/L UNIV HDR 40P VERT SHT LAT



TE Part #1-1776296-2
 TSB5001231DS=EUROPA T-BLK,10MM



TE Part #2301996-1
 RJ45 JACK INT.MAG. 10/100 1X2 INV.



TE Part #2822390-1
 070 ECONOSEAL MARK-2 PLUG 3P BLACK

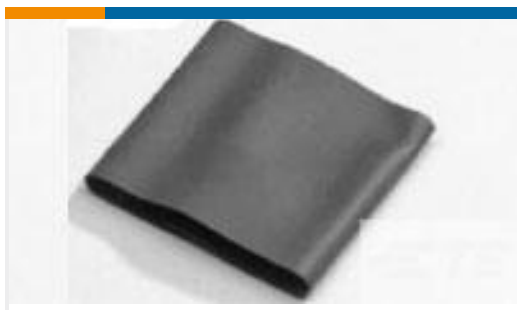

TE Part #580317J001
V2-8.0-0-FSP-SM

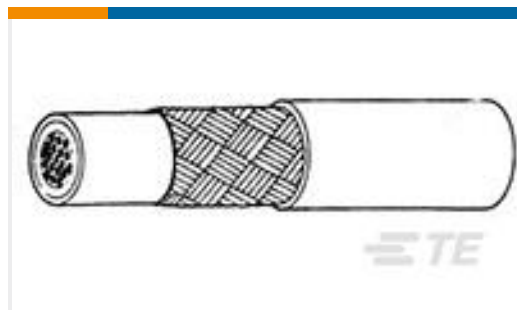

TE Part #331003-005
55A1111-22-9-9

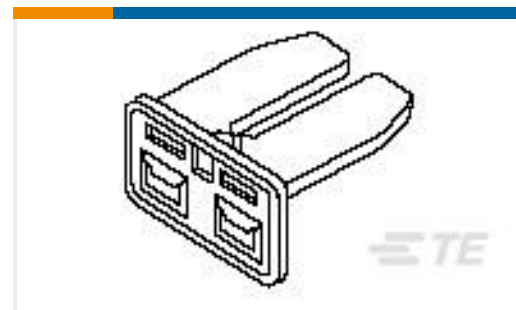

TE Part #174358-7
070 ECONOSEAL MARK-2 P/PLUG 3P



TE Part #175021-1
PL EX MKII 250 REC 22-18AWG PTBR LP



TE Part #CB0218-000
S200-1-W2-18-9

Documents

Product Drawings

[PL 187 REC TERMINAL 20-14 PTPB LP](#)

English

CAD Files

Customer View Model

[ENG_CVM_CVM_173725-1_U.2d_dxf.zip](#)

English

[3D PDF](#)

3D

Customer View Model

[ENG_CVM_CVM_173725-1_U.3d_igs.zip](#)

English

Customer View Model

[ENG_CVM_CVM_173725-1_U.3d_stp.zip](#)

English

By downloading the CAD file I accept and agree to the [Terms and Conditions](#) of use.

Product Specifications

[Application Specification](#)

English

Instruction Sheets

[Instruction Sheet \(non U.S.\)](#)

English

[POSITIVE LOCK EX CONTACT](#)

English

173725-1

Quick Disconnects, Receptacle, 20 – 14 AWG Wire Size, .51 – 2.08 mm² Wire Size,
Mating Tab Width 4.75 mm [.187 in], Straight, Brass, Positive Lock 187

