



IS 15885(Part 2/Sec13)  
R-41027766



## Features

- Constant Current mode output with multiple levels selectable by dip switch
- Plastic housing with class II design
- Built-in active PFC function
- Standby power consumption <0.5W
- Functions: 3 in 1 dimming (dim-to-off); synchronization up to 10 units
- 3 years warranty

## Applications

- LED indoor lighting
- LED office lighting
- LED architectural lighting
- LED panel lighting

## GTIN CODE

MW Search: <https://www.meanwell.com/serviceGTIN.aspx>

## Description

LCM-25 series is a 25W AC/DC constant current mode output LED driver featuring the multiple levels selectable by dip switch. LCM-25 operates from 180~277VAC and offers different current levels ranging between 350mA and 1050mA. Thanks to the efficiency up to 86%, with the fanless design, the entire series is able to operate for -30°C~+85°C case temperature under free air convection. LCM-25 is equipped with various functions, such as the dimming function and synchronization, so as to provide the optimal design flexibility for LED lighting system.

## Model Encoding

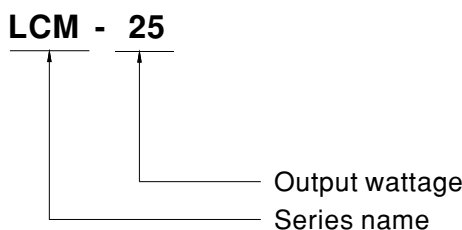



**SPECIFICATION**

<b>MODEL</b>		<b>LCM-25</b>					
<b>OUTPUT</b>	<b>CURRENT LEVEL</b>	Current level selectable via DIP switch, please refer to "DIP SWITCH TABLE" section					
		350mA	500mA	600mA	700mA(default)	900mA	1050mA
	<b>RATED POWER</b>	18.9W	25.2W				
	<b>DC VOLTAGE RANGE</b>	6 ~ 54V	6 ~ 50V	6 ~ 42V	6 ~ 36V	6 ~ 28V	6 ~ 24V
	<b>OPEN CIRCUIT VOLTAGE (max.)</b>	59V			41V		
	<b>CURRENT RIPPLE</b>	5.0% max. @rated current					
	<b>CURRENT TOLERANCE</b>	±5%					
	<b>SETUP TIME</b> Note.3	500ms / 230VAC					
<b>INPUT</b>	<b>VOLTAGE RANGE</b> Note.2	180 ~ 277VAC 254 ~ 392VDC (Please refer to "STATIC CHARACTERISTIC" section)					
	<b>FREQUENCY RANGE</b>	47 ~ 63Hz					
	<b>POWER FACTOR (Typ.)</b>	PF≥0.94/230VAC, PF≥0.91/277VAC @full load (Please refer to "POWER FACTOR (PF) CHARACTERISTIC" section)					
	<b>TOTAL HARMONIC DISTORTION</b>	THD< 20%(@load≥50%/230VAC; @load≥75%/277VAC) (Please refer to "TOTAL HARMONIC DISTORTION(THD)" section)					
	<b>EFFICIENCY (Typ.)</b> Note.4	86%					
	<b>AC CURRENT (Typ.)</b>	0.17A/230VAC		0.15A/277VAC			
	<b>INRUSH CURRENT (Typ.)</b>	COLD START 20A(width=260µs measured at 50% Ipeak) at 230VAC; Per NEMA 410					
	<b>MAX. No. of PSUs on 16A CIRCUIT BREAKER</b>	26 units (circuit breaker of type B) / 44 units (circuit breaker of type C) at 230VAC					
	<b>LEAKAGE CURRENT</b>	<0.5mA / 240VAC					
	<b>STANDBY POWER CONSUMPTION</b> Note.5	<0.5W					
<b>PROTECTION</b>	<b>SHORT CIRCUIT</b>	Constant current limiting, recovers automatically after fault condition is removed					
	<b>OVER TEMPERATURE</b>	Shut down o/p voltage, recovers automatically after temperature goes down					
<b>FUNCTION</b>	<b>DIMMING</b>	Please refer to "DIMMING OPERATION" section					
	<b>SYNCHRONIZATION</b>	Please refer to "SYNCHRONIZATION OPERATION" section					
<b>ENVIRONMENT</b>	<b>WORKING TEMP.</b>	Tcase=-30 ~ +85°C (Please refer to "OUTPUT LOAD vs TEMPERATURE" section)					
	<b>MAX. CASE TEMP.</b>	Tcase=+85°C					
	<b>WORKING HUMIDITY</b>	20 ~ 90% RH non-condensing					
	<b>STORAGE TEMP., HUMIDITY</b>	-40 ~ +80°C, 10 ~ 95% RH					
	<b>TEMP. COEFFICIENT</b>	±0.03%/°C (0 ~ 50°C)					
	<b>VIBRATION</b>	10 ~ 500Hz, 2G 10min./1cycle, period for 60min. each along X, Y, Z axes					
<b>SAFETY &amp; EMC</b>	<b>SAFETY STANDARDS</b>	UL8750, CSA C22.2 No.250.13-12, ENEC BS EN/EN61347-1, BS EN/EN61347-2-13, BS EN/EN62384 independent, GB19510.14,GB19510.1, BIS IS15885, EAC TP TC 004 approved					
	<b>WITHSTAND VOLTAGE</b>	I/P-O/P:3.75KVAC					
	<b>ISOLATION RESISTANCE</b>	I/P-O/P:>100M Ohms / 500VDC / 25°C / 70% RH					
	<b>EMC EMISSION</b>	Compliance to BS EN/EN55015, BS EN/EN61000-3-2 Class C(@load ≥ 50%) ; BS EN/EN61000-3-3; GB17625.1,GB17743, EAC TP TC 020					
	<b>EMC IMMUNITY</b>	Compliance to BS EN/EN61000-4-2,3,4,5,6,8,11, BS EN/EN61547, light industry level(surge immunity Line-Line 2KV), EAC TP TC 020					
<b>OTHERS</b>	<b>MTBF</b>	3298.3K hrs min. Telcordia SR-332 (Bellcore) ; 298.7K hrs min. MIL-HDBK-217F (25°C)					
	<b>DIMENSION</b>	105*68*23mm (L*W*H)					
	<b>PACKING</b>	0.16Kg ; 72pcs/12.5Kg/1.04CUFT					
<b>NOTE</b>	<ol style="list-style-type: none"> <li>All parameters NOT specially mentioned are measured at 230VAC input, rated current and 25°C of ambient temperature.</li> <li>De-rating may be needed under low input voltages. Please refer to "STATIC CHARACTERISTIC" sections for details.</li> <li>Length of set up time is measured at first cold start. Turning ON/OFF the driver may lead to increase of the set up time.</li> <li>Efficiency is measured at 500mA/50V output set by DIP switch.</li> <li>Standby power consumption is measured at 230VAC.</li> <li>The driver is considered as a component that will be operated in combination with final equipment. Since EMC performance will be affected by the complete installation, the final equipment manufacturers must re-qualify EMC Directive on the complete installation again.</li> <li>The ambient temperature derating of 3.5°C/1000m with fanless models and of 5°C/1000m with fan models for operating altitude higher than 2000m(6500ft).</li> <li>To fulfill requirements of the latest ErP regulation for lighting fixtures, this LED power supply can only be used behind a switch without permanently connected to the mains.</li> </ol> <p>※ Product Liability Disclaimer : For detailed information, please refer to <a href="https://www.meanwell.com/serviceDisclaimer.aspx">https://www.meanwell.com/serviceDisclaimer.aspx</a></p>						

### ■ BLOCK DIAGRAM

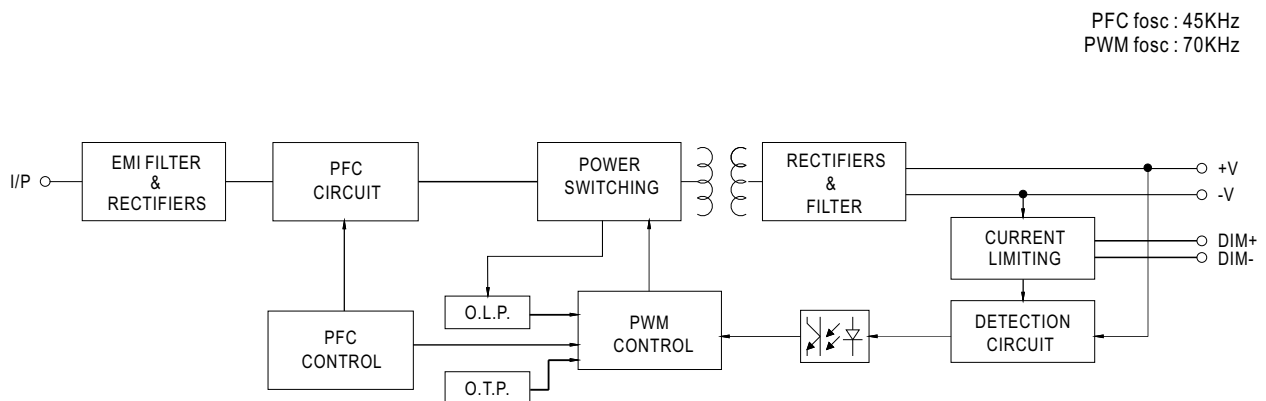

### ■ DIP SWITCH TABLE

LCM-25 is a multiple-stage constant current driver, selection of output current through DIP switch is exhibited below.

I <sub>o</sub>	DIP S.W.					
	1	2	3	4	5	6
350mA	----	----	----	----	----	----
500mA	ON	----	----	----	----	----
600mA	ON	ON	----	----	----	----
700mA(factory default)	ON	ON	ON	----	----	ON
900mA	ON	ON	ON	ON	----	ON
1050mA	ON	ON	ON	ON	ON	ON

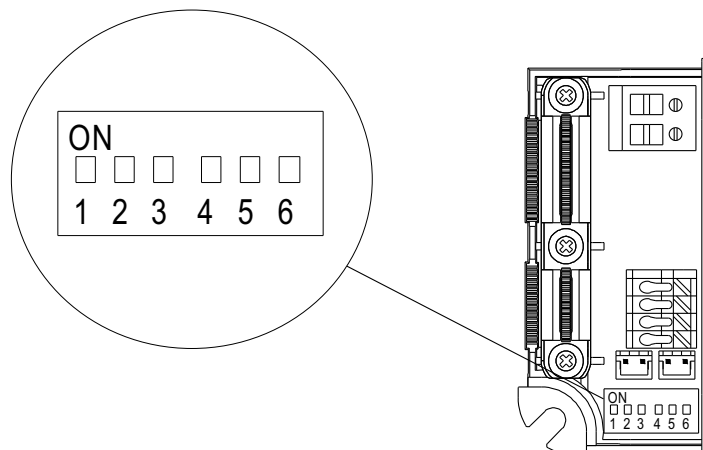

■ DIMMING OPERATION

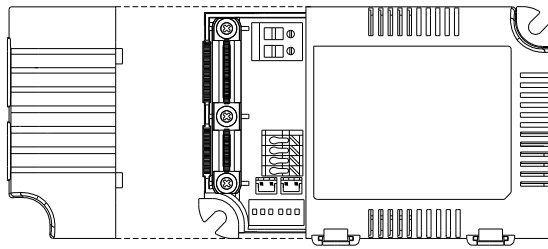

※ 3 in 1 dimming function

- Output constant current level can be adjusted by applying one of the three methodologies between DIM+ and DIM-: 0 ~ 10VDC, or 10V PWM signal or resistance.
- Direct connecting to LEDs is suggested. It is not suitable to be used with additional drivers.
- Dimming source current from power supply: 100 $\mu$ A (typ.)

◎ Applying additive 0 ~ 10VDC

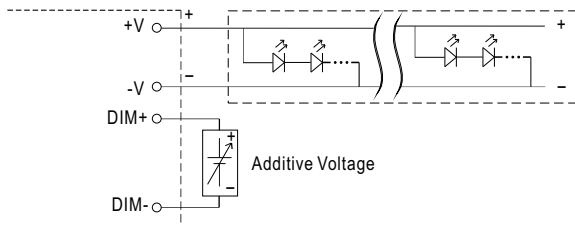

"DO NOT connect "DIM- to -V"

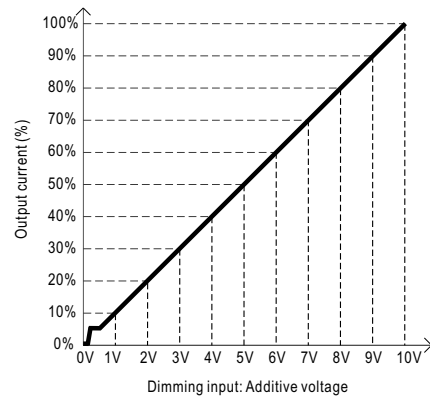

◎ Applying additive 10V PWM signal (frequency range 100Hz ~ 3KHz):

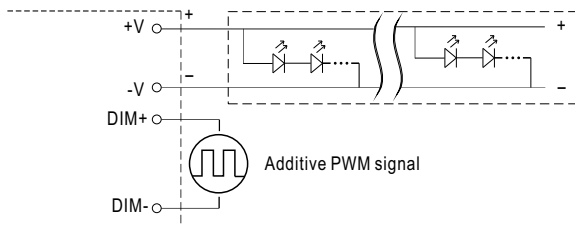

"DO NOT connect "DIM- to -V"

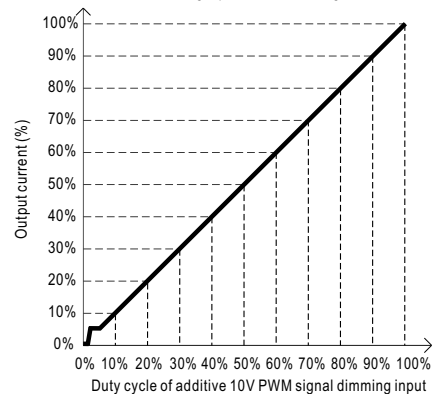

◎ Applying additive resistance:

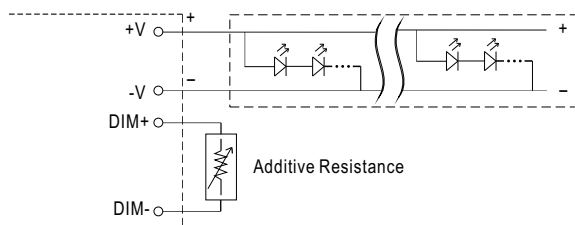

"DO NOT connect "DIM- to -V"

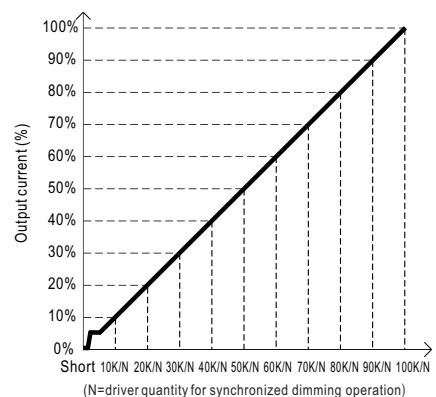

- Note : 1. Min. dimming level is about 6% and the output current is not defined when 0% < I<sub>out</sub> < 6%.  
 2. The output current could drop down to 0% when dimming input is about 0k $\Omega$  or 0Vdc, or 10V PWM signal with 0% duty cycle.  
 3. Please do not activate "temperature compensation" when performing dimming operation.

■ **SYNCHRONIZATION OPERATION**

- Synchronization up to 10 drivers (1 master + 9 slaves)
- Dimming operating range : 10%~100%
- Sync cable length : < 5m
- Sync cable type : Flat cable
- Sync cable cross section area : 22 – 24 AWG (0.2~0.3mm<sup>2</sup>)

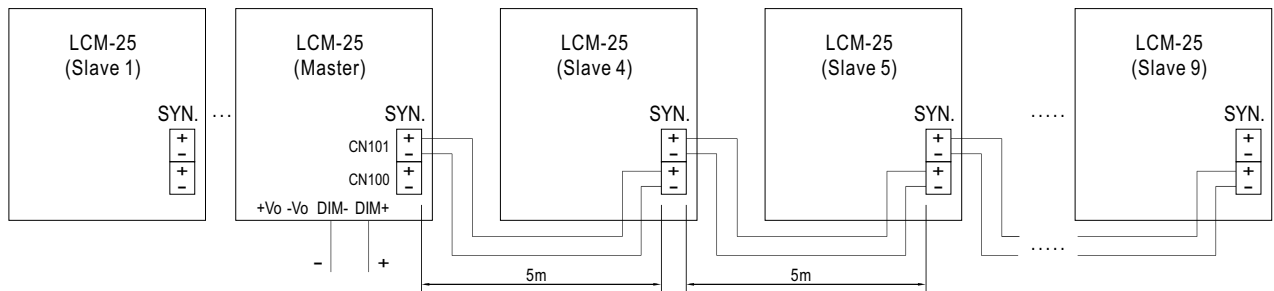

- CN100, CN101 : used to synchronously control the LCM units in parallel.

NOTE : 1. Please make sure all units are set to 100% dimming setting (factory default) before synchronizing.

2. Min. Dimming operating range depends on dimmer setting.

■ **OUTPUT LOAD vs TEMPERATURE**

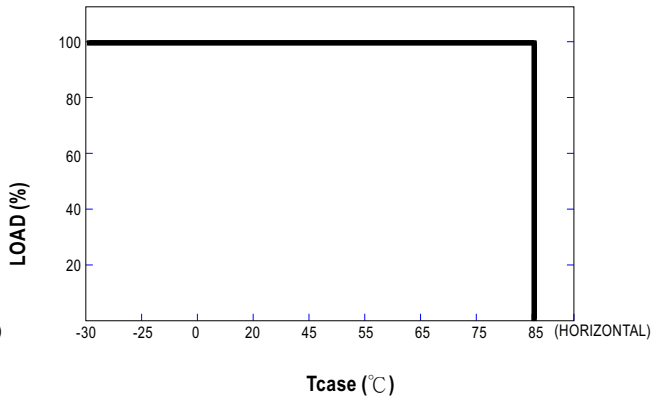
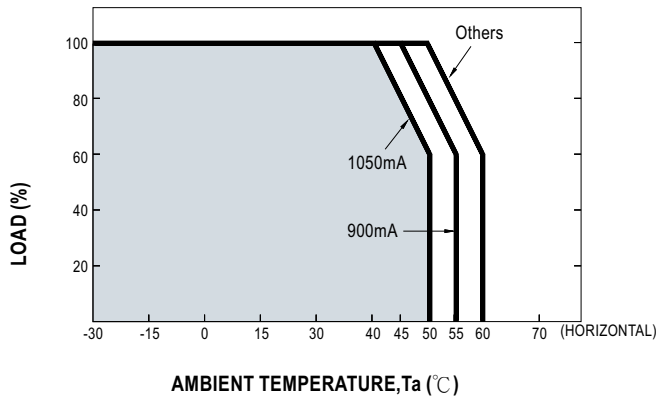

■ **STATIC CHARACTERISTIC**

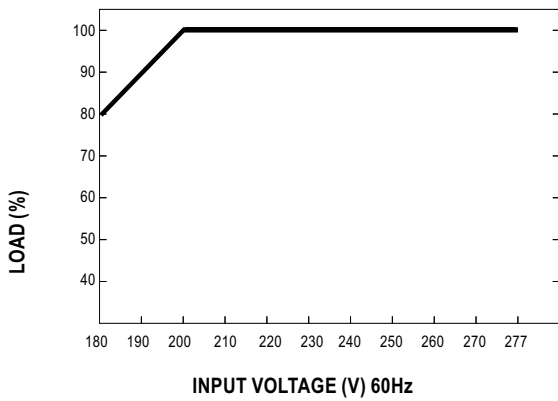

※ De-rating is needed under low input voltage.

**TOTAL HARMONIC DISTORTION (THD)**

※ Tcase at 75°C

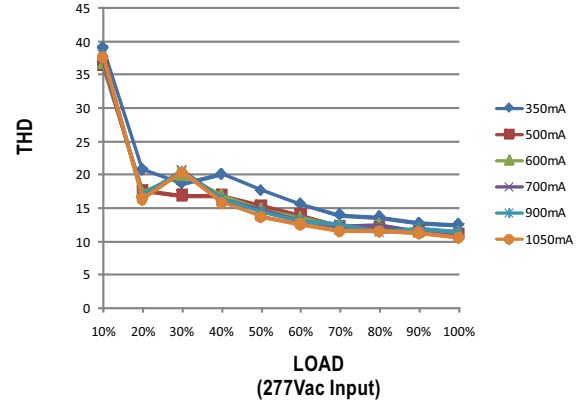
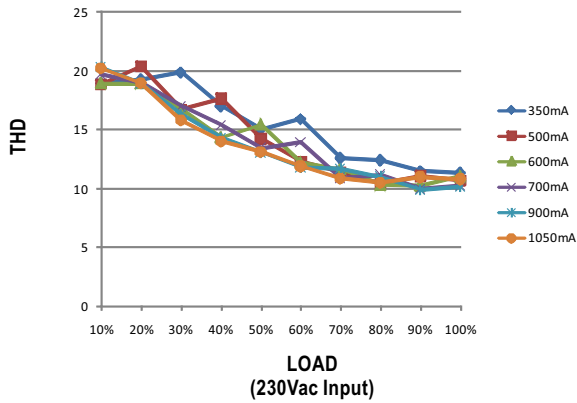

**POWER FACTOR (PF) CHARACTERISTIC**

※ Tcase at 75°C

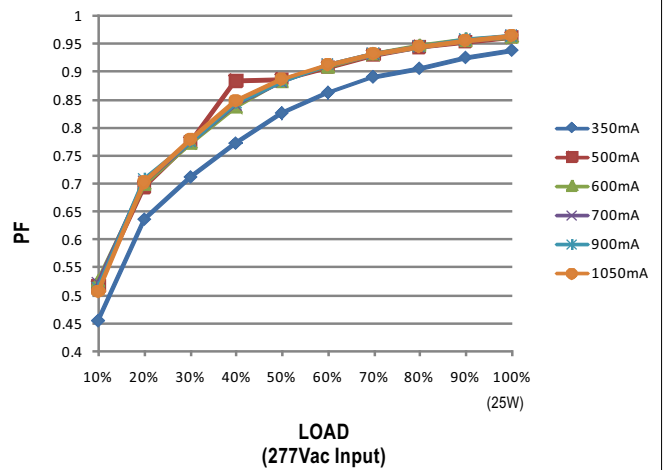
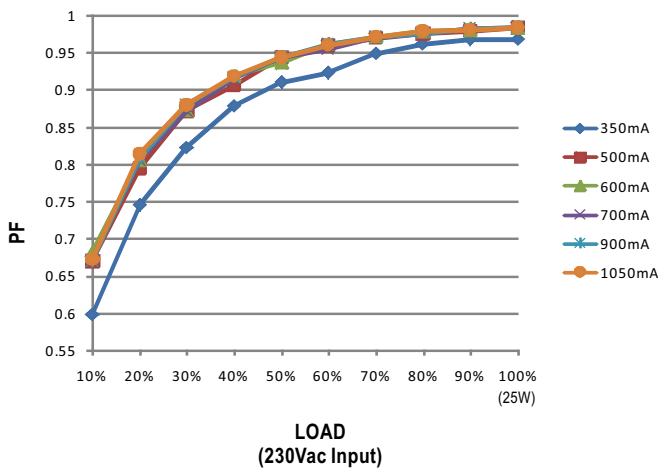

**EFFICIENCY vs LOAD**

LCM-25 series possess superior working efficiency that up to 86% can be reached in field applications.

※ Tcase at 75°C

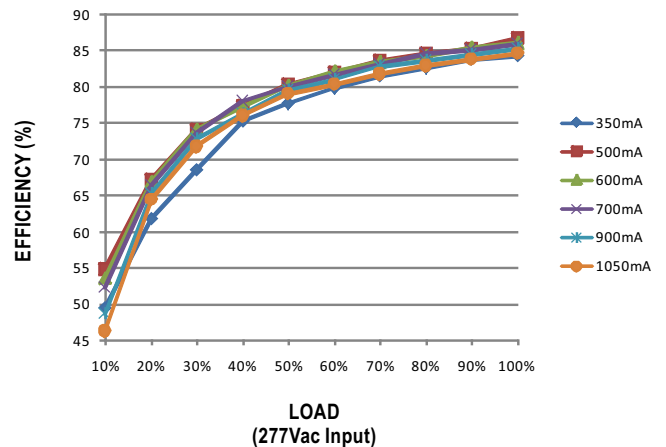
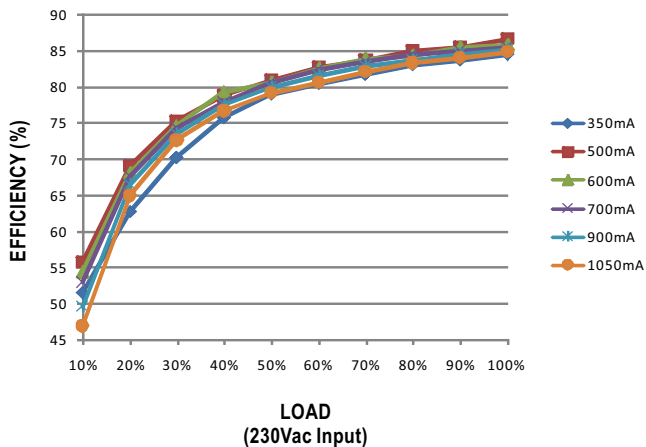

## MECHANICAL SPECIFICATION

Case No. LCM-25 Unit:mm

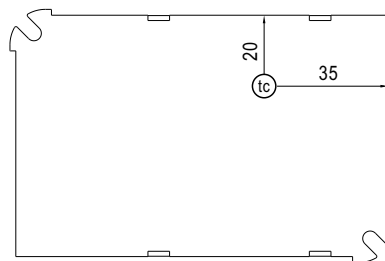
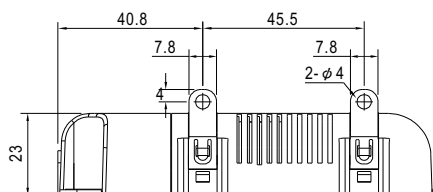
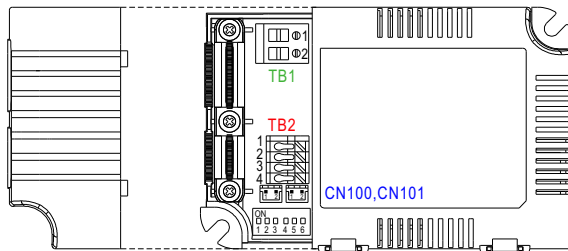
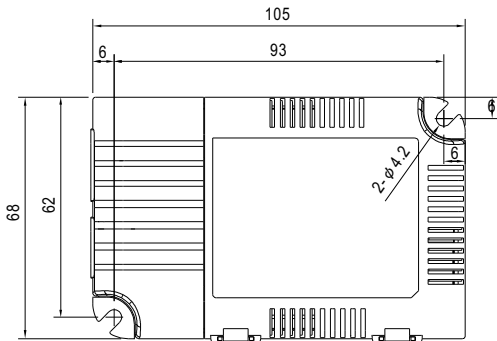

Bottom View

• (tc) : Max. Case Temperature

※ Terminal Pin No. Assignment(TB1)

Pin No.	Assignment
1	AC/L
2	AC/N

※ Terminal Pin No. Assignment(TB2)

Pin No.	Assignment	Pin No.	Assignment
1	+V	3	DIM-
2	-V	4	DIM+

※ SYN. Connector(CN100/CN101):JST B2B-PH-KL or equivalent

Pin No.	Assignment	Mating Housing	Terminal
1	-	JST PHR-2 or equivalent	JST SPH-002T-P0.5S or equivalent
2	+		

Note: Please use wires with a cross section of 0.5~2.5mm<sup>2</sup>(14~20AWG) for TB1 and wires with a cross section of 0.5~1.5 mm<sup>2</sup>(16~20AWG) for TB2. Please use wires with a cross section of 0.126~0.205mm<sup>2</sup>(24~26AWG) for CN100/CN101

## INSTALLATION MANUAL

Please refer to: <http://www.meanwell.com/manual.html>