

EM-0791

Shipped in packet-tape reel(5000pcs/Reel)

EM-0791 is ultra-small Hall effect ICs of a single silicon chip composed of Hall element and a signal processing IC.

Unipolar Hall Effect Switch
Two output for S and N-pole

Supply Voltage
1.6~5.5V

Hall Element Pulse Excitation

High Sensitivity
Bop:2.5mT

Output CMOS
Two output for S and N-pole

SON

Notice:It is requested to read and accept "IMPORTANT NOTICE" written on the back of the front cover of this catalogue.

Operational Characteristics

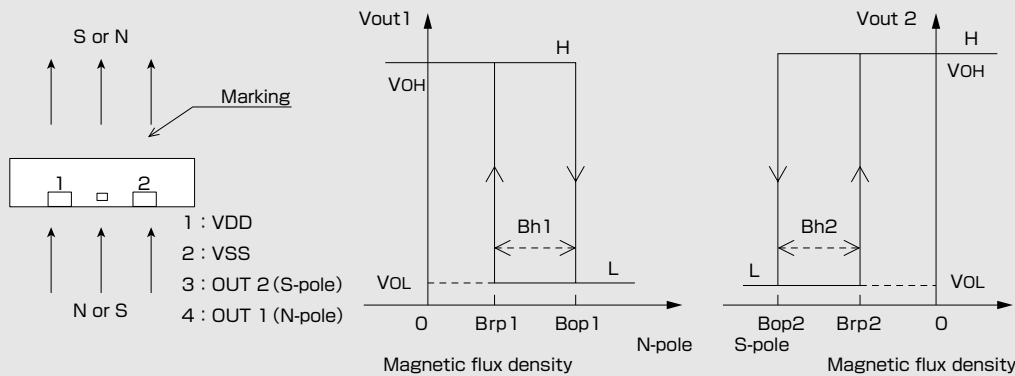

Absolute Maximum Ratings (Ta=25°C)

Item	Symbol	Limit	Unit
Supply Voltage	VDD	-0.1 ~ 6.0	V
Output Current	I _{out}	±0.5	mA
Operating Temperature Range	Topr	-30 ~ +85	°C
Storage Temperature Range	Tstg	-40 ~ +125	°C

Functional Block Diagram

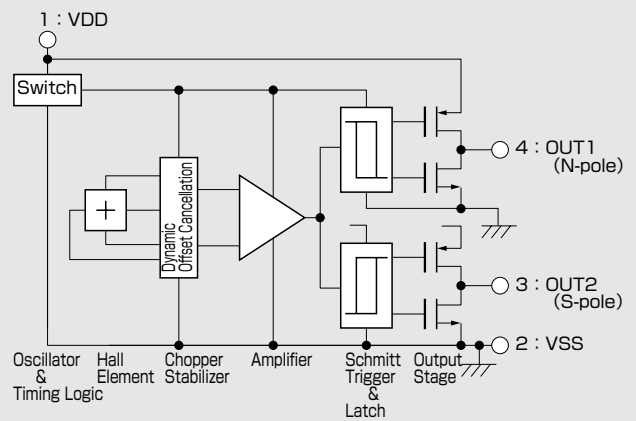

Magnetic ① and Electrical Characteristics (Ta=25°C VDD=1.85V)

Item	Symbol	Conditions	Min.	Typ.	Max.	Unit
Supply Voltage	VDD		1.6		5.5	V
Operating Point	B _{Op1}		*1.4	2.5	3.2	mT
	B _{Op2}		-3.2	-2.5	*-1.4	
Release Point	B _{rp1}		1.2	2.0	*3.0	mT
	B _{rp2}		*-3.0	-2.0	-1.2	
Hysteresis	B _{h1} , B _{h2}			0.5		mT
Period	T _p			50	100	ms
Output High Voltage	V _{OH}	I _o =-0.2mA	VDD-0.4			V
Output Low Voltage	V _{OL}	I _o =+0.2mA			0.4	V
Supply Current	I _{DD}	Average		6.5	9	μA

1 [mT]=10 [Gauss]

* The characteristics with [*] marks are design targets.
* OUT1 responds to the positive flux from the north pole(Bop1,Brp1), OUT2 to the negative flux from the south pole(Bop2,Brp2).

Magnetic Characteristics ② (Ta=-30~+85°C VDD=1.85V)

Item	Symbol	Conditions	Min.	Typ.	Max.	Unit
Operating Point	B _{OpS}		1.3	2.5	3.5	mT
	B _{OpN}					
Release Point	B _{rpS}		1.1	2.0	3.3	mT
	B _{rpN}					
Hysteresis	B _{hS}			0.5		mT
	B _{hN}					

Note) The above specifications are design targets.

Application Circuit

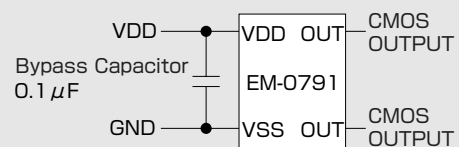

•Please be aware that our products are not intended for use in life support equipment, devices, or systems. Use of our products in such applications requires the advance written approval of our sales staff.
 Certain applications using semiconductor devices may involve potential risks of personal injury, property damage, or loss of life. In order to minimize these risks, adequate design and operating safeguards should be provided by the customer to minimize inherent or procedural hazards. Inclusion of our products in such applications is understood to be fully at the risk of the customer using our devices or systems.

●Package (Unit:mm)

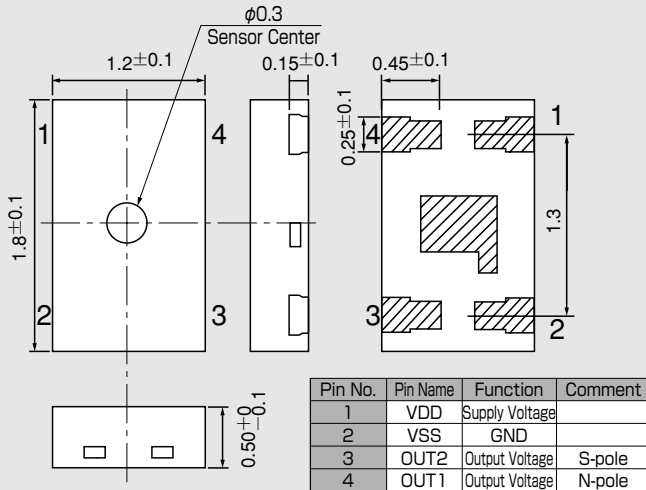

※Note1) The sensor center is located within the φ0.3mm circle.
 Note2) The tolerances of dimensions with no mentions is ±0.1mm.
 Note3) Coplanarity: The differences between standoff of terminals are max.50μm.
 Note4) Shaded area is plating area

●(For reference only)Land Pattern (Unit:mm)

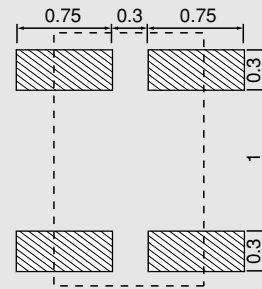

Note5) The center shadow area of the bottom of HIC does not need to be soldered. This area shares the lead frame with VSS inside the package and please be careful not to short this area to pins except No.2.

●Function Timing Chart

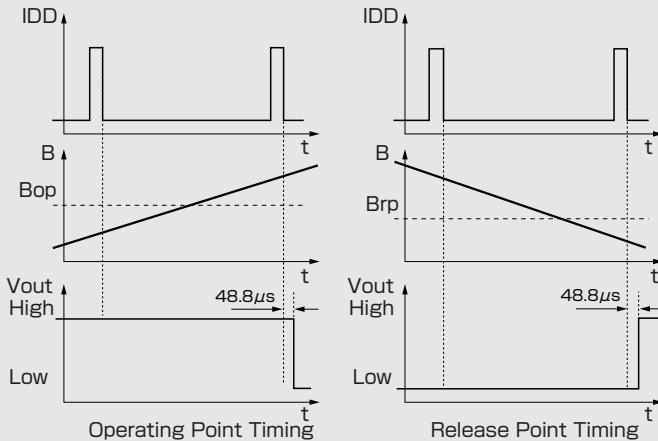

This Hall IC's output is held as internal data just before the internal circuit turns OFF (IDD OFF). And after 48.8 μs, the output changes.
 Note) 48.8 μs in figures is typical value

●IDD Pulse Driving (VDD=1.85V)

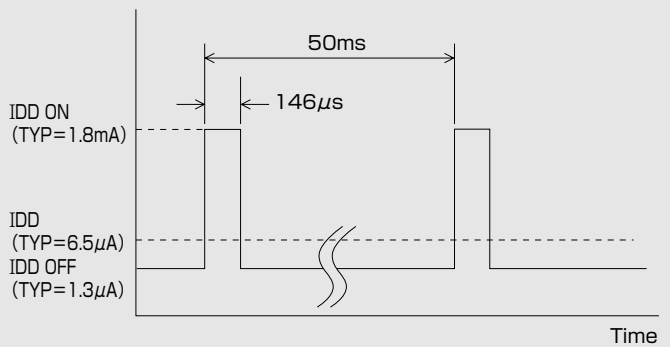

●Supply Voltage

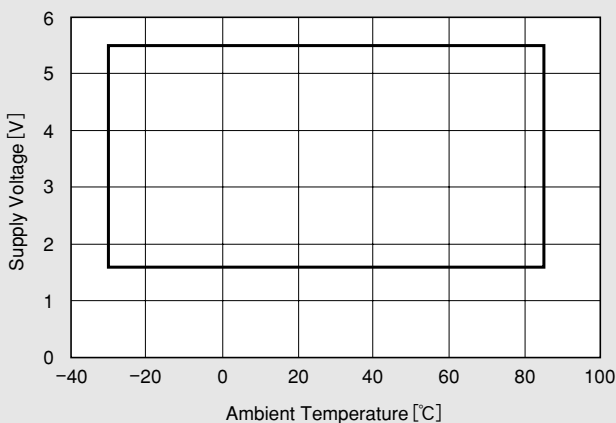

●Temperature Dependence of Bop, Brp

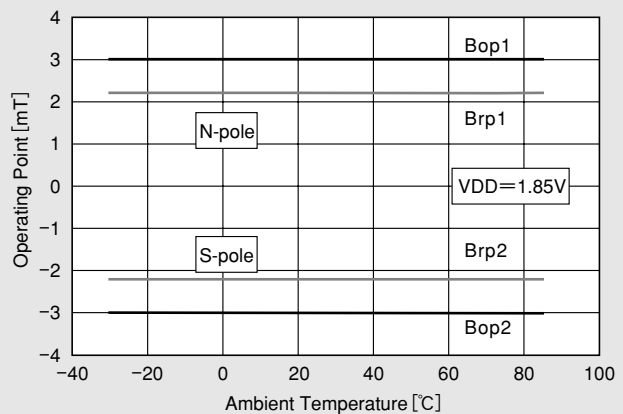

IMPORTANT NOTICE

- These products and their specifications are subject to change without notice. When you consider any use or application of these products, please make inquiries the sales office of Asahi Kasei Microdevices Corporation (AKM) or authorized distributors as to current status of the products.
- Descriptions of external circuits, application circuits, software and other related information contained in this document are provided only to illustrate the operation and application examples of the semiconductor products. You are fully responsible for the incorporation of these external circuits, application circuits, software and other related information in the design of your equipments. AKM assumes no responsibility for any losses incurred by you or third parties arising from the use of these information herein. AKM assumes no liability for infringement of any patent, intellectual property, or other rights in the application or use of such information contained herein.
- Any export of these products, or devices or systems containing them, may require an export license or other official approval under the law and regulations of the country of export pertaining to customs and tariffs, currency exchange, or strategic materials.
- AKM products are neither intended nor authorized for use as critical components^{Note1)} in any safety, life support, or other hazard related device or system^{Note2)}, and AKM assumes no responsibility for such use, except for the use approved with the express written consent by Representative Director of AKM. As used here:
 - Note1) A critical component is one whose failure to function or perform may reasonably be expected to result, whether directly or indirectly, in the loss of the safety or effectiveness of the device or system containing it, and which must therefore meet very high standards of performance and reliability.
 - Note2) A hazard related device or system is one designed or intended for life support or maintenance of safety or for applications in medicine, aerospace, nuclear energy, or other fields, in which its failure to function or perform may reasonably be expected to result in loss of life or in significant injury or damage to person or property.
- It is the responsibility of the buyer or distributor of AKM products, who distributes, disposes of, or otherwise places the product with a third party, to notify such third party in advance of the above content and conditions, and the buyer or distributor agrees to assume any and all responsibility and liability for and hold AKM harmless from any and all claims arising from the use of said product in the absence of such notification.

June 2, 2010