



The Future of Analog IC Technology®

MP8200

1.0V Precision Shunt Voltage Regulator

DESCRIPTION

The MP8200 is a low voltage (1.0V), precision shunt regulator. It is offered in both fixed versions. It can operate from 1V to 12V, giving designers outstanding flexibility in the development of power supplies and instrumentation. The operating current of 100uA makes the part well suited for battery-powered portable electronic applications. The 8200 regulates the output voltage from as low as 1V. The part has a sharp turn-on characteristic and a dynamic resistance of less than 0.5Ω.

The MP8200 is offered in a surface mounted 3-pin SOT23 package. Different voltage tolerance ±1%.

FEATURES

- Wide Input Voltage Range (1V to 12V)
- Operating Current From 100µA to 10mA
- Ultra compact SOT23-3 Package
- Initial Accuracy: ±1%
- Low Dynamic Output Resistance of 0.5Ω
- Stable With No External Capacitor
- Temperature Range: -40°C to +85°C

APPLICATIONS

- Adjustable and Programmable Supplies
- Instrumentation
- Linear Regulators
- Notebook Computers
- Medical Electronics
- 3V/ 5V 8-/12 Bit Data Converters
- Battery-Powered Equipments

"MPS" and "The Future of Analog IC Technology" are Registered Trademarks of Monolithic Power Systems, Inc.

TYPICAL APPLICATION

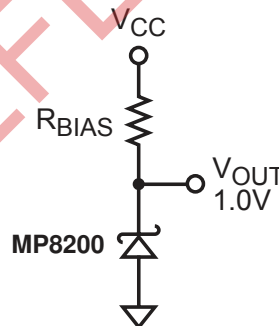

ORDERING INFORMATION

| Part Number* | Package | Top Marking | Temperature |
|--------------|---------|-------------|----------------|
| MP8200DT | SOT23-3 | IS3YW | -40°C to +85°C |

* For Tape & Reel, add suffix -Z (eg. MP8200DT-Z). For RoHS compliant packaging, add suffix -LF (eg. MP8200DT-LF-Z)

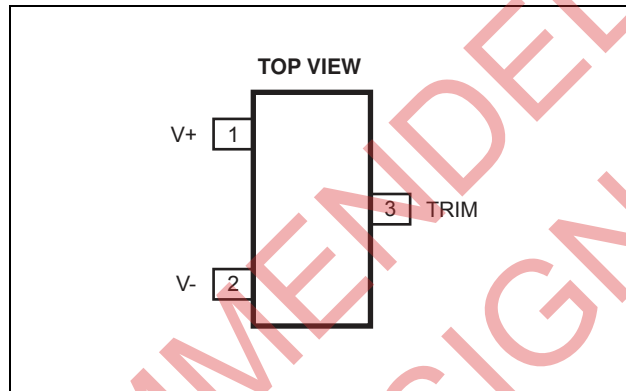
PACKAGE REFERENCE

ABSOLUTE MAXIMUM RATINGS ⁽¹⁾

| | |
|---|-----------------|
| Reverse Current | 25mA |
| Forward Current..... | 20mA |
| Continuous Power Dissipation ($T_A = +25^\circ\text{C}$) ⁽²⁾ | 0.52W |
| Junction Temperature..... | 150°C |
| Lead Temperature | 260°C |
| Storage Temperature | -65°C to +150°C |

Recommended Operating Conditions ⁽³⁾

| | |
|----------------------------|----------------|
| Input Voltage..... | 1V to 12V |
| Output Voltage..... | 1.0V |
| Operating Temperature..... | -40°C to +85°C |

| Thermal Resistance ⁽⁴⁾ | θ_{JA} | θ_{JC} |
|-----------------------------------|---------------|---------------|
| SOT23-3 | 240 | 110.. °C/W |

Notes:

- 1) Exceeding these ratings may damage the device.
- 2) The maximum allowable power dissipation is a function of the maximum junction temperature T_J (MAX), the junction-to-ambient thermal resistance θ_{JA} , and the ambient temperature T_A . The maximum allowable continuous power dissipation at any ambient temperature is calculated by P_D (MAX) = $(T_J$ (MAX) - T_A) / θ_{JA} . Exceeding the maximum allowable power dissipation will cause excessive die temperature, and the regulator will go into thermal shutdown. Internal thermal shutdown circuitry protects the device from permanent damage.
- 3) The device is not guaranteed to function outside of its operating conditions.
- 4) Measured on approximately 1" square of 1 oz copper.

ELECTRICAL CHARACTERISTICS

$I_{IN} = 100\mu\text{A}$ to 10mA , $T_A = +25^\circ\text{C}$, unless otherwise noted.

| Parameter | Symbol | Condition | Min | Typ | Max | Units |
|---|-----------------------------|---|-------|--------|-------|-----------------------|
| Output Voltage ⁽⁵⁾ | V_O | | 0.990 | 1.0000 | 1.010 | V |
| Initial Accuracy | V_{OERR} | | -10 | | +10 | mV |
| | | | -1 | | +1 | % |
| Temperature Coefficient A Grade | TCV_O | $-40^\circ\text{C} < T_A < +85^\circ\text{C}$ | | 45 | | ppm/ $^\circ\text{C}$ |
| | | -40°C to $+85^\circ\text{C}$ | | | 85 | |
| Output Voltage Change vs. Input Voltage | ΔV_R | $I_{IN} = 0.1\text{mA}$ to 10mA | | 4 | 5 | mV |
| Dynamic Output Impedance | $(\Delta V_R / \Delta I_R)$ | $I_{IN} = 2\text{mA} \pm 100\mu\text{A}$ | | 0.5 | | Ω |
| Minimum Operating Current | I_{IN} | $0^\circ\text{C} < T_A < +70^\circ\text{C}$ | 100 | | | μA |
| Voltage Noise | | $f = 0.1\text{Hz}$ to 10Hz | | 4 | | $\mu\text{V p-p}$ |
| Turn-On Settling Time | t_R | Within 0.1% of Output | | 10 | | μs |

Notes:

5) The forward diode voltage characteristic at -1mA is typically 0.65V .

PIN FUNCTIONS

| Pin # | Name | Description |
|-------|------|-------------|
| 1 | V+ | Cathode |
| 2 | V- | Anode |
| 3 | TRIM | No Connect |

TYPICAL PERFORMANCE CHARACTERISTICS
 $V_{IN} = 5V, V_{OUT} = 1V, T_A = +25^{\circ}C$, unless otherwise noted.

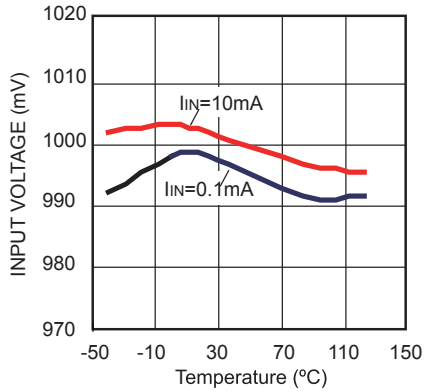
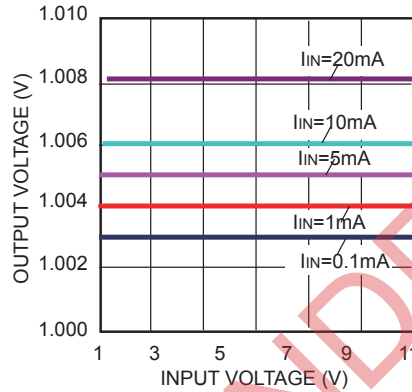
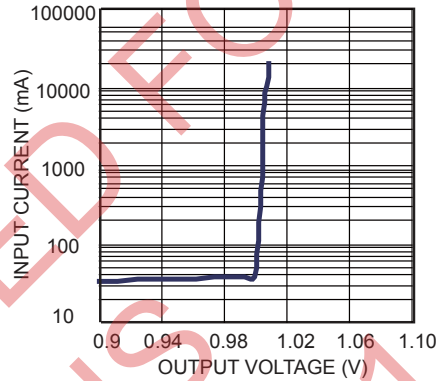
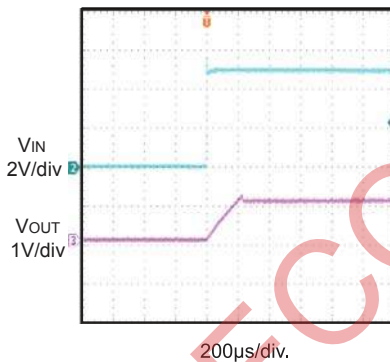
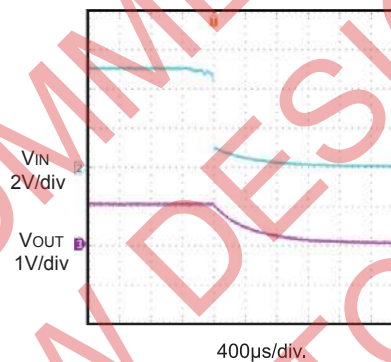
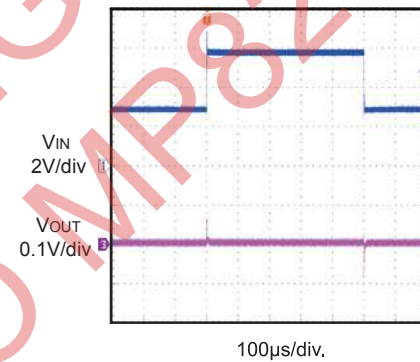
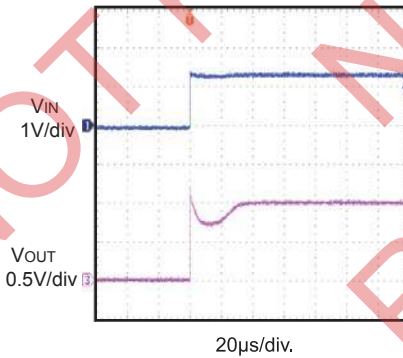
V_{OUT} vs. Temperature

V_{OUT} vs. I_{IN}

I_{IN} vs. V_{OUT}

Turn On With Load Capacitor
 $I_{IN} = 5mA, I_{OUT} = 2mA, C_{OUT} = 4.7\mu F$

Turn Off With Load Capacitor
 $I_{IN} = 5mA, I_{OUT} = 2mA, C_{OUT} = 4.7\mu F$

Line Transient
 $V_{IN} = 3V \text{ to } 6V, I_{IN} = 0.5mA \text{ to } 1mA$

Turn On Time
 $V_{IN} = 1.3V, I_{IN} = 0.5mA$

FUNCTION BLOCK DIAGRAM

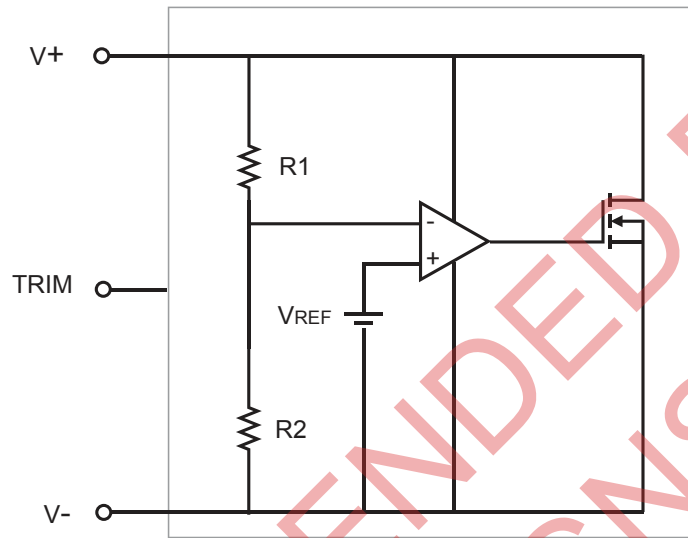

Figure 1—Functional Block Diagram

NOT RECOMMENDED FOR NEW DESIGNS REFER TO MP8201

APPLICATION INFORMATION

External Bias Resistor

In the case of shunt voltage references, an external bias resistor (R_{BIAS}) is required between the supply voltage and the MP8200. R_{BIAS} sets the current that is required to pass through the load and the IC.

The load and supply voltages can vary, so R_{BIAS} should be chosen such that it is small enough to supply the minimum current to the MP8200 when the supply voltage is at its minimum and the load current is at its maximum. In addition, R_{BIAS} needs to be large enough that the quiescent current does not exceed 10mA when the supply voltage is at its maximum and the load current is at its minimum.

Choose R_{BIAS} using the following equation:

$$R_{BIAS} = \frac{V_{SUPPLY} - V_{OUT}}{I_L + I_Q}$$

Adjustable Precision Voltage Source

The MP8200 can be combined with a precision op amp to produce a precise adjustable output voltage. See Figure 1.

The output of the op amp is determined by the gain of the circuit using the following equation:

$$V_{OUT} = 1 + \frac{R1}{R2}$$

An optional capacitor can be added in parallel with $R2$ to filter out high frequency noise.

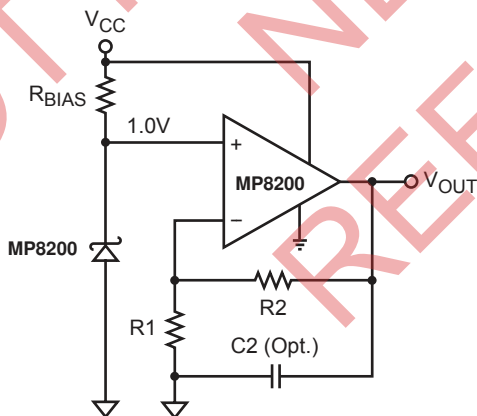

Figure 1—Adjustable Precision Voltage Source

Output Voltage Trim

Using a mechanical or digital potentiometer, the output voltage of the MP8200 can be trimmed to $\pm 0.5\%$. See Figure 2. Note that trimming other resistor values may not produce an accurate output from the MP8200.

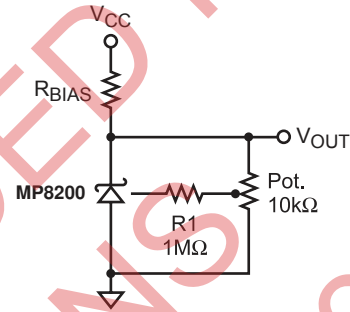

Figure 2—Output Voltage Trim

Precise Negative Voltage Reference

The MP8200 can be configured for use in applications where a precise negative voltage reference is needed.

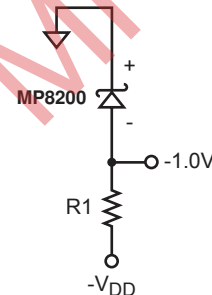

Figure 3—Precise -1.0V Reference

Choose $R1$ such that 100 μ A to 10mA is provided to properly bias the MP8200, using the equation:

$$R1 = \frac{V_{DD}}{I}$$

PACKAGE INFORMATION

SOT23-3

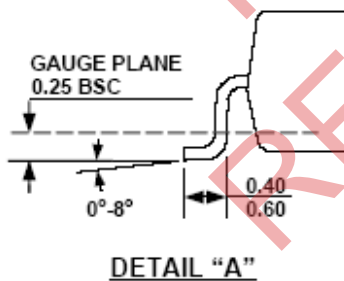
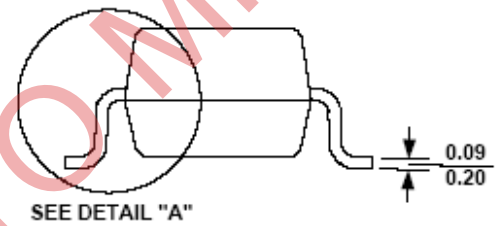
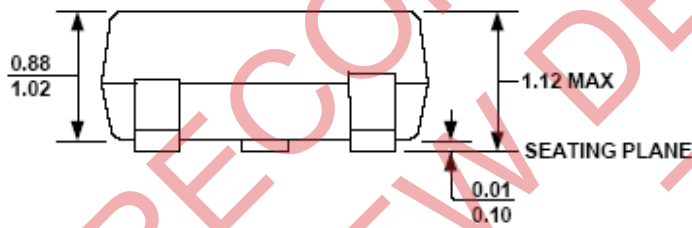
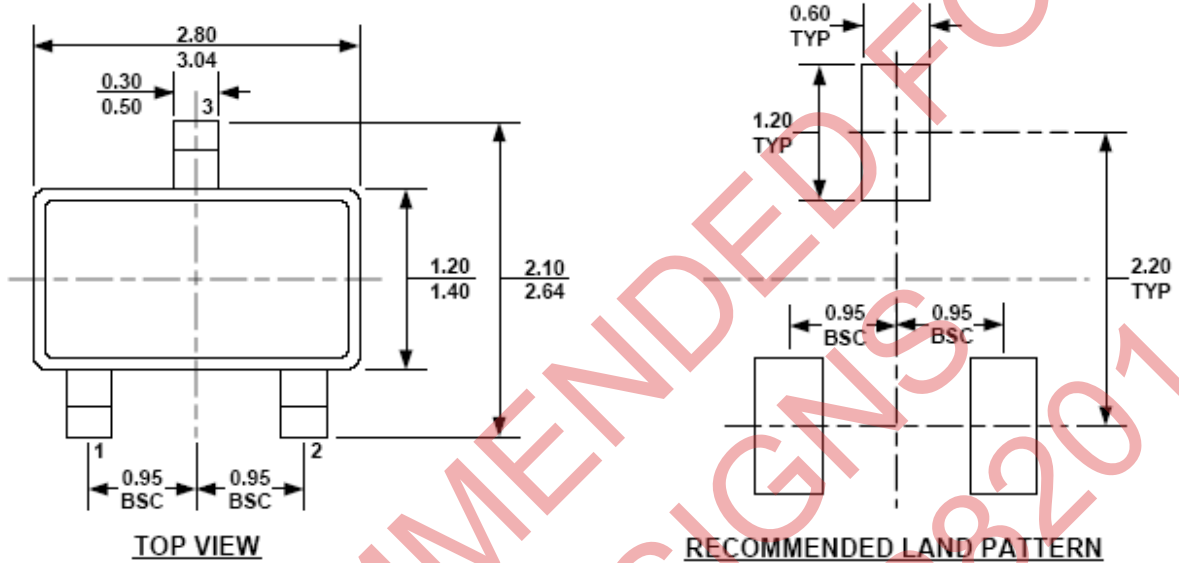
NOTE:

- 1) ALL DIMENSIONS ARE IN MILLIMETERS.
- 2) PACKAGE LENGTH DOES NOT INCLUDE MOLD FLASH, PROTRUSION OR GATE BURR.
- 3) PACKAGE WIDTH DOES NOT INCLUDE INTERLEAD FLASH OR PROTRUSION.
- 4) LEAD COPLANARITY (BOTTOM OF LEADS AFTER FORMING) SHALL BE 0.10 MILLIMETERS MAX.
- 5) DRAWING CONFORMS TO JEDEC TO-236, VARIATION AB.
- 6) DRAWING IS NOT TO SCALE.

NOTICE: The information in this document is subject to change without notice. Users should warrant and guarantee that third party Intellectual Property rights are not infringed upon when integrating MPS products into any application. MPS will not assume any legal responsibility for any said applications.