

Optocoupler, Phototriac Output, Low Input Current

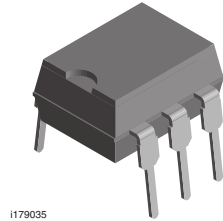

I179035

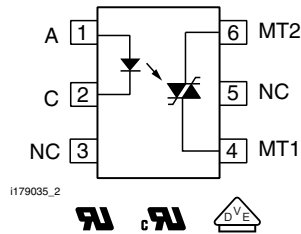

DESCRIPTION

The IL440 consists of a GaAs infrared emitter optically coupled to a silicon planar triac chip with a non-zero crossing network. The two semiconductors are assembled in a 6 pin dual-in-line plastic package. The IL440 can handle currents up to 100 mA RMS.

AGENCY APPROVALS

- UL1577, file no. E52744 system code H or J, double protection
- CSA 93751
- DIN EN 60747-5-5 (VDE 0884) available with option 1
- BSI IEC60950; IEC60065

FEATURES

- 400 V blocking voltage
- 5 mA maximum trigger current
- Isolation test voltage, 5300 V_{RMS}, t = 1 s
- Isolation materials per UL94
- Pin compatible with optocouplers:
 - IL440-4 MOC 3021
 - IL440-5 MOC 3022
 - IL440-6 MOC 3023
- Compliant to RoHS Directive 2002/95/EC and in accordance to WEEE 2002/96/EC

RoHS
COMPLIANT

APPLICATIONS

- High current triac driver
- Solid state relay
- Switch small AC loads

ORDERING INFORMATION

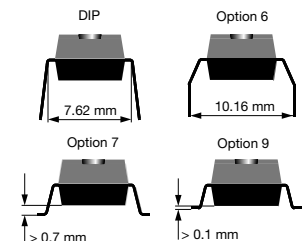
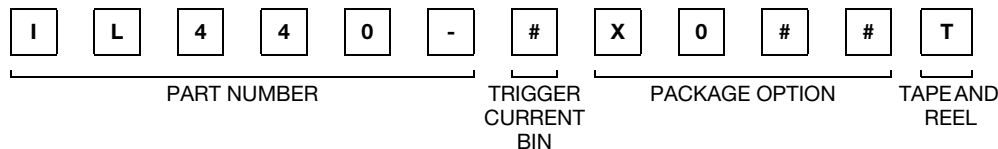

AGENCY CERTIFIED/PACKAGE	TRIGGER CURRENT, I _{FT}		
	5 mA	10 mA	15 mA
UL, cUL, BSI			
DIP-6	IL440-6	IL440-5	IL440-4
SMD-6, option 7	IL440-6X007	-	-
SMD-6, option 9	IL440-6X009T ⁽¹⁾	IL440-5X009	IL440-4X009T ⁽¹⁾
VDE, UL, cUL, BSI			
DIP-6, 400 mil, option 6	IL440-6X016	IL440-5X016	-
SMD-6, option 7	-	IL440-5X017T	IL440-4X017
SMD-6, option 9	IL440-6X019T	-	-

Note

⁽¹⁾ Also available in tubes, do not put T on the end.

Vishay Semiconductors Optocoupler, Phototriac Output, Low Input Current

ABSOLUTE MAXIMUM RATINGS ⁽¹⁾ ($T_{amb} = 25\text{ }^{\circ}\text{C}$, unless otherwise specified)					
PARAMETER	TEST CONDITION	PART	SYMBOL	VALUE	UNIT
Input					
Reverse voltage			V_R	5	V
Forward current			I_F	60	mA
Surge current	P.W. < 10 μs		I_{FSM}	3	A
Power dissipation			P_{diss}	100	mW
Junction temperature			T_j	100	$^{\circ}\text{C}$
Output					
Peak off-state voltage		IL440-4	V_{DRM}	400	V
		IL440-5	V_{DRM}	400	V
		IL440-6	V_{DRM}	400	V
On-state RMS current			$I_{D(RMS)}$	100	mA
Peak surge current	$t_p \leq 10\text{ ms}$		I_{FSM}	1.2	A
Peak on-state current	$t_p/T = 0.01 \leq 100\text{ }\mu\text{s}$		I_{DRM}	2	A
Power dissipation			P_{diss}	300	mW
Junction temperature			T_j	125	$^{\circ}\text{C}$
Coupler					
Isolation voltage	$t = 1\text{ s}$		V_{ISO}	5300	V_{RMS}
Creepage distance				≥ 7	mm
Clearance distance				≥ 7	mm
Isolation resistance	$V_{IO} = 500\text{ V}, T_{amb} = 25\text{ }^{\circ}\text{C}$		R_{IO}	$\geq 10^{12}$	Ω
	$V_{IO} = 500\text{ V}, T_{amb} = 100\text{ }^{\circ}\text{C}$		R_{IO}	$\geq 10^{11}$	Ω
Total power dissipation			P_{tot}	330	mW
Storage temperature range			T_{stg}	- 55 to + 125	$^{\circ}\text{C}$
Ambient temperature			T_{amb}	- 40 to + 100	$^{\circ}\text{C}$
Junction temperature			T_j	100	$^{\circ}\text{C}$
Lead soldering temperature ⁽²⁾	2 mm from case, $t < 10\text{ s}$		T_{slid}	260	$^{\circ}\text{C}$

Notes

⁽¹⁾ Stresses in excess of the absolute maximum ratings can cause permanent damage to the device. Functional operation of the device is not implied at these or any other conditions in excess of those given in the operational sections of this document. Exposure to absolute maximum ratings for extended periods of the time can adversely affect reliability.

⁽²⁾ Refer to reflow profile for soldering conditions for surface mounted devices (SMD). Refer to wave profile for soldering conditions for through hole devices (DIP).



Optocoupler, Phototriac Output, Low Input Current Vishay Semiconductors

ELECTRICAL CHARACTERISTICS ⁽¹⁾ ($T_{amb} = 25\text{ }^{\circ}\text{C}$, unless otherwise specified)							
PARAMETER	TEST CONDITION	PART	SYMBOL	MIN.	TYP.	MAX.	UNIT
Input							
Forward voltage	$I_F = 50\text{ mA}$		V_F		1.25		V
Reverse voltage	$I_R = 10\text{ }\mu\text{A}$		V_R	5			V
Junction capacitance	$V_R = 0\text{ V}$, $f = 1\text{ MHz}$		C_j		50		pF
Output ⁽²⁾							
Off-state voltage	$I_{DRM} = 500\text{ nA}$	IL440-4	$V_{D(RMS)}$	400			V
		IL440-5		400			V
		IL440-6		400			V
Peak on-state voltage	$I_{TM} = 100\text{ mA}$, $I_{FT} = 30\text{ mA}$		V_{TM}		1.5	3	V
Trigger current 1	$V_T = 6\text{ V}$, $R_L = 150\text{ }\Omega$	IL440-4	I_{FT1}		15		V
Trigger current 2		IL440-5	I_{FT2}		10		V
Trigger current 3		IL440-6	I_{FT3}		5		V
Critical rate of rise of off-state voltage	$I_F = 0$, $V_D = 0.67\text{ }V_{DRM}$		dV/dt_{cr}		50		V/ μs
Critical rate of rise of on-state current commutation	$I_F = 30\text{ mA}$, $V_D = 60\text{ }V_{RMS}$		dV/dt_{crq}	0.13	0.25		V/ μs
Coupler							
Holding current	$I_F \geq 10\text{ mA}$, $V_S \geq 3\text{ V}$		I_H		1		mA

Notes

- (1) Minimum and maximum values are testing requirements. Typical values are characteristics of the device and are the result of engineering evaluation. Typical values are for information only and are not part of the testing requirements.
- (2) Off-state output terminal voltage (see table 1.)

MAXIMUM SAFETY RATINGS ⁽¹⁾						
PARAMETER	TEST CONDITION	SYMBOL	MIN.	TYP.	MAX.	UNIT
INPUT ⁽²⁾						
Forward voltage		$I_{S, INPUT}$			130	mA
OUTPUT						
Power dissipation		$P_{S, OUTPUT}$			300	mW

Notes

- (1) According to DIN EN 60747-5-5. This optocoupler is suitable for safe electrical isolation only within the safety ratings. Compliance with the safety ratings shall be ensured by means of suitable protective circuits.
- (2) The device is used for protective separation against electrical shock within the maximum safety ratings. This must be ensured by protective circuits in the applications.

SAFETY AND INSULATION RATINGS						
PARAMETER	TEST CONDITION	SYMBOL	MIN.	TYP.	MAX.	UNIT
Climatic classification (according to IEC68 part 1)				55/100/21		
Pollution degree	DIN VDE 0109			2		
Comparative tracking index		CTI	175			
V_{IOTM}			8000			V_{peak}
V_{IORM}			890			V_{peak}
Insulation resistance at 25 °C	$V_{IO} = 500\text{ V}$	R_{IS}			$\geq 10^{12}$	Ω
Insulation resistance at T_S	$V_{IO} = 500\text{ V}$	R_{IS}			$\geq 10^9$	Ω
Insulation resistance at 100 °C	$V_{IO} = 500\text{ V}$	R_{IS}			$\geq 10^{11}$	Ω
Partial discharge test voltage	Method a, $V_{pd} = V_{IORM} \times 1.875$	V_{pd}			1669	V_{peak}
P_{SO}					500	mW
I_{SI}					250	mA
T_{SI}					175	$^{\circ}\text{C}$

Vishay Semiconductors Optocoupler, Phototriac Output, Low Input Current

SAFETY AND INSULATION RATINGS						
PARAMETER	TEST CONDITION	SYMBOL	MIN.	TYP.	MAX.	UNIT
Clearance distance	Standard DIP-6		7			mm
Creepage distance	Standard DIP-6		7			mm
Clearance distance	400 mil DIP-6		8			mm
Creepage distance	400 mil DIP-6		8			mm

Note

- As per IEC60747-5-5, § 7.4.3.8.1, this optocoupler is suitable for "safe electrical insulation" only within the safety ratings. Compliance with the safety ratings shall be ensured by means of protective circuits.

PACKAGE DIMENSIONS in millimeters

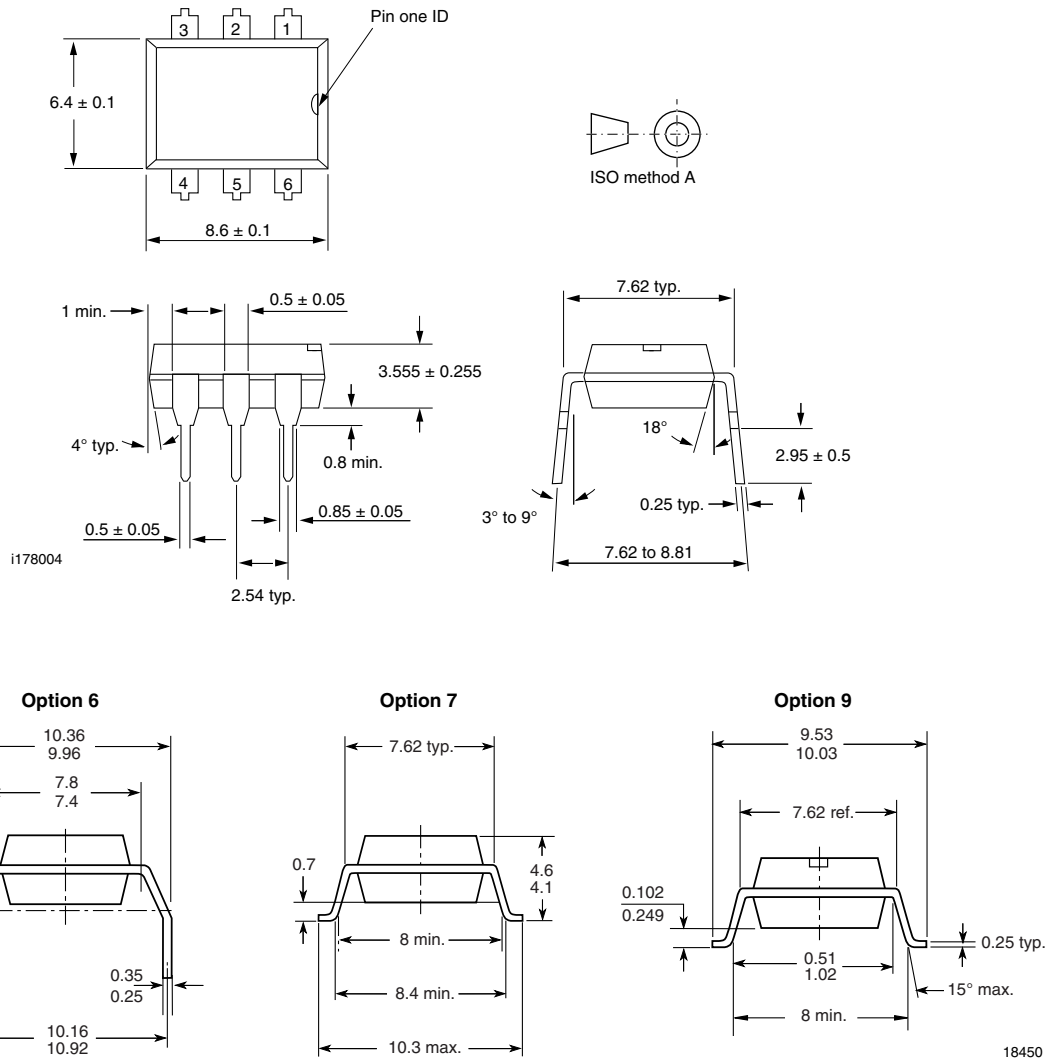

PACKAGE MARKING

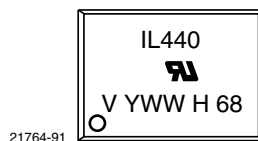

21764-91



DIP-6A

Package Dimensions in Inches (mm)

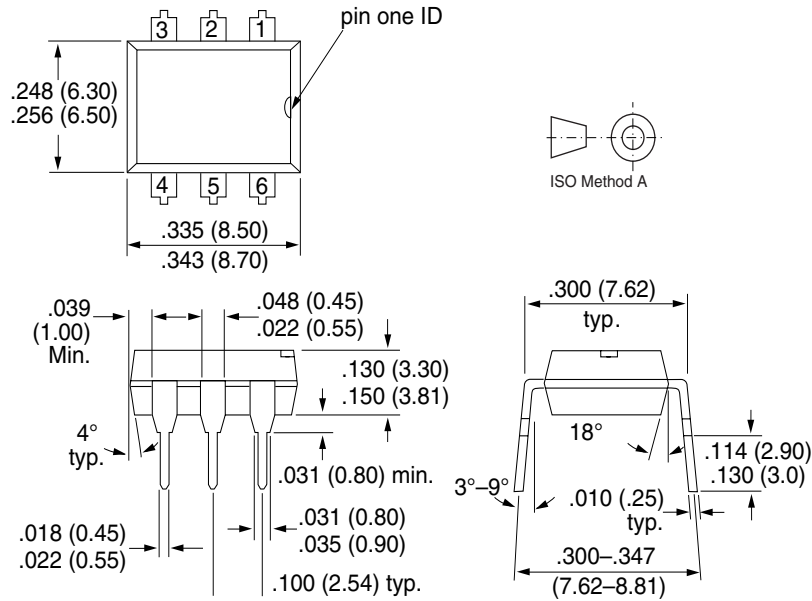

i178004

Ozone Depleting Substances Policy Statement

It is the policy of **Vishay Semiconductor GmbH** to

1. Meet all present and future national and international statutory requirements.
2. Regularly and continuously improve the performance of our products, processes, distribution and operating systems with respect to their impact on the health and safety of our employees and the public, as well as their impact on the environment.

It is particular concern to control or eliminate releases of those substances into the atmosphere which are known as ozone depleting substances (ODSs).

The Montreal Protocol (1987) and its London Amendments (1990) intend to severely restrict the use of ODSs and forbid their use within the next ten years. Various national and international initiatives are pressing for an earlier ban on these substances.

Vishay Semiconductor GmbH has been able to use its policy of continuous improvements to eliminate the use of ODSs listed in the following documents.

1. Annex A, B and list of transitional substances of the Montreal Protocol and the London Amendments respectively
2. Class I and II ozone depleting substances in the Clean Air Act Amendments of 1990 by the Environmental Protection Agency (EPA) in the USA
3. Council Decision 88/540/EEC and 91/690/EEC Annex A, B and C (transitional substances) respectively.

Vishay Semiconductor GmbH can certify that our semiconductors are not manufactured with ozone depleting substances and do not contain such substances.

**We reserve the right to make changes to improve technical design
and may do so without further notice.**

Parameters can vary in different applications. All operating parameters must be validated for each customer application by the customer. Should the buyer use Vishay Semiconductors products for any unintended or unauthorized application, the buyer shall indemnify Vishay Semiconductors against all claims, costs, damages, and expenses, arising out of, directly or indirectly, any claim of personal damage, injury or death associated with such unintended or unauthorized use.

Vishay Semiconductor GmbH, P.O.B. 3535, D-74025 Heilbronn, Germany
Telephone: 49 (0)7131 67 2831, Fax number: 49 (0)7131 67 2423

Footprints

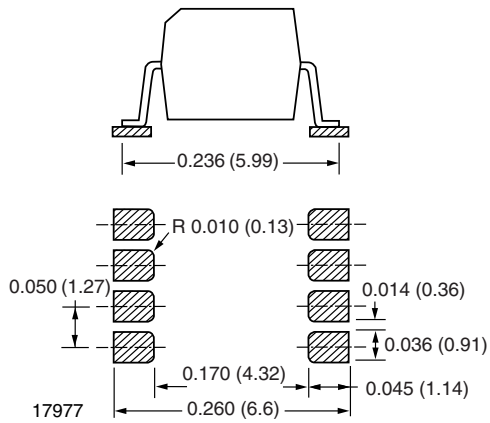
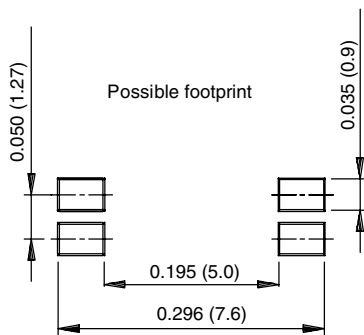
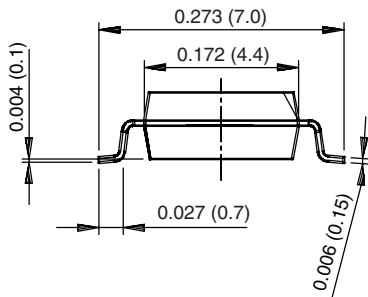
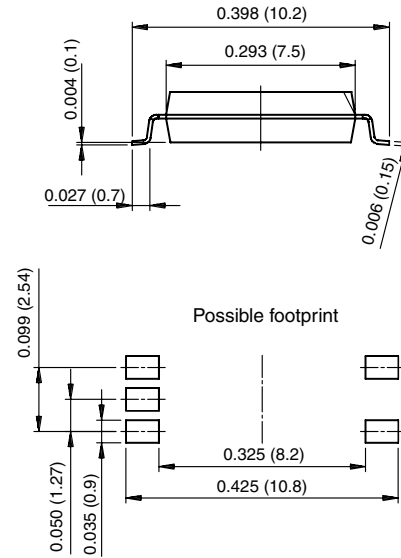

Fig. 1 - SO8A and DSO8A SMD



18403

Fig. 2 - SOP-4, Miniflat



18406

Fig. 3 - SOP-6, 5 Pin Wide Body

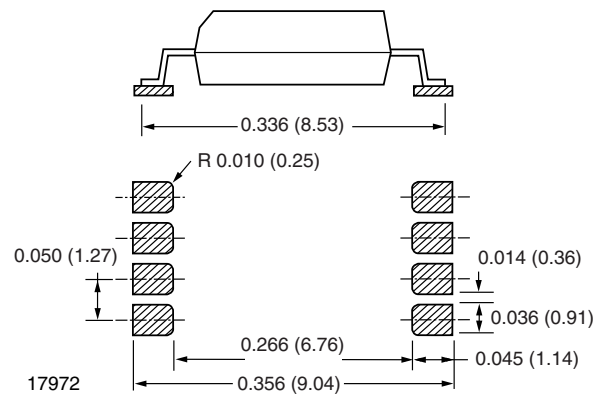

Fig. 4 - 8 Pin PCMCIA

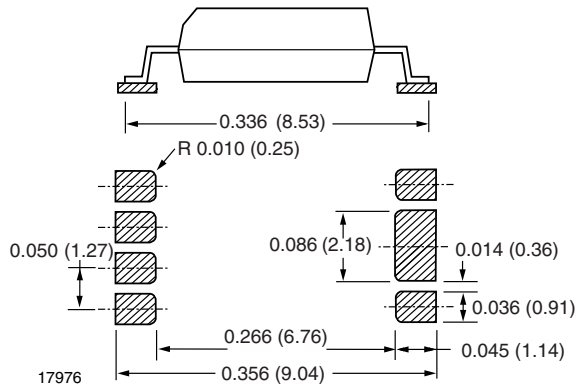

Fig. 5 - 8 Pin PCMCIA, Heat Sink

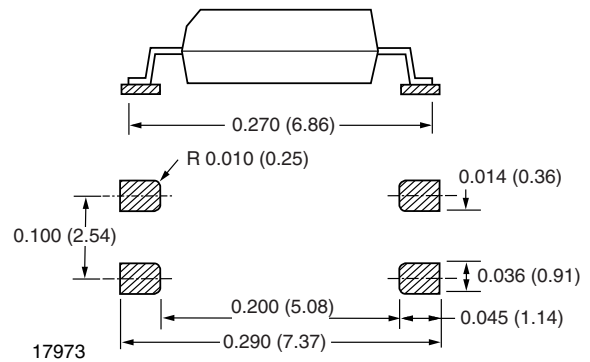

Fig. 8 - 4 Pin Mini-Flat

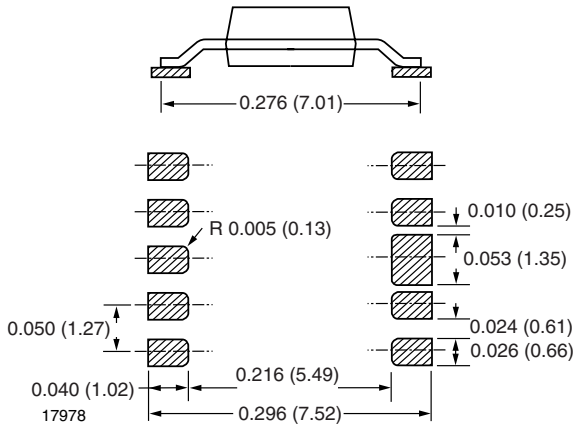

Fig. 6 - Mini Coupler

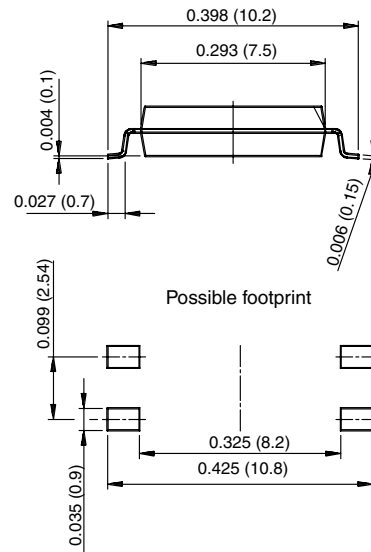

Fig. 9 - SOP-6, 4 Pin Wide Body

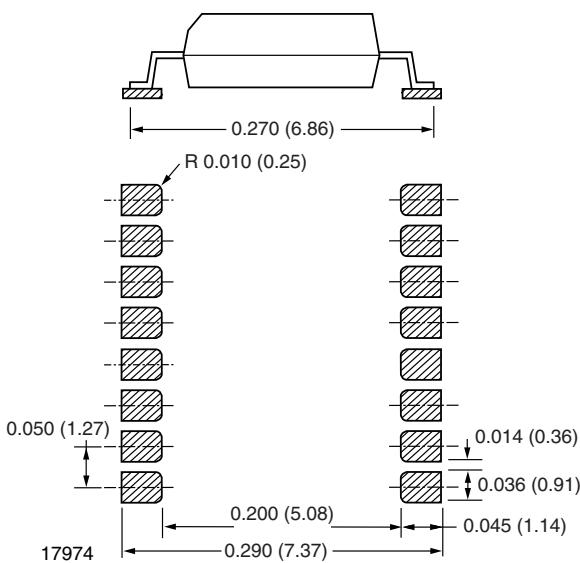

Fig. 7 - SOP-16

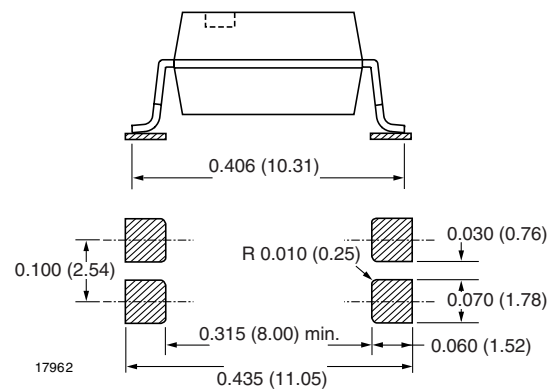

Fig. 10 - 4 Pin SMD Option 7

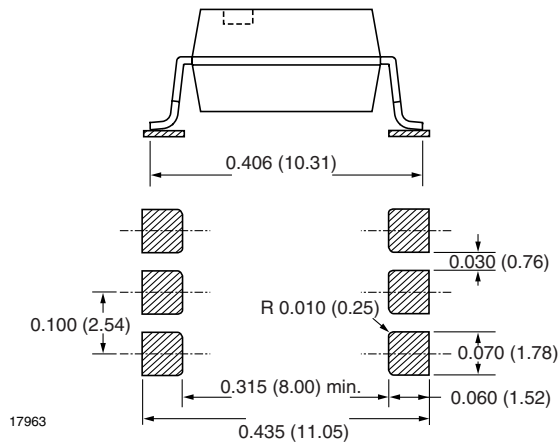

Fig. 11 - 6 Pin SMD Option 7

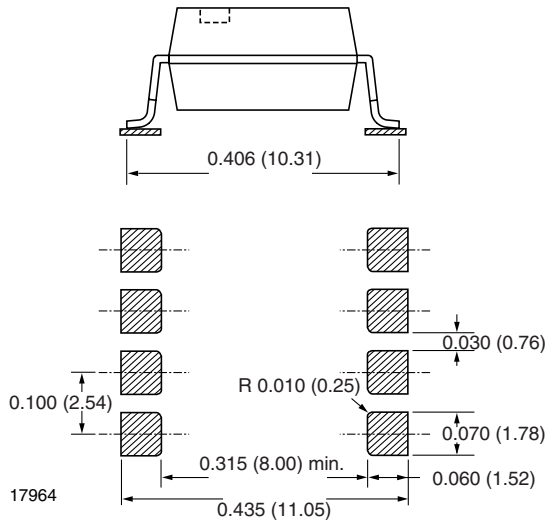

Fig. 12 - 8 Pin SMD Option 7

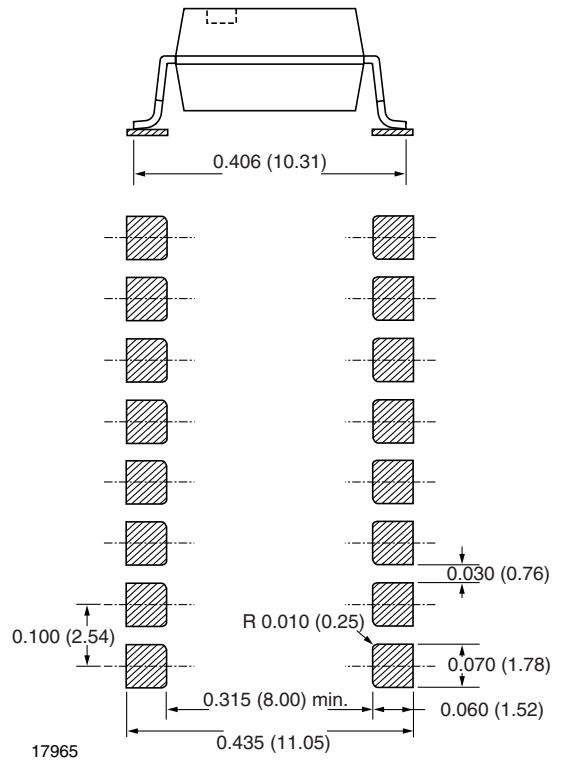

Fig. 13 - 16 Pin SMD Option 7

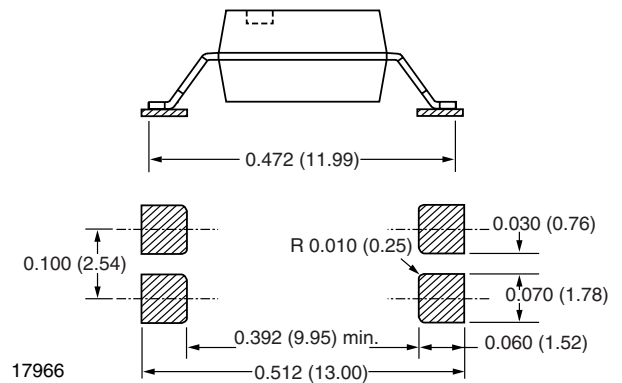

Fig. 14 - 4 Pin SMD Option 8

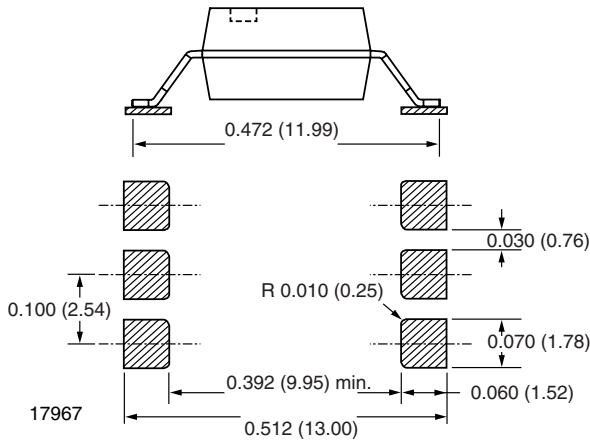

Fig. 15 - 6 Pin SMD Option 8

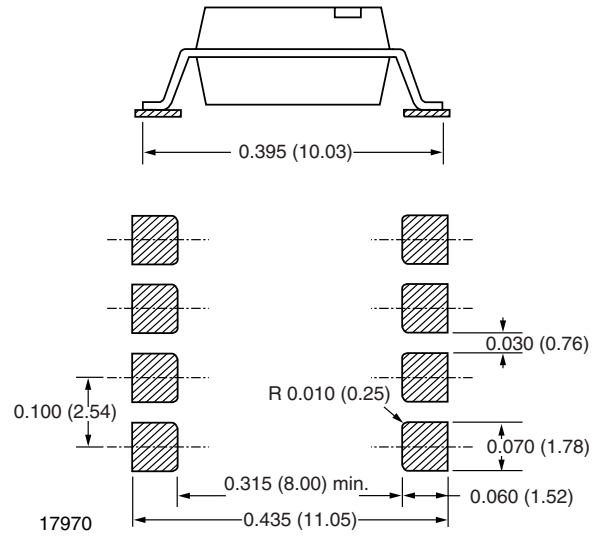

Fig. 18 - 8 Pin SMD Option 9

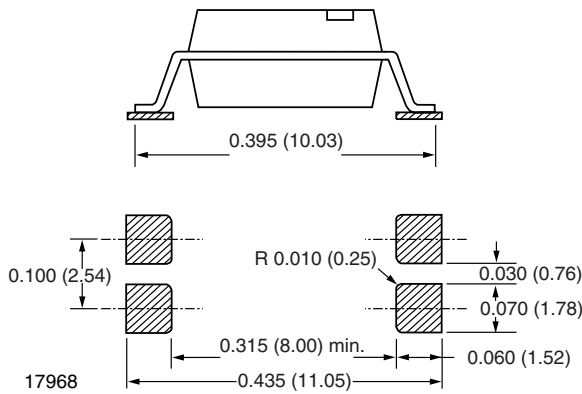

Fig. 16 - 4 Pin SMD Option 9

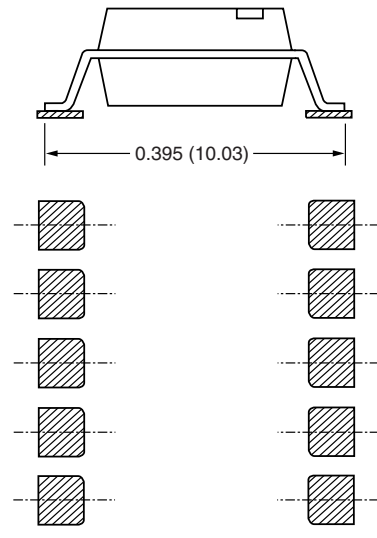

Fig. 19 - 16 Pin SMD Option 9

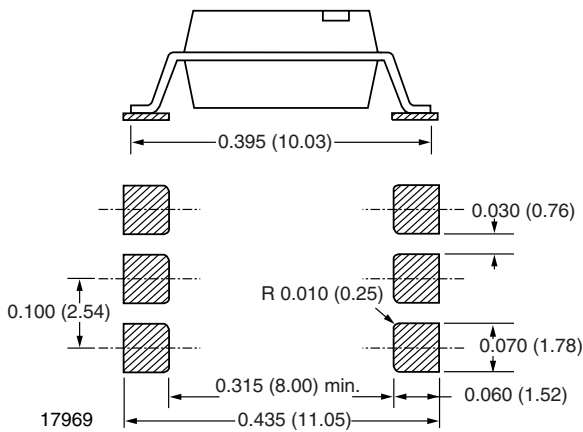

Fig. 17 - 6 Pin SMD Option 9

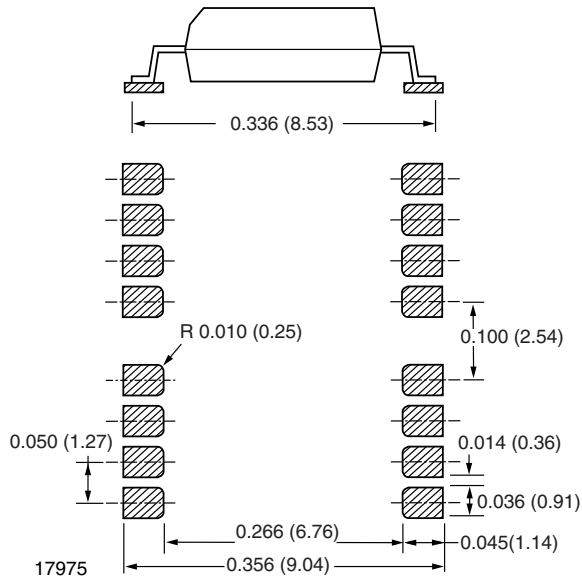

Fig. 20 - 16 Pin PCMCIA



Disclaimer

ALL PRODUCT, PRODUCT SPECIFICATIONS AND DATA ARE SUBJECT TO CHANGE WITHOUT NOTICE TO IMPROVE RELIABILITY, FUNCTION OR DESIGN OR OTHERWISE.

Vishay Intertechnology, Inc., its affiliates, agents, and employees, and all persons acting on its or their behalf (collectively, "Vishay"), disclaim any and all liability for any errors, inaccuracies or incompleteness contained in any datasheet or in any other disclosure relating to any product.

Vishay makes no warranty, representation or guarantee regarding the suitability of the products for any particular purpose or the continuing production of any product. To the maximum extent permitted by applicable law, Vishay disclaims (i) any and all liability arising out of the application or use of any product, (ii) any and all liability, including without limitation special, consequential or incidental damages, and (iii) any and all implied warranties, including warranties of fitness for particular purpose, non-infringement and merchantability.

Statements regarding the suitability of products for certain types of applications are based on Vishay's knowledge of typical requirements that are often placed on Vishay products in generic applications. Such statements are not binding statements about the suitability of products for a particular application. It is the customer's responsibility to validate that a particular product with the properties described in the product specification is suitable for use in a particular application. Parameters provided in datasheets and/or specifications may vary in different applications and performance may vary over time. All operating parameters, including typical parameters, must be validated for each customer application by the customer's technical experts. Product specifications do not expand or otherwise modify Vishay's terms and conditions of purchase, including but not limited to the warranty expressed therein.

Except as expressly indicated in writing, Vishay products are not designed for use in medical, life-saving, or life-sustaining applications or for any other application in which the failure of the Vishay product could result in personal injury or death. Customers using or selling Vishay products not expressly indicated for use in such applications do so at their own risk and agree to fully indemnify and hold Vishay and its distributors harmless from and against any and all claims, liabilities, expenses and damages arising or resulting in connection with such use or sale, including attorneys fees, even if such claim alleges that Vishay or its distributor was negligent regarding the design or manufacture of the part. Please contact authorized Vishay personnel to obtain written terms and conditions regarding products designed for such applications.

No license, express or implied, by estoppel or otherwise, to any intellectual property rights is granted by this document or by any conduct of Vishay. Product names and markings noted herein may be trademarks of their respective owners.