

ORDER NO.	WOODHEAD NO.	COLOR
130146-0082	24W47	YELLOW
130146-0083	24W47BLK	BLACK

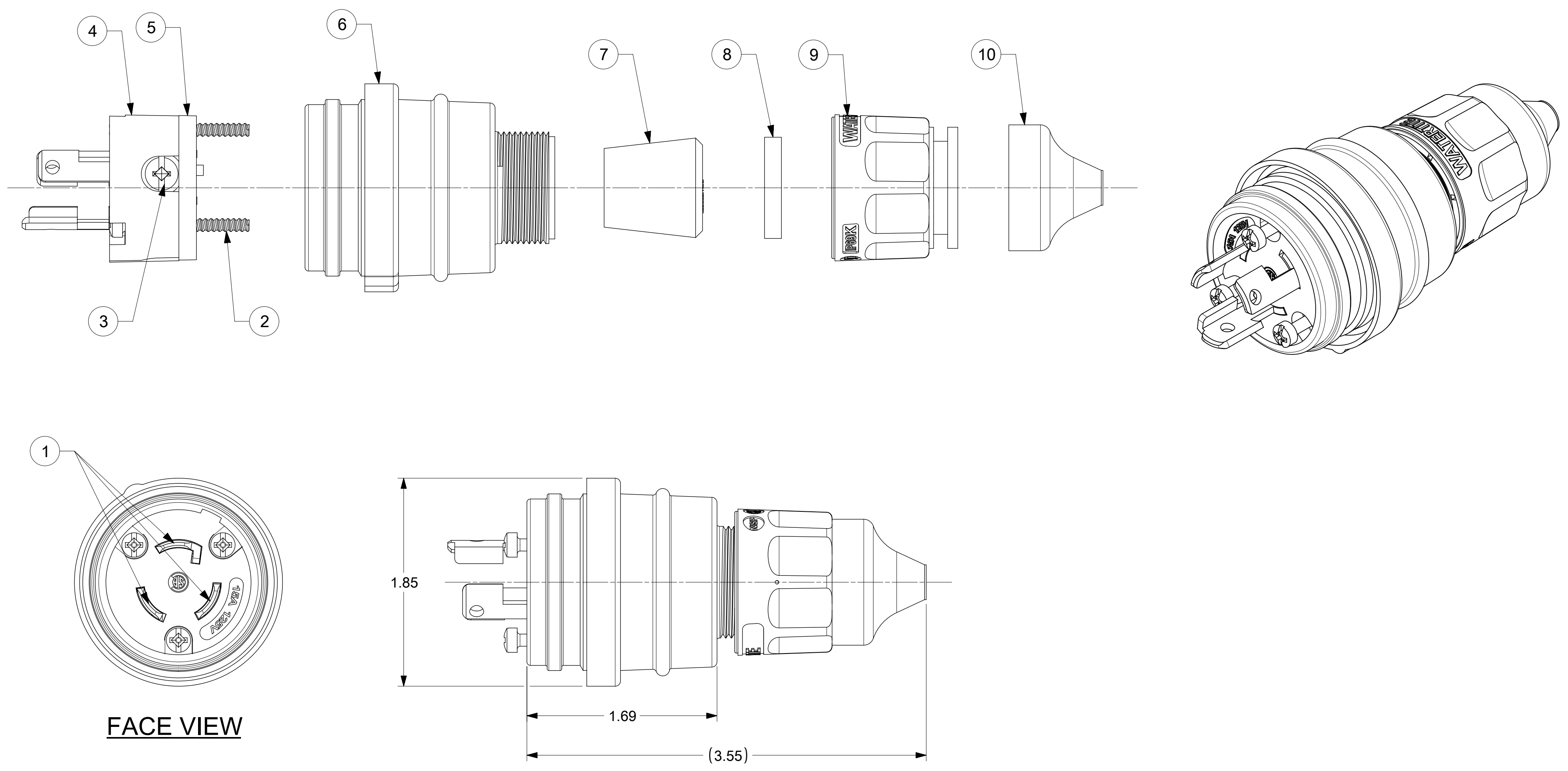

ITEM NO.	DESCRIPTIONS	MATERIAL	QTY.
1	BLADES	BRASS	3
2	RETAINING SCREWS	STAINLESS STEEL	3
3	TERMINAL SCREWS	BRASS, ZINC PLATED	3
4	INSERT	NYLON	1
5	TERMINAL COVER	POLYCARBONATE	1
6	HOUSING	SILICONE WITH NYLON THREAD	1
7	GROMMETS	RUBBER	5
8	FRICTION RING	NYLON	1
9	COMPRESSION NUT	NYLON	1
10	CABLE GLOVE	SILICONE	1

NOTES:
 1. SEE INSTRUCTION SHEET NUMBER 1301414770 FOR PRODUCT SPECIFICATION.
 2. CABLE RANGE FROM 0.375" TO 0.625"

SYMBOLS		THIS DRAWING CONTAINS INFORMATION THAT IS PROPRIETARY TO MOLEX ELECTRONIC TECHNOLOGIES, LLC AND SHOULD NOT BE USED WITHOUT WRITTEN PERMISSION	
▽ = 0	DIMENSION UNITS	SCALE	CURRENT REV DESC: RELEASED
▽ = 0	INCH	NTS	
▽ = 0	GENERAL TOLERANCES (UNLESS SPECIFIED)		
▽ = 0	ANGULAR TOL	± 0.5°	
▽ = 0	4 PLACES	±	EC NO: 613699
▽ = 0	3 PLACES	± 0.005	DRWN: VHANDI 2019/03/13
▽ = 0	2 PLACES	± 0.01	CHK'D: DNGUYEN62 2019/03/18
▽ = 0	1 PLACE	± 0.02	APPR: HKNEELAND 2019/03/21
▽ = 0	0 PLACES	±	INITIAL REVISION:
▽ = 0	DRAFT WHERE APPLICABLE MUST REMAIN WITHIN DIMENSIONS		DRWN: NVELUSAMY 2018/11/08
▽ = 0	THIRD ANGLE PROJECTION		APPR: HKNEELAND 2019/02/26
	DRAWING	SERIES	DOCUMENT NUMBER
	C-SIZE	130146	1301460082
	MATERIAL NUMBER	CUSTOMER	DOC TYPE DOC PART REVISION
	SEE TABLE	GENERAL MARKET	PSD 000 A1
	SHEET NUMBER		1 OF 1