



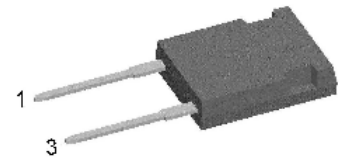
# HiPerDynFRED

$V_{RRM}$	=	600 V
$I_{FAV}$	=	30 A
$t_{rr}$	=	35 ns

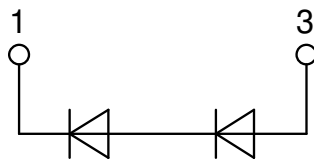
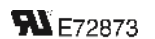
High Performance Dynamic Fast Recovery Diode  
Extreme Low Loss and Soft Recovery  
Single Diode

Part number

**DPH30IS600HI**



Backside: isolated



### Features / Advantages:

- Planar passivated chips
- Very low leakage current
- Very short recovery time
- Improved thermal behaviour
- Very low  $I_{rm}$ -values
- Very soft recovery behaviour
- Avalanche voltage rated for reliable operation
- Soft reverse recovery for low EMI/RFI
- Low  $I_{rm}$  reduces:
  - Power dissipation within the diode
  - Turn-on loss in the commutating switch

### Applications:

- Antiparallel diode for high frequency switching devices
- Antisaturation diode
- Snubber diode
- Free wheeling diode
- Rectifiers in switch mode power supplies (SMPS)
- Uninterruptible power supplies (UPS)

### Package: ISOPLUS247

- Isolation Voltage: 3600 V~
- Industry standard outline
- RoHS compliant
- Epoxy meets UL 94V-0
- Soldering pins for PCB mounting
- Backside: DCB ceramic
- Reduced weight
- Advanced power cycling

### Disclaimer Notice

Information furnished is believed to be accurate and reliable. However, users should independently evaluate the suitability of and test each product selected for their own applications. Littelfuse products are not designed for, and may not be used in, all applications. Read complete Disclaimer Notice at [www.littelfuse.com/disclaimer-electronics](http://www.littelfuse.com/disclaimer-electronics).

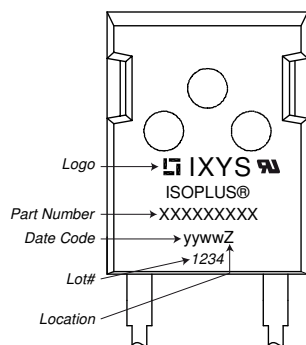


Fast Diode				Ratings			
Symbol	Definition	Conditions	min.	typ.	max.	Unit	
$V_{RSM}$	max. non-repetitive reverse blocking voltage	$T_{VJ} = 25^{\circ}C$			600	V	
$V_{RRM}$	max. repetitive reverse blocking voltage	$T_{VJ} = 25^{\circ}C$			600	V	
$I_R$	reverse current, drain current	$V_R = 600 V$	$T_{VJ} = 25^{\circ}C$		1	$\mu A$	
		$V_R = 600 V$	$T_{VJ} = 150^{\circ}C$		0.2	mA	
$V_F$	forward voltage drop	$I_F = 30 A$	$T_{VJ} = 25^{\circ}C$		2.48	V	
		$I_F = 60 A$			3.02	V	
		$I_F = 30 A$	$T_{VJ} = 150^{\circ}C$		1.89	V	
		$I_F = 60 A$			2.45	V	
$I_{FAV}$	average forward current	$T_C = 140^{\circ}C$ rectangular $d = 0.5$	$T_{VJ} = 175^{\circ}C$		30	A	
$V_{FO}$	threshold voltage	} for power loss calculation only	$T_{VJ} = 175^{\circ}C$		1.10	V	
$r_F$	slope resistance				12.6	m $\Omega$	
$R_{thJC}$	thermal resistance junction to case				0.55	K/W	
$R_{thCH}$	thermal resistance case to heatsink			0.3		K/W	
$P_{tot}$	total power dissipation		$T_C = 25^{\circ}C$		285	W	
$I_{FSM}$	max. forward surge current	$t = 10 ms; (50 Hz), sine; V_R = 0 V$	$T_{VJ} = 45^{\circ}C$		450	A	
$C_J$	junction capacitance	$V_R = 400 V$ $f = 1 MHz$	$T_{VJ} = 25^{\circ}C$		30	pF	
$I_{RM}$	max. reverse recovery current	} $I_F = 30 A; V_R = 400 V$ $-di_F / dt = 200 A/\mu s$	$T_{VJ} = 25^{\circ}C$		3	A	
			$T_{VJ} = 125^{\circ}C$		8	A	
$t_{rr}$	reverse recovery time		$T_{VJ} = 25^{\circ}C$		35	ns	
			$T_{VJ} = 125^{\circ}C$		65	ns	



Package ISOPLUS247		Ratings				
Symbol	Definition	Conditions	min.	typ.	max.	Unit
$I_{RMS}$	RMS current	per terminal			70	A
$T_{VJ}$	virtual junction temperature		-55		175	°C
$T_{op}$	operation temperature		-55		150	°C
$T_{stg}$	storage temperature		-55		150	°C
<b>Weight</b>				6		g
$F_C$	mounting force with clip		20		120	N
$d_{Spp/APP}$	creepage distance on surface / striking distance through air	terminal to terminal	5.4			mm
$d_{Spb/APb}$		terminal to backside	4.1			mm
$V_{ISOL}$	isolation voltage	t = 1 second	3600			V
		t = 1 minute	3000			V

**Product Marking**



**Part description**

- D = Diode
- P = HiPerFRED
- H = HiPerDyn
- 30 = Current Rating [A]
- IS = Single Diode
- 600 = Reverse Voltage [V]
- HI = ISOPLUS247 (2)

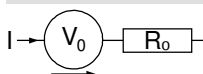
Ordering	Ordering Number	Marking on Product	Delivery Mode	Quantity	Code No.
Standard	DPH30IS600HI	DPH30IS600HI	Tube	30	506235

Similar Part	Package	Voltage class
DHG60I600HA	TO-247AD (2)	600
DSEP60-06A	TO-247AD (2)	600
DSEP60-06AT	TO-268AA (D3Pak) (2)	600

**Equivalent Circuits for Simulation**

\* on die level

$T_{VJ} = 175^{\circ}C$

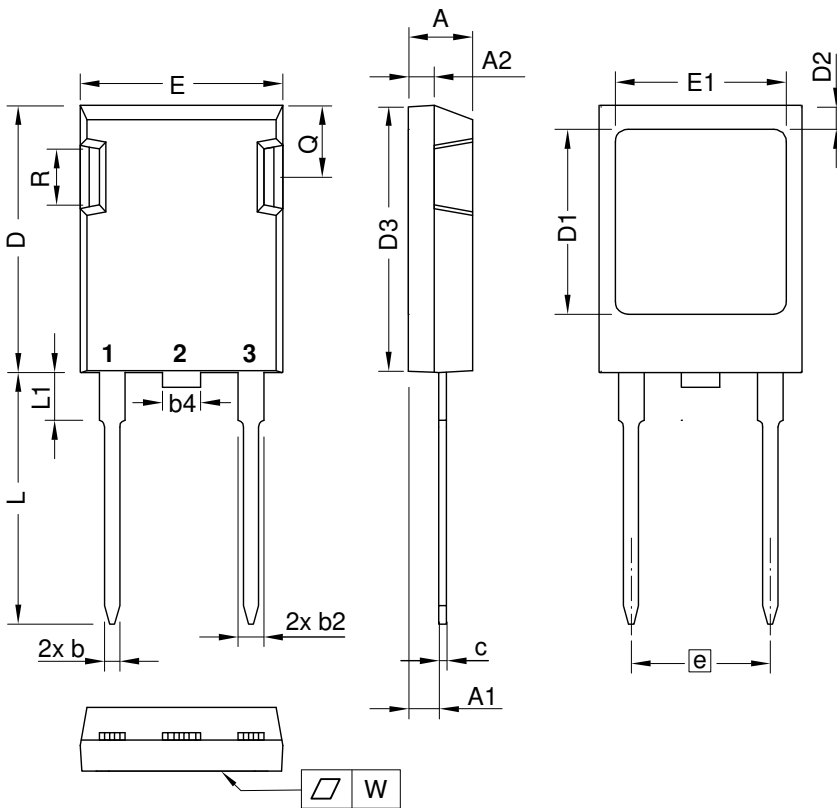


**Fast Diode**

$V_{0\ max}$	threshold voltage	1.1	V
$R_{0\ max}$	slope resistance *	10	mΩ



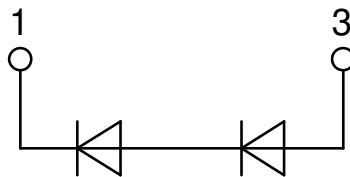
Outlines ISOPLUS247



Dim.	Millimeter		Inches	
	min	max	min	max
A	4.83	5.21	0.190	0.205
A1	2.29	2.54	0.090	0.100
A2	1.91	2.16	0.075	0.085
b	1.14	1.40	0.045	0.055
b2	1.91	2.20	0.075	0.087
b4	2.92	3.24	0.115	0.128
c	0.61	0.83	0.024	0.033
D	20.80	21.34	0.819	0.840
D1	15.75	16.26	0.620	0.640
D2	1.65	2.15	0.065	0.085
D3	20.30	20.70	0.799	0.815
E	15.75	16.13	0.620	0.635
E1	13.21	13.72	0.520	0.540
e	10.90 BSC		0.429 BSC	
L	19.81	20.60	0.780	0.811
L1	3.81	4.38	0.150	0.172
Q	5.59	6.20	0.220	0.244
R	4.25	5.50	0.167	0.217
W	-	0.10	-	0.004

Die konvexe Form des Substrates ist typ. < 0.04 mm über der Kunststoffoberfläche der Bauteilunterseite  
The convex bow of substrate is typ. < 0.04 mm over plastic surface level of device bottom side

Die Gehäuseabmessungen entsprechen dem Typ TO-247 AD gemäß JEDEC außer Schraubloch und  $L_{max}$ .  
This drawing will meet all dimensions requirement of JEDEC outline TO-247 AD except screw hole and except  $L_{max}$ .



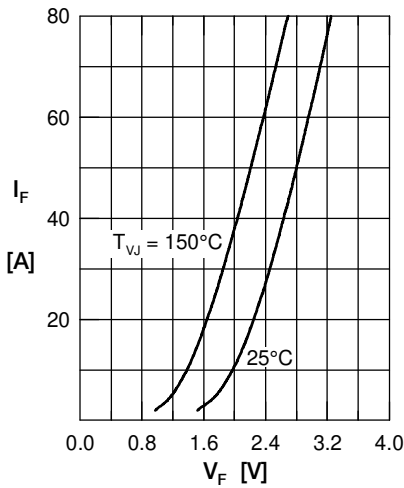
**Fast Diode**


Fig. 1 Forward current  $I_F$  versus  $V_F$

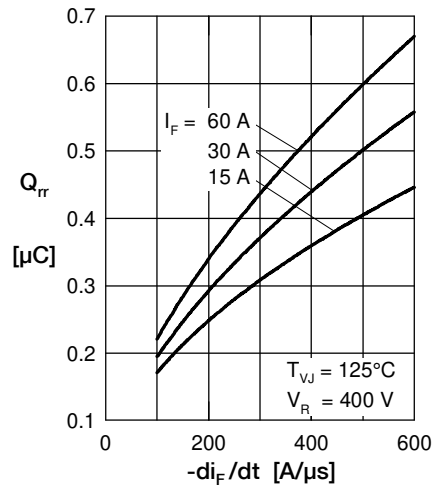


Fig. 2 Typ. reverse recov. charge  $Q_{rr}$  versus  $-di_F/dt$

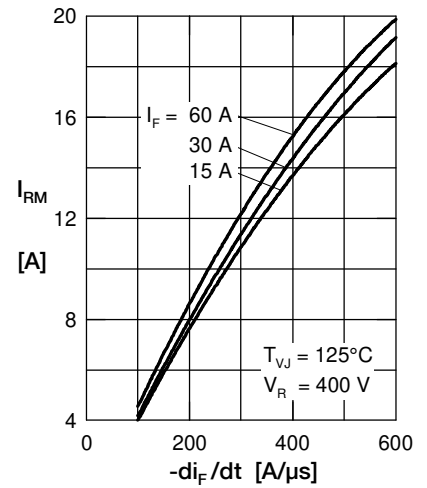


Fig. 3 Typ. reverse recov. current  $I_{RM}$  versus  $-di_F/dt$

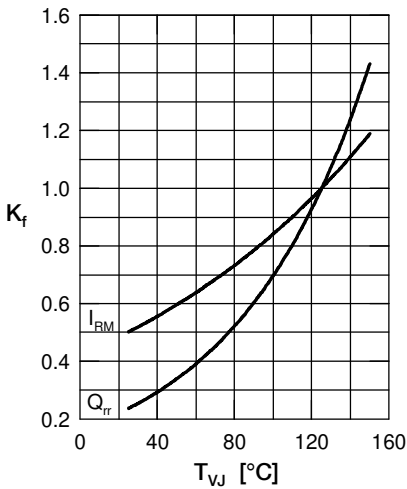


Fig. 4 Typ. dynamic parameters  $Q_{rr}$ ,  $I_{RM}$  versus  $T_{VJ}$

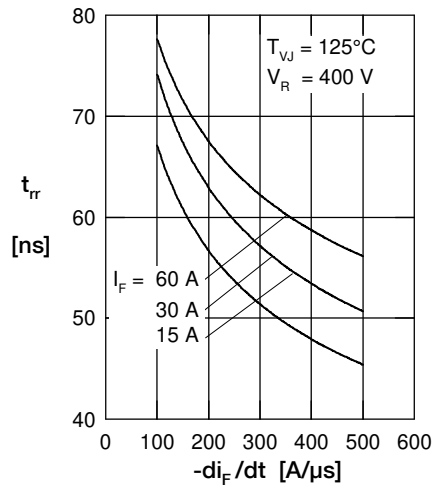


Fig. 5 Typ. reverse recov. time  $t_{tr}$  versus  $-di_F/dt$

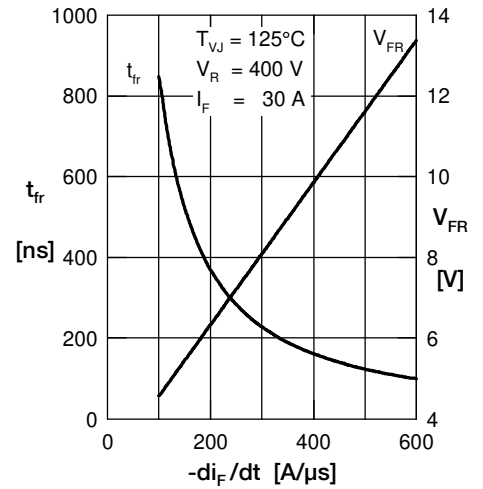


Fig. 6 Typ. forward recov. voltage  $V_{FR}$  & time  $t_{fr}$  versus  $di_F/dt$

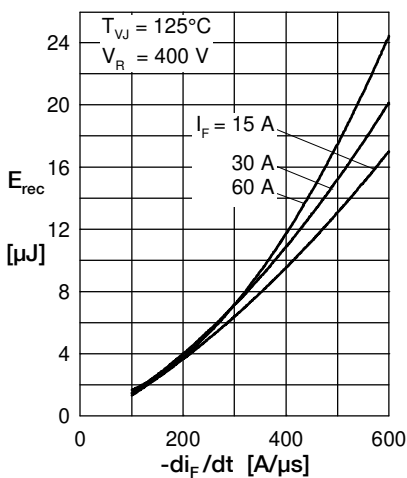


Fig. 7 Typ. recovery energy  $E_{rec}$  versus  $-di_F/dt$

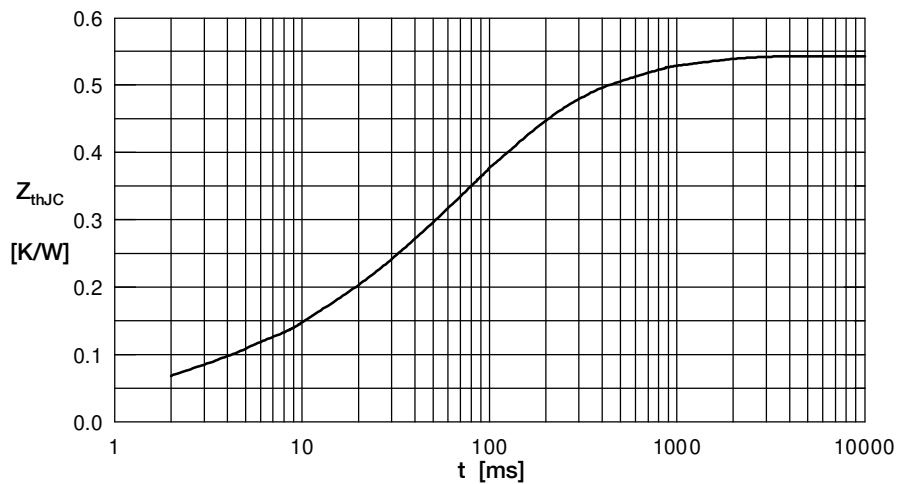


Fig. 8 Transient thermal impedance junction to case