

MAX44264

nanoPower Op Amp in a Tiny 6-Bump WLP

General Description

The MAX44264 is an ultra-small (6-bump WLP) op amp that draws only 750nA of supply current. It operates from a single +1.8V to +5.5V supply and features ground-sensing inputs and rail-to-rail output. The ultralow supply current, low-operating voltage, and rail-to-rail output capabilities make these operational amplifiers ideal for use in single lithium ion (Li+), or two-cell NiCd or alkaline battery systems. The rail-to-rail output stage of the MAX44264 is capable of driving the output voltage to within 4mV of the rail with a 100k Ω load, and can sink and source 11mA with a +5V supply. The IC is unity-gain stable and available in a space-saving 0.9mm x 1.3mm, 6-bump WLP package.

Applications

- Cell Phones
- Tablet/Notebook Computers
- Mobile Accessories
- Battery-Powered Devices

Benefits and Features

- Ultra-Low 750nA Supply Current per Amplifier
- Ultra-Low +1.8V Supply Voltage Operation
- Ground-Sensing Input Common-Mode Range
- Outputs Swing Rail-to-Rail
- Outputs Source and Sink 11mA of Load Current
- No Phase Reversal for Overdriven Inputs
- High 120dB Open-Loop Voltage Gain
- Low 500 μ V Input Offset Voltage
- 9kHz Gain-Bandwidth Product
- 250pF (min) Capacitive Load Capability
- Available in a Tiny, 0.9mm x 1.3mm, 6-Bump WLP Package

Ordering Information

PART	TEMP RANGE	PIN-PACKAGE	TOP MARK
MAX44264EWT+	-40°C to +85°C	6 WLP	+CB

+Denotes a lead(Pb)-free/RoHS-compliant package.

Absolute Maximum Ratings

V _{DD} to V _{SS}	-0.3V to +6V	Operating Temperature Range.....	-40°C to +85°C
IN ₊ or IN ₋	(V _{SS} - 0.3V) to (V _{DD} + 0.3V)	Junction Temperature.....	+150°C
OUT ₋ Shorted to V _{SS} or V _{DD}	Continuous	Storage Temperature Range.....	-65°C to +150°C
Continuous Power Dissipation (T _A = +70°C)		Lead Temperature (soldering, 10s).....	+300°C
6-Bump WLP (derate 10.5mW/°C above +70°C).....	840mW	Soldering Temperature (reflow).....	+260°C

Stresses beyond those listed under "Absolute Maximum Ratings" may cause permanent damage to the device. These are stress ratings only, and functional operation of the device at these or any other conditions beyond those indicated in the operational sections of the specifications is not implied. Exposure to absolute maximum rating conditions for extended periods may affect device reliability.

Electrical Characteristics

(V_{DD} = +5V, V_{SS} = 0V, V_{CM} = 0V, V_{OUT} = V_{DD}/2, R_L = ∞ to V_{DD}/2, T_A = +25°C, unless otherwise noted.)

PARAMETER	SYMBOL	CONDITIONS	MIN	TYP	MAX	UNITS	
Supply Voltage Range	V _{DD}	Guaranteed by PSRR tests	1.8		5.5	V	
Supply Current (per Amplifier)	I _{DD}	V _{DD} = +1.8V		0.6		μA	
		V _{DD} = +5.0V		0.75	1.2		
Input Offset Voltage	V _{OS}			±0.5	±7.0	mV	
Input Bias Current	I _B			±200	±1500	pA	
Input Offset Current	I _{OS}			±12.5		pA	
Input Common-Mode Voltage Range	V _{CM}	Guaranteed by the CMRR test	V _{SS}		V _{DD} - 1.1	V	
Common-Mode Rejection Ratio	CMRR	Specified with V _{SS} ≤ V _{CM} ≤ (V _{DD} - 1.1V)	70	95		dB	
Power-Supply Rejection Ratio	PSRR	+1.8V ≤ V _{DD} ≤ +5.5V	70	90		dB	
Large-Signal Voltage Gain	A _{VOL}	R _L = 1MΩ, V _{OUT} = 50mV to V _{DD} - 50mV	90	120		dB	
		R _L = 100kΩ, V _{OUT} = 200mV to V _{DD} - 200mV	90	112			
		R _L = 10kΩ, V _{OUT} = 200mV to V _{DD} - 200mV		100			
Output Voltage Swing	V _{OH}	Swing high specified as V _{DD} - V _{OH}	R _L = 1MΩ		1	4	mV
			R _L = 100kΩ		4	10	
			R _L = 10kΩ		40		
	V _{OL}	Swing low specified as V _{OL} - V _{SS}	R _L = 1MΩ		0.5	5	
			R _L = 100kΩ		1	5	
			R _L = 10kΩ		10		
Gain-Bandwidth Product	GBW			9		kHz	
Phase Margin	Φ _M			90		degrees	

Electrical Characteristics (continued)(V_{DD} = +5V, V_{SS} = 0V, V_{CM} = 0V, V_{OUT} = V_{DD}/2, R_L = ∞ to V_{DD}/2, T_A = +25°C, unless otherwise noted.)

PARAMETER	SYMBOL	CONDITIONS	MIN	TYP	MAX	UNITS
Slew Rate	SR	V _{OUT} = 4V step		2		V/ms
Input Voltage Noise	e _n	f = 1kHz		150		nV/√Hz
		f = 10kHz		120		
Output Short-Circuit Current		Shorted to V _{SS} (sourcing)		11		mA
		Shorted to V _{DD} (sinking)		36		
Power-On Time	t _{ON}			2		μs
Power-Off Time	t _{OFF}			2		μs
Capacitive Load	C _{LOAD}	No sustained oscillations	250			pF

Electrical Characteristics(V_{DD} = +5V, V_{SS} = 0V, V_{CM} = 0V, V_{OUT} = V_{DD}/2, R_L = ∞ to V_{DD}/2, T_A = T_{MIN} to T_{MAX}, unless otherwise noted.) (Note 1)

PARAMETER	SYMBOL	CONDITIONS	MIN	TYP	MAX	UNITS
Supply Voltage Range	V _{DD}	Guaranteed by PSRR tests	1.8		5.5	V
Supply Current (per Amplifier)	I _{DD}	V _{DD} = +5.0V			1.5	μA
Input Offset Voltage	V _{OS}				±15	mV
Input Offset Voltage Temperature Coefficient	TCV _{OS}			8		μV/°C
Input Bias Current	I _B				4.25	nA
Input Common-Mode Voltage Range	V _{CM}	Guaranteed by the CMRR test	V _{SS}		V _{DD} - 1.1	V
Common-Mode Rejection Ratio	CMRR	V _{SS} ≤ V _{CM} ≤ (V _{DD} - 1.1V)	56			dB
Power-Supply Rejection Ratio	PSRR	+1.8V ≤ V _{DD} ≤ +5.5V, 0°C ≤ T _A ≤ +85°C	65			dB
		+2V ≤ V _{DD} ≤ +5.5V, -40°C ≤ T _A ≤ +85°C	65			
Large-Signal Voltage Gain	A _{VOL}	V _{OUT} = 50mV to V _{DD} - 50mV, R _L = 1MΩ	75			dB
		V _{OUT} = 200mV to V _{DD} - 200mV, R _L = 100kΩ	75			
Output Voltage Swing	V _{OH}	Swing high specified as V _{DD} - V _{OH}	R _L = 1MΩ		5	mV
			R _L = 100kΩ		15	
	V _{OL}	Swing low specified as V _{OL} - V _{SS}	R _L = 1MΩ		5	
			R _L = 100kΩ		5	

Note 1: All devices are production tested at T_A = +25°C. All temperature limits are guaranteed by design.

Typical Operating Characteristics

($V_{DD} = +5V$, $V_{SS} = 0V$, $V_{CM} = 0V$, $R_L = 100k\Omega$ to $V_{DD}/2$, $T_A = +25^\circ C$, unless otherwise noted.)

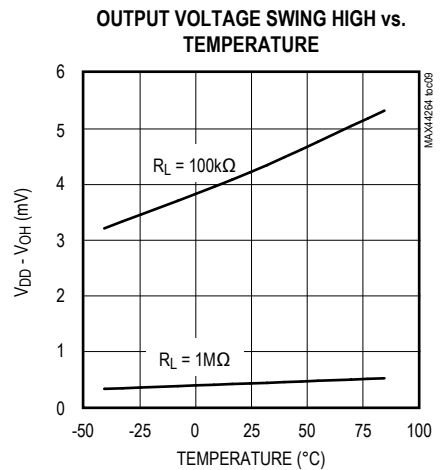
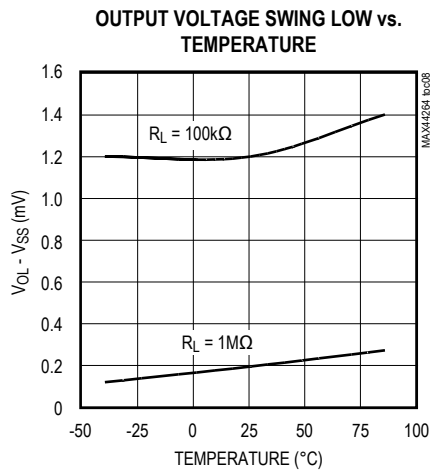
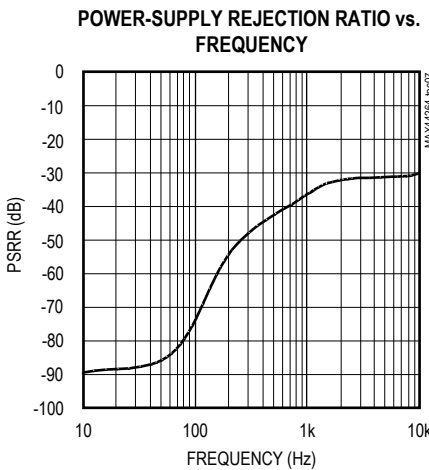
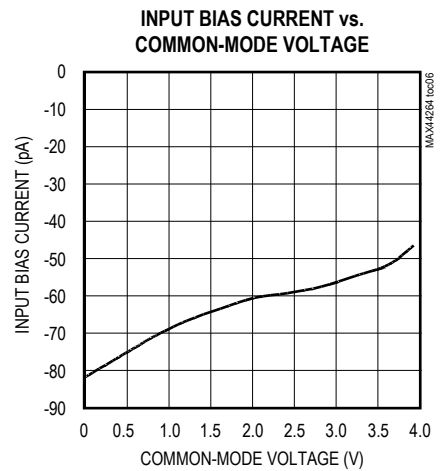
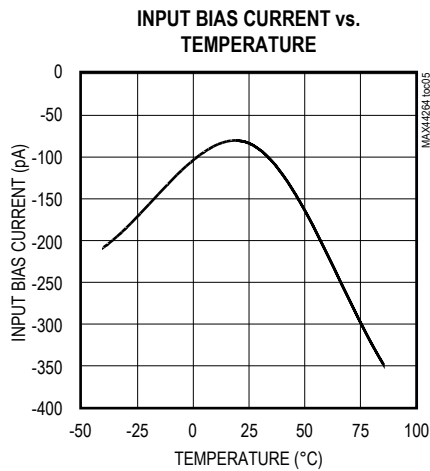
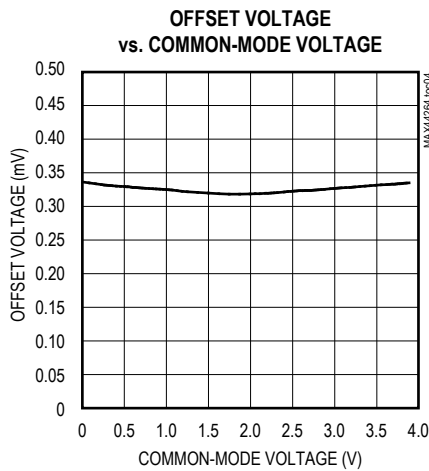
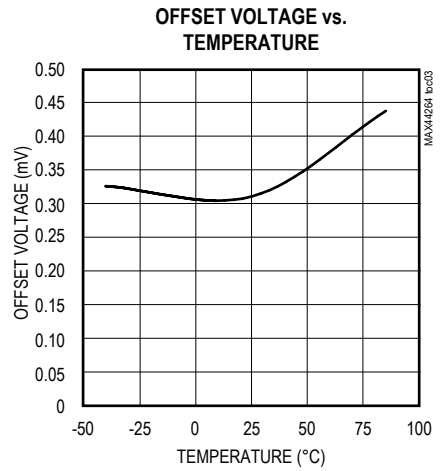
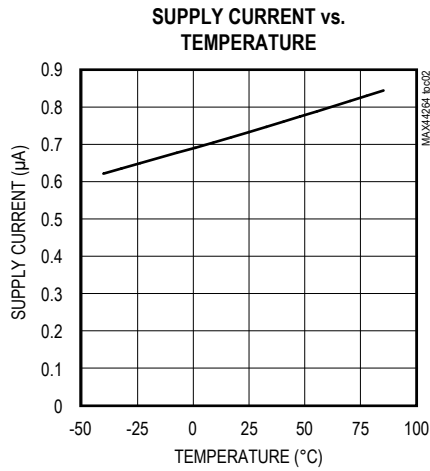
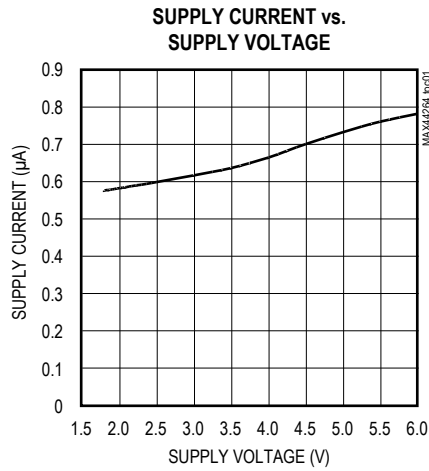

Typical Operating Characteristics (continued)

($V_{DD} = +5V$, $V_{SS} = 0V$, $V_{CM} = 0V$, $R_L = 100k\Omega$ to $V_{DD}/2$, $T_A = +25^\circ C$, unless otherwise noted.)

COMMON-MODE REJECTION RATIO vs. TEMPERATURE

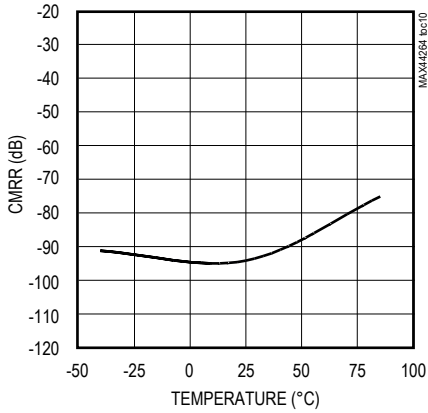

MINIMUM SUPPLY VOLTAGE vs. TEMPERATURE

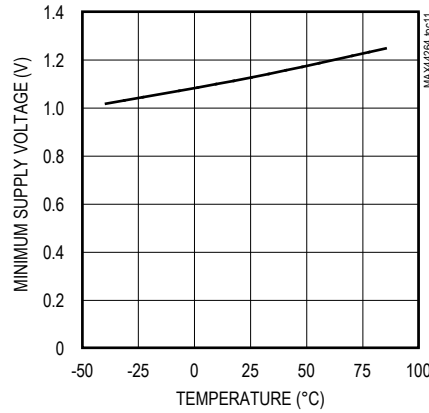

AvOL vs. OUTPUT VOLTAGE SWING

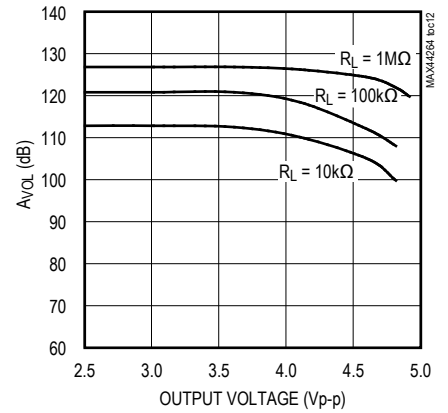

GAIN AND PHASE vs. FREQUENCY

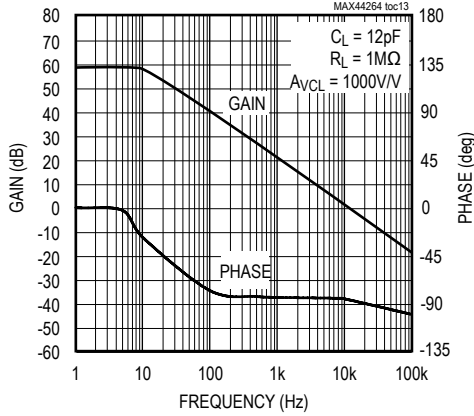

GAIN AND PHASE vs. FREQUENCY

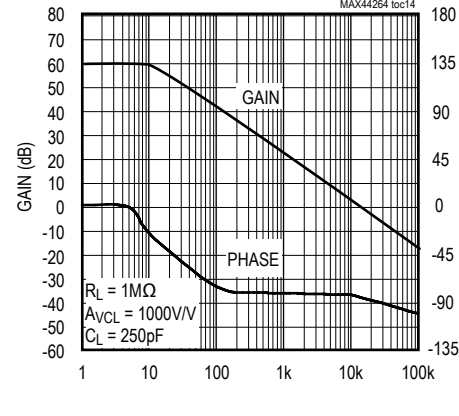

TOTAL HARMONIC DISTORTION PLUS NOISE vs. FREQUENCY

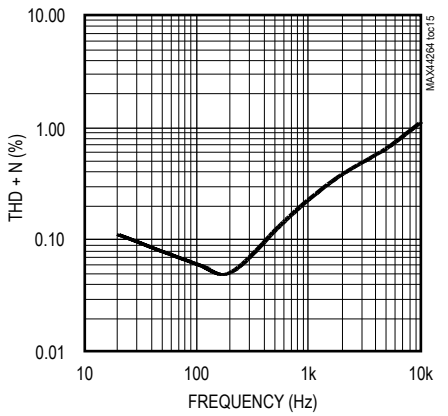

VOLTAGE NOISE DENSITY vs. FREQUENCY

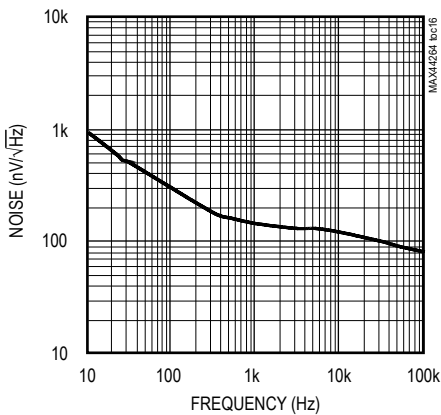

STABILITY vs. CAPACITIVE AND RESISTIVE LOADS

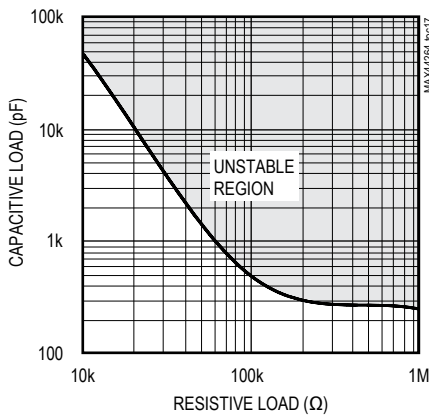

IOUT vs. VOUT

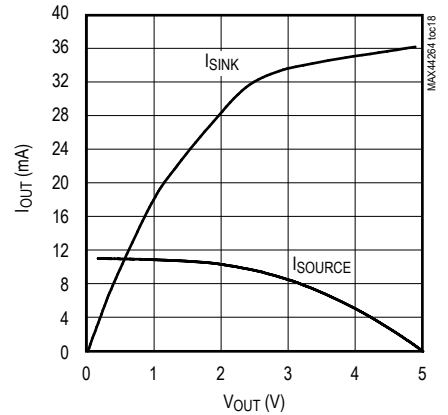

Typical Operating Characteristics (continued)

($V_{DD} = +5V$, $V_{SS} = 0V$, $V_{CM} = 0V$, $R_L = 100k\Omega$ to $V_{DD}/2$, $T_A = +25^\circ C$, unless otherwise noted.)

SMALL-SIGNAL STEP RESPONSE

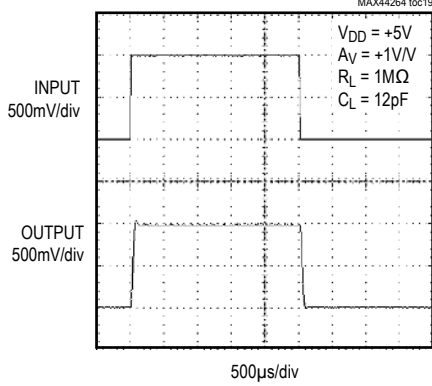

SMALL-SIGNAL STEP RESPONSE

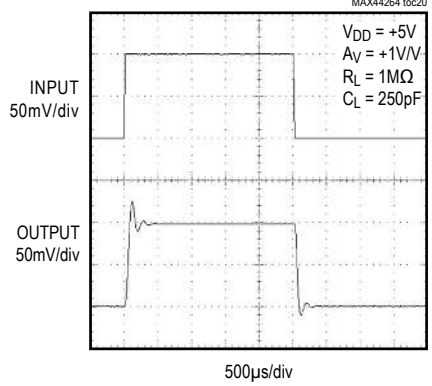

SMALL-SIGNAL STEP RESPONSE

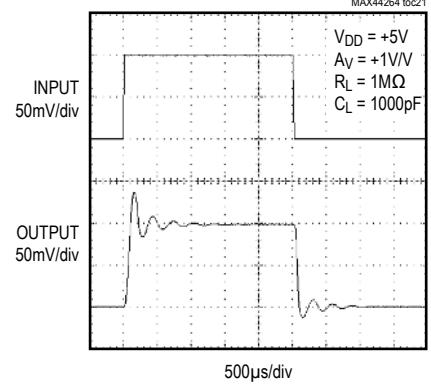

LARGE-SIGNAL STEP RESPONSE

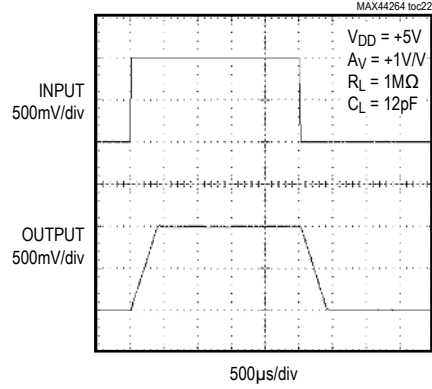

LARGE-SIGNAL STEP RESPONSE

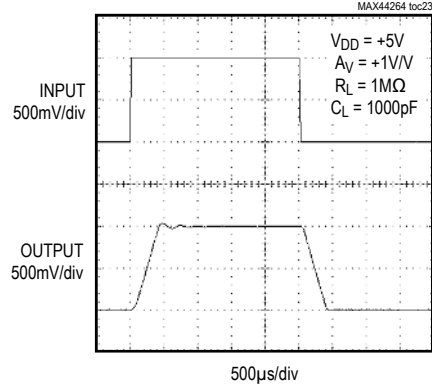

PERCENT OVERSHOOT vs. CAPACITIVE LOAD

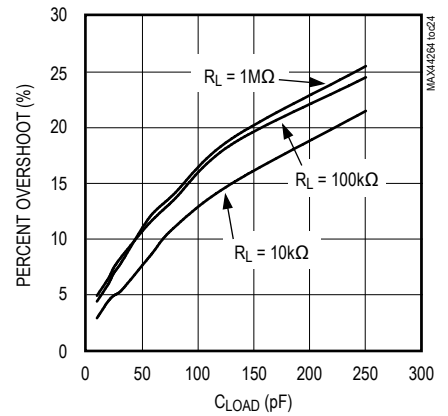

SMALL-SIGNAL GAIN vs. FREQUENCY

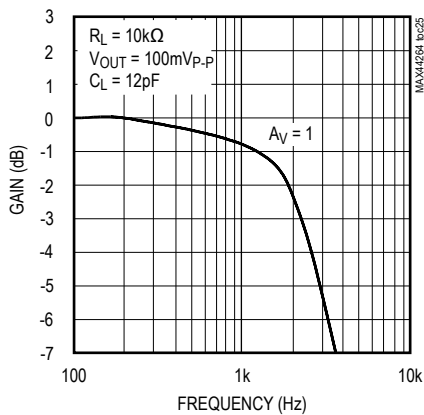

SMALL-SIGNAL GAIN vs. FREQUENCY

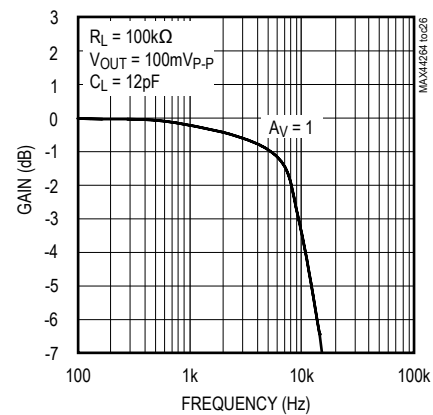

Typical Operating Characteristics (continued)

($V_{DD} = +5V$, $V_{SS} = 0V$, $V_{CM} = 0V$, $R_L = 100k\Omega$ to $V_{DD}/2$, $T_A = +25^\circ C$, unless otherwise noted.)

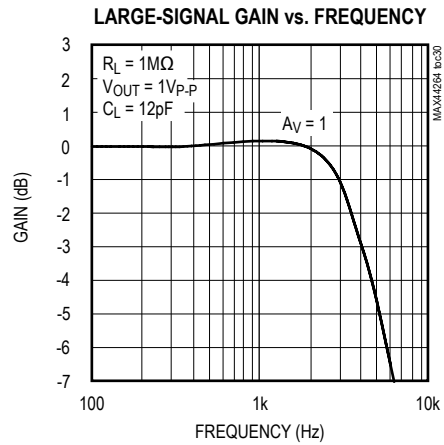
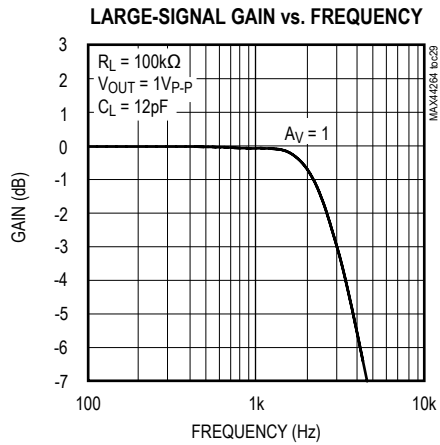
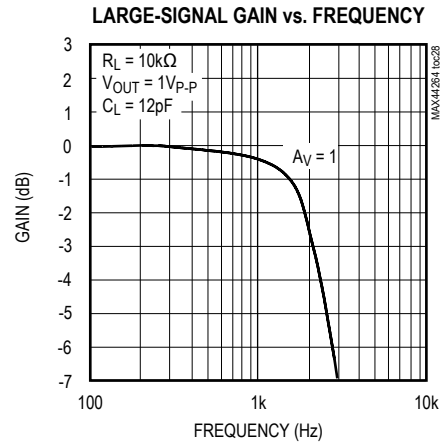
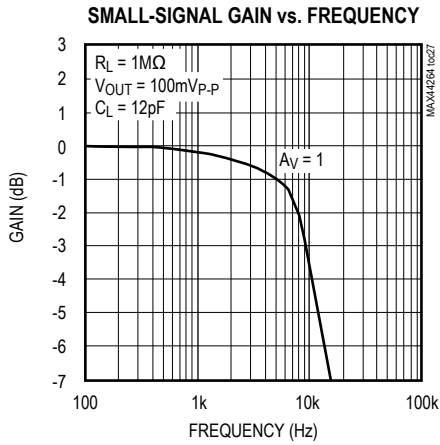

Pin Configuration

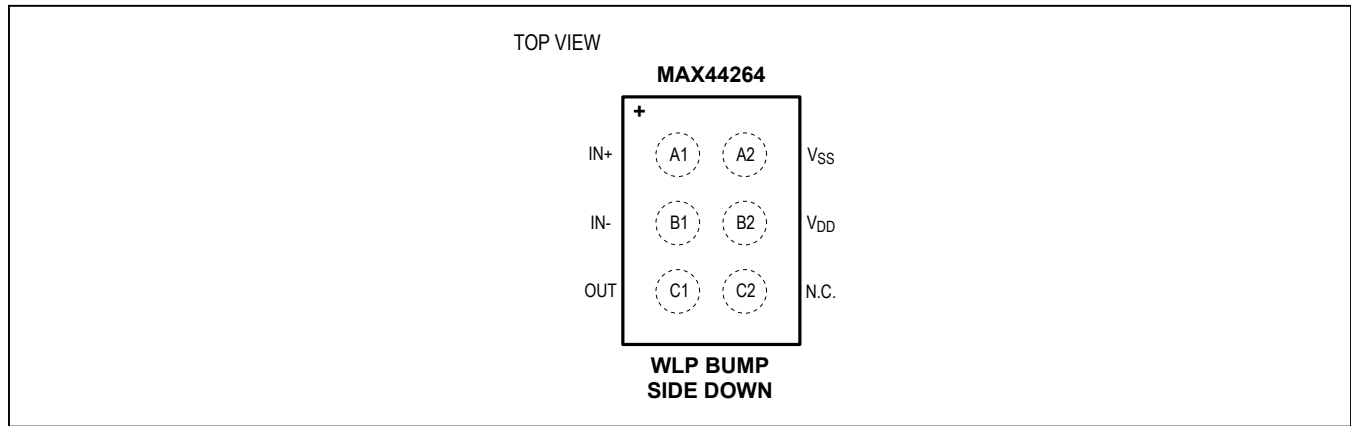

Pin Description

PIN	NAME	FUNCTION
A1	IN+	Noninverting Amplifier Input
A2	V _{SS}	Negative Power-Supply Voltage
B1	IN-	Inverting Amplifier Input
B2	V _{DD}	Positive Power-Supply Voltage
C1	OUT	Amplifier Output
C2	N.C.	No Connection. Not internally connected.

Applications Information

Ground Sensing

The common-mode input range of the MAX44264 extends down to ground, and offers excellent common-mode rejection. These devices are guaranteed not to undergo phase reversal when the input is overdriven.

Power Supplies and Layout

The IC operates from a single +1.8V to +5.5V power supply. Bypass power supplies with a 0.1µF ceramic capacitor placed close to the V_{DD} pin.

Ground layout improves performance by decreasing the amount of stray capacitance and noise at the op amp's inputs and outputs. To decrease stray capacitance, minimize PCB lengths and resistor leads, and place external components close to the op amps' pins.

Bandwidth

The IC is internally compensated for unity-gain stability and has a typical gain-bandwidth of 9kHz.

Stability

The IC maintains stability in their minimum gain configuration while driving capacitive loads. Although this product family is primarily designed for low-frequency applications,

good layout is extremely important because low-power requirements demand high-impedance circuits. The layout should also minimize stray capacitance at the amplifier inputs. However some stray capacitance may be unavoidable, and it may be necessary to add a 2pF to 10pF capacitor across the feedback resistor as shown in [Figure 1](#). Select the smallest capacitor value that ensures stability.

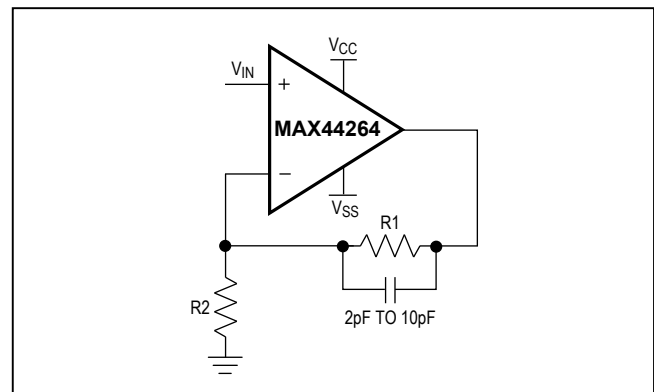

Figure 1. Compensation for Feedback Node Capacitance

Chip Information

PROCESS: BiCMOS

Package Information

For the latest package outline information and land patterns (footprints), go to www.maximintegrated.com/packages. Note that a “+”, “#”, or “-” in the package code indicates RoHS status only. Package drawings may show a different suffix character, but the drawing pertains to the package regardless of RoHS status.

PACKAGE TYPE	PACKAGE CODE	OUTLINE NO.	LAND PATTERN NO.
6 WLP	W61B1+1	21-0217	—

Pin 1 Indicator

Marking

TOP VIEW

SIDE VIEW

FRONT VIEW

BOTTOM VIEW

COMMON DIMENSIONS	
A	0.64 ±0.05
A1	0.19 ±0.03
A2	0.45 REF
A3	0.025 BASIC
b	∅0.27 ±0.03
D	1.235 ±0.015
E	0.835 ±0.015
D1	0.80 BASIC
E1	0.40 BASIC
e	0.40 BASIC
SD	0.00 BASIC
SE	0.20 BASIC
DEPOPULATED BUMPS: NONE	

NOTES:

1. Terminal pitch is defined by terminal center to center value.
2. Outer dimension is defined by center lines between scribe lines.
3. All dimensions in millimeter.
4. Marking shown is for package orientation reference only.
5. Tolerance is ± 0.02 unless specified otherwise.
6. All dimensions apply to PbFree (+) package codes only.
7. Front - side finish can be either Black or Clear.

- DRAWING NOT TO SCALE -

TITLE PACKAGE OUTLINE 6 BUMPS WLP PKG. 0.4 mm PITCH, W61F0+1		
APPROVAL	DOCUMENT CONTROL NO. 21-0217	REV. F 1/1

Revision History

REVISION NUMBER	REVISION DATE	DESCRIPTION	PAGES CHANGED
0	12/10	Initial release	—
1	3/17	Updated title to include “nanoPower”	1–10

For pricing, delivery, and ordering information, please contact Maxim Direct at 1-888-629-4642, or visit Maxim Integrated's website at www.maximintegrated.com.

Maxim Integrated cannot assume responsibility for use of any circuitry other than circuitry entirely embodied in a Maxim Integrated product. No circuit patent licenses are implied. Maxim Integrated reserves the right to change the circuitry and specifications without notice at any time. The parametric values (min and max limits) shown in the Electrical Characteristics table are guaranteed. Other parametric values quoted in this data sheet are provided for guidance.