

Dual 30-V N-Channel NexFET™ Power MOSFETs

FEATURES

- Common Source Connection
- Ultra Low Drain to Drain On-Resistance
- Space Saving SON 3.3 x 3.3mm Plastic Package
- Optimized for 5V Gate Drive
- Low Thermal Resistance
- Avalanche Rated
- Pb Free Terminal Plating
- RoHS Compliant
- Halogen Free

APPLICATIONS

- Adaptor/USB Input Protection for Notebook PCs and Tablets

DESCRIPTION

The CSD87312Q3E is a 30V common-source, dual N-channel device designed for adaptor/USB input protection. This SON 3.3 x 3.3mm device has low drain to drain on-resistance that minimizes losses and offers low component count for space constrained multi-cell battery charging applications.

PRODUCT SUMMARY

$T_A = 25^\circ\text{C}$		TYPICAL VALUE		UNIT
V_{DS}	Drain to Source Voltage	30		V
Q_g	Gate Charge Total (4.5V)	6.3		nC
Q_{gd}	Gate Charge Gate to Drain	0.7		nC
$R_{DD(on)}$	Drain to Drain On Resistance (Q1+Q2)	$V_{GS} = 4.5\text{V}$	31	m Ω
		$V_{GS} = 8\text{V}$	27	m Ω
$V_{GS(th)}$	Threshold Voltage	1.0		V

ORDERING INFORMATION

Device	Package	Media	Qty	Ship
CSD87312Q3E	SON 3.3 x 3.3mm Plastic Package	13-Inch Reel	2500	Tape and Reel

ABSOLUTE MAXIMUM RATINGS

$T_A = 25^\circ\text{C}$		VALUE	UNIT
V_{DS}	Drain to Source Voltage	30	V
V_{GS}	Gate to Source Voltage	+10/-8	V
I_D	Continuous Drain Current, $T_C = 25^\circ\text{C}^{(1)}$	27	A
I_{DM}	Pulsed Drain Current $^{(2)}$	45	A
P_D	Power Dissipation	2.5	W
T_J, T_{STG}	Operating Junction and Storage Temperature Range	-55 to 150	$^\circ\text{C}$
E_{AS}	Avalanche Energy, single pulse $I_D = 24\text{A}, L = 0.1\text{mH}, R_G = 25\Omega$	29	mJ

(1) Typical $R_{\theta JC} = 63^\circ\text{C/W}$ on 1in^2 (2 oz.) on 0.060" thick FR4PCB

(2) Pulse duration $\leq 300\mu\text{s}$, duty cycle $\leq 2\%$

Top View

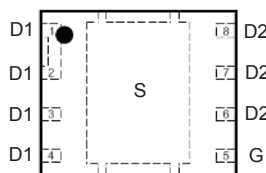

Circuit Image

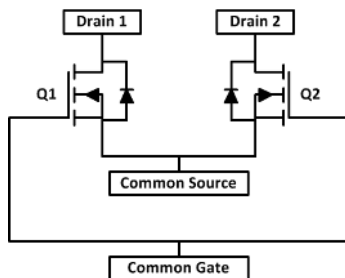

V_{GS} vs. R_{DDon}

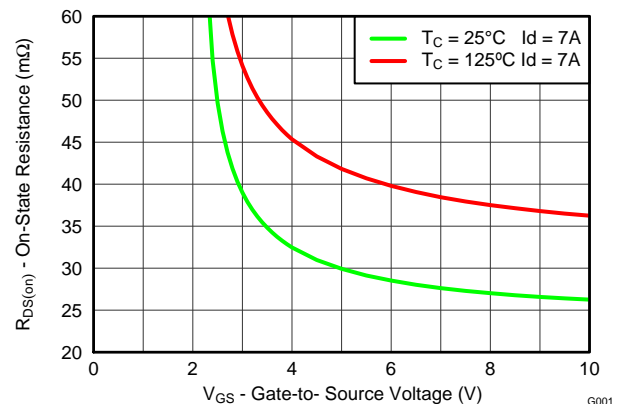

Please be aware that an important notice concerning availability, standard warranty, and use in critical applications of Texas Instruments semiconductor products and disclaimers thereto appears at the end of this data sheet.



These devices have limited built-in ESD protection. The leads should be shorted together or the device placed in conductive foam during storage or handling to prevent electrostatic damage to the MOS gates.

ELECTRICAL CHARACTERISTICS

($T_A = 25^\circ\text{C}$ unless otherwise stated)

PARAMETER		TEST CONDITIONS	MIN	TYP	MAX	UNIT
Static Characteristics						
BV_{DSS}	Drain to Source Voltage	$V_{GS} = 0V, I_D = 250\mu A$	30			V
I_{DSS}	Drain to Source Leakage Current	$V_{GS} = 0V, V_{DS} = 24V$			1	μA
I_{GSS}	Gate to Source Leakage Current	$V_{DS} = 0V, V_{GS} = +10/-8V$			100	nA
$V_{GS(th)}$	Gate to Source Threshold Voltage	$V_{DS} = V_{GS}, I_D = 250\mu A$	0.8	1.0	1.3	V
$R_{DD(on)}$	Drain to Drain On Resistance (Q1 + Q2)	$V_{GS} = 4.5V, I_D = 7A$		31	38	$m\Omega$
		$V_{GS} = 8V, I_D = 7A$		27	33	$m\Omega$
g_{fs}	Transconductance	$V_{DS} = 15V, I_D = 7A$		39		S
Dynamic Characteristics⁽¹⁾						
C_{iss}	Input Capacitance	$V_{GS} = 0V, V_{DS} = 15V, f = 1MHz$		960	1250	pF
C_{oss}	Output Capacitance			190	247	pF
C_{riss}	Reverse Transfer Capacitance			12	16	pF
R_G	Series Gate Resistance			5	10	Ω
Q_g	Gate Charge Total (4.5V)	$V_{DS} = 15V, I_D = 7A$		6.3	8.2	nC
Q_{gd}	Gate Charge Gate to Drain			0.7		nC
Q_{gs}	Gate Charge Gate to Source			1.9		nC
$Q_{g(th)}$	Gate Charge at V_{th}			1.0		nC
Q_{oss}	Output Charge	$V_{DS} = 15V, V_{GS} = 0V$		4.0		nC
$t_{d(on)}$	Turn On Delay Time	$V_{DS} = 15V, V_{GS} = 4.5V, I_{DS} = 7A, R_G = 2\Omega$		7.8		ns
t_r	Rise Time			16		ns
$t_{d(off)}$	Turn Off Delay Time			17		ns
t_f	Fall Time			2.9		ns
Diode Characteristics⁽¹⁾						
V_{SD}	Diode Forward Voltage	$I_{SD} = 7A, V_{GS} = 0V$		0.8	1	V
Q_{rr}	Reverse Recovery Charge	$V_{DS} = 15V, I_F = 7A, di/dt = 300A/\mu s$		5.3		nC
t_{rr}	Reverse Recovery Time			12.2		ns

(1) All Dynamic and Diode Characteristics were measured with respect to one of the two drains, with the other left floating.

THERMAL CHARACTERISTICS

($T_A = 25^\circ\text{C}$ unless otherwise stated)

PARAMETER		MIN	TYP	MAX	UNIT
$R_{\theta JC}$	Thermal Resistance Junction to Case ⁽¹⁾			4.2	$^\circ\text{C}/W$
$R_{\theta JA}$	Thermal Resistance Junction to Ambient ⁽¹⁾⁽²⁾			63	$^\circ\text{C}/W$

- (1) $R_{\theta JC}$ is determined with the device mounted on a 1-inch² (6.45-cm²), 2-oz. (0.071-mm thick) Cu pad on a 1.5-inch x 1.5-inch (3.81-cm x 3.81-cm), 0.06-inch (1.52-mm) thick FR4 PCB. $R_{\theta JC}$ is specified by design, whereas $R_{\theta JA}$ is determined by the user's board design.
- (2) Device mounted on FR4 material with 1-inch² (6.45-cm²), 2-oz. (0.071-mm thick) Cu.

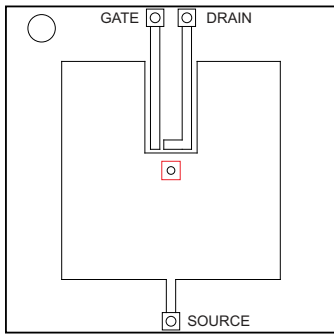

Max $R_{\theta JA} = 63^{\circ}\text{C/W}$
when mounted on
1 inch² (6.45 cm²) of 2-
oz. (0.071-mm thick)
Cu.

M0137-01

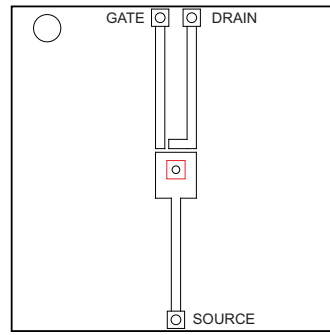

Max $R_{\theta JA} = 165^{\circ}\text{C/W}$
when mounted on a
minimum pad area of
2-oz. (0.071-mm thick)
Cu.

M0137-02

TYPICAL MOSFET CHARACTERISTICS

($T_A = 25^{\circ}\text{C}$ unless otherwise stated)

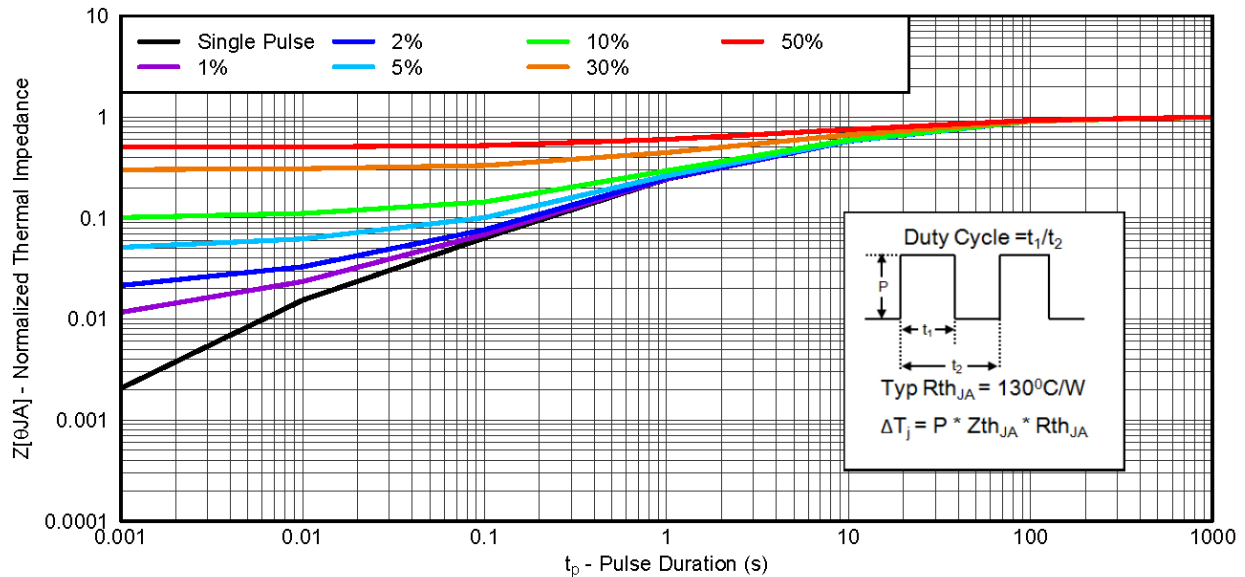

G001

Figure 1. Transient Thermal Impedance

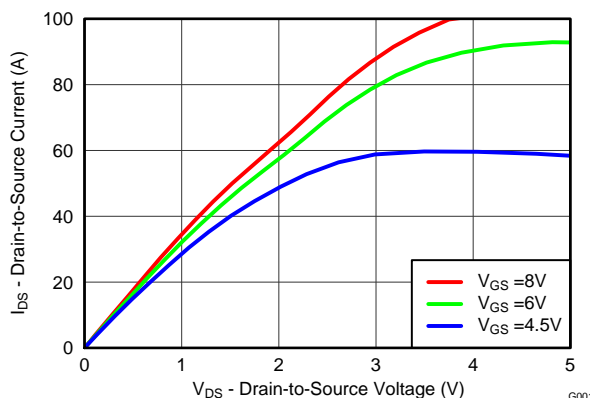

G001

Figure 2. Saturation Characteristics

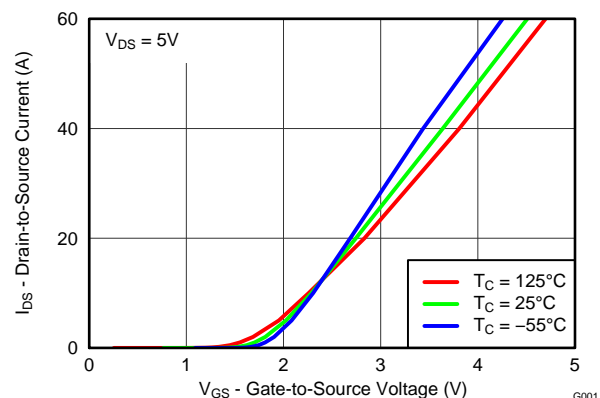

G001

Figure 3. Transfer Characteristics

TYPICAL MOSFET CHARACTERISTICS (continued)

($T_A = 25^\circ\text{C}$ unless otherwise stated)

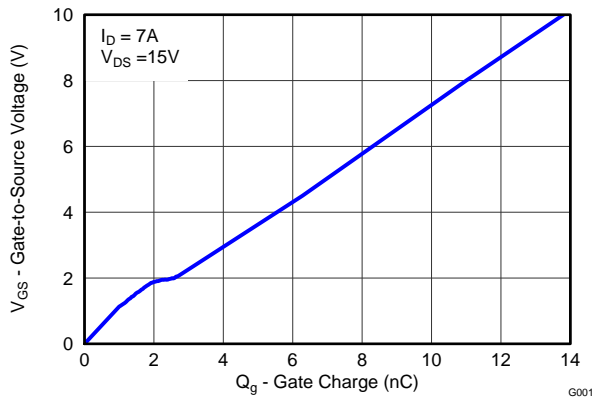

Figure 4. Gate Charge

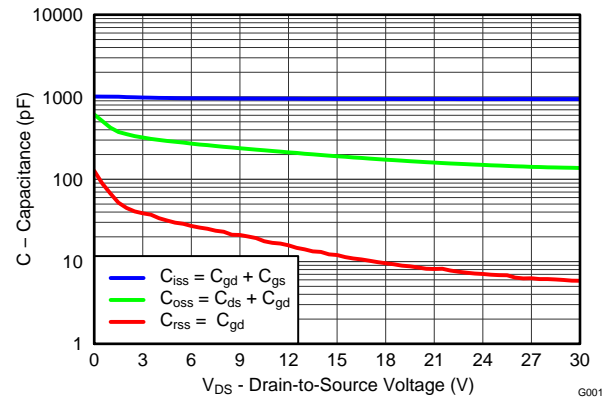

Figure 5. Capacitance

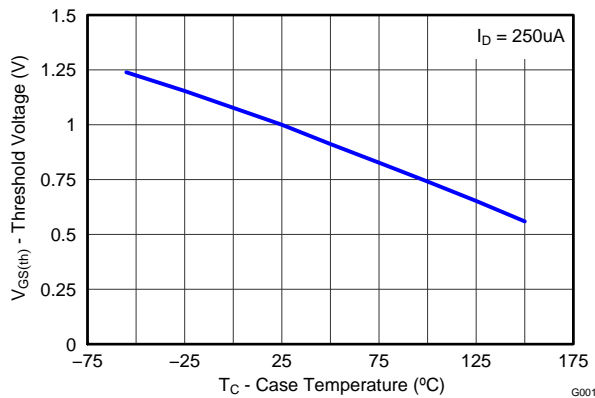

Figure 6. Threshold Voltage vs. Temperature

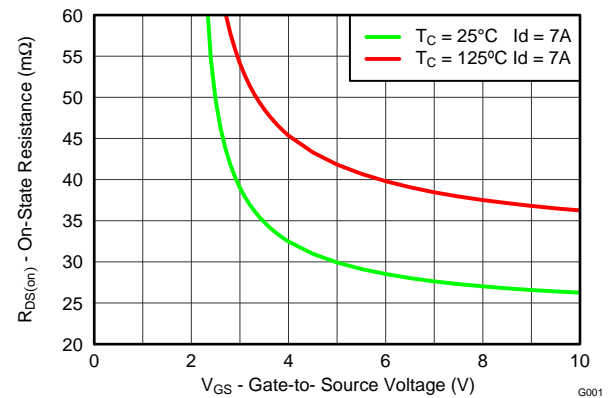

Figure 7. On-State Resistance vs. Gate-to-Source Voltage

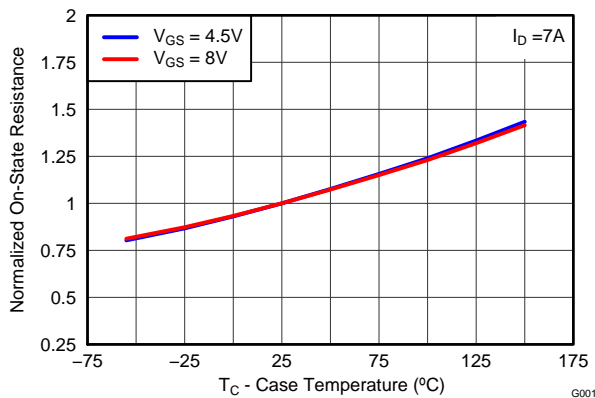

Figure 8. Normalized On-State Resistance vs. Temperature

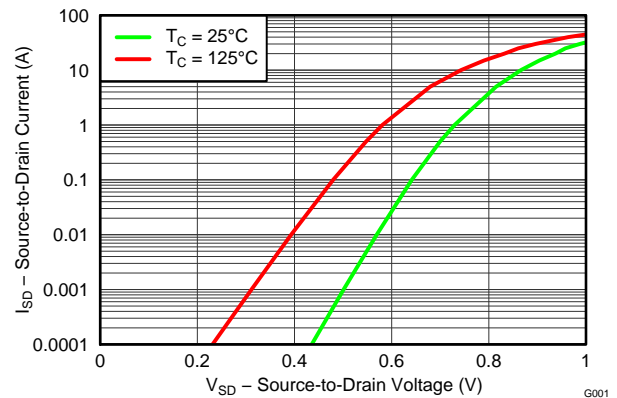

Figure 9. Typical Diode Forward Voltage

TYPICAL MOSFET CHARACTERISTICS (continued)

($T_A = 25^\circ\text{C}$ unless otherwise stated)

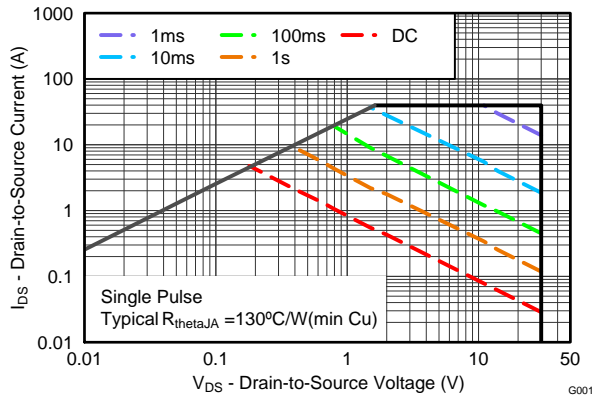

Figure 10. Maximum Safe Operating Area

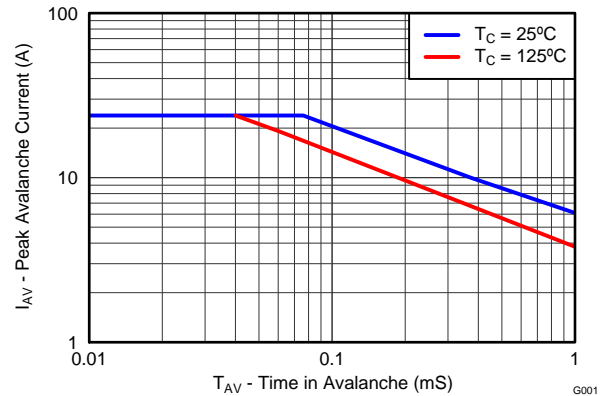

Figure 11. Single Pulse Unclamped Inductive Switching

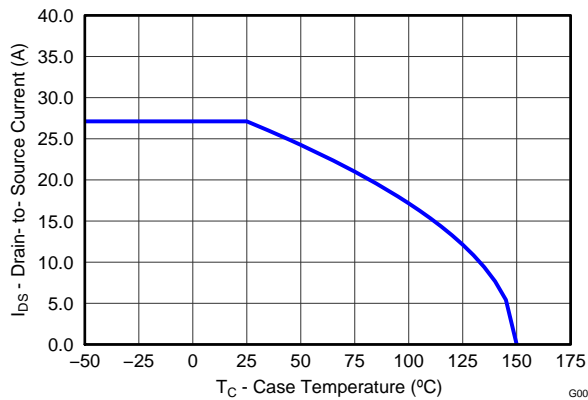
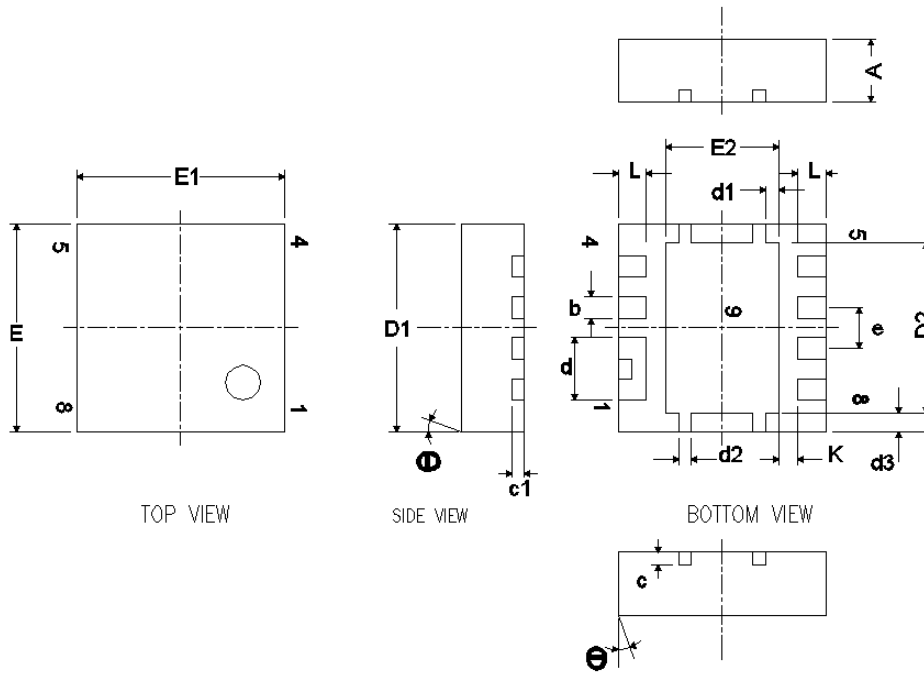

Figure 12. Maximum Drain Current vs. Temperature

MECHANICAL DATA

Q3E Package Dimensions



DIM	MILLIMETERS	
	MIN	MAX
A	0.850	1.050
b	0.280	0.400
c	0.150	0.250
c1	0.150	0.250
d	0.940	1.040
d1	0.160	0.260
d2	0.150	0.250
d3	0.250	0.350
D1	3.200	3.400
D2	2.650	2.750
E	3.200	3.400
E1	3.200	3.400
E2	1.750	1.850
e	0.650 TYP	
L	0.400	0.500
theta	0°	-
K	0.300 Typ	

Notes:

1. Pin 1-4: Drain 1
2. Pin 5: Gate
3. Pin 6-8: Drain 2
4. Pin 9: Source

Recommended PCB Pattern

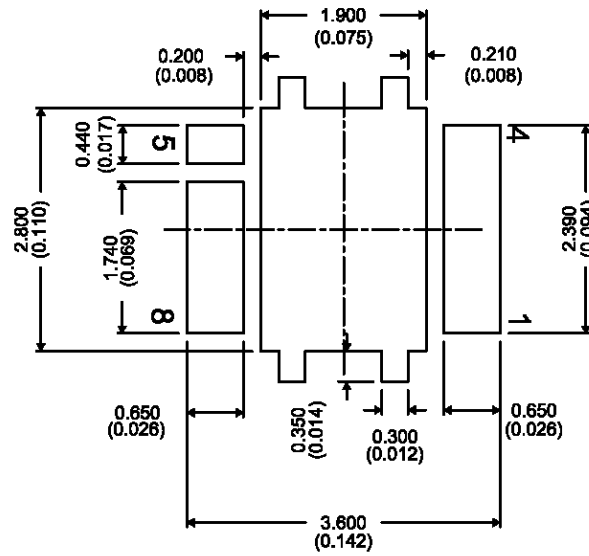

Recommended Stencil Opening

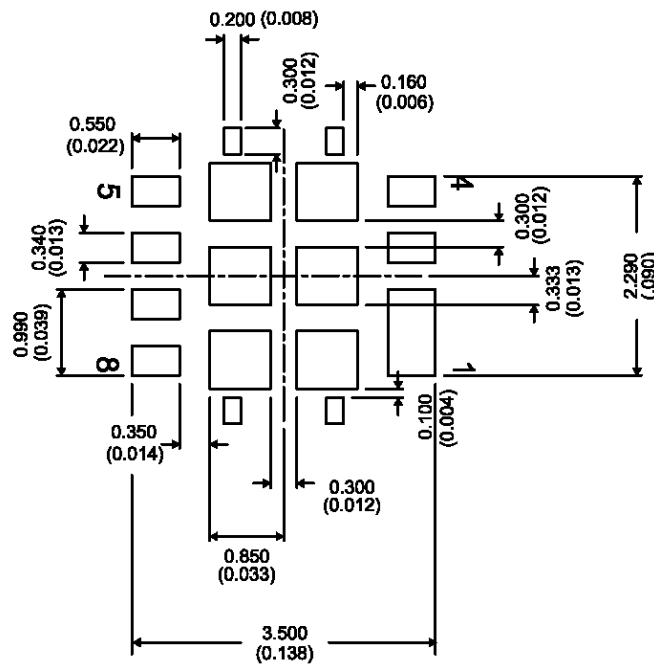

For recommended circuit layout for PCB designs, see application note [SLPA005 – Reducing Ringing Through PCB Layout Techniques](#).

Q3E Tape and Reel Information

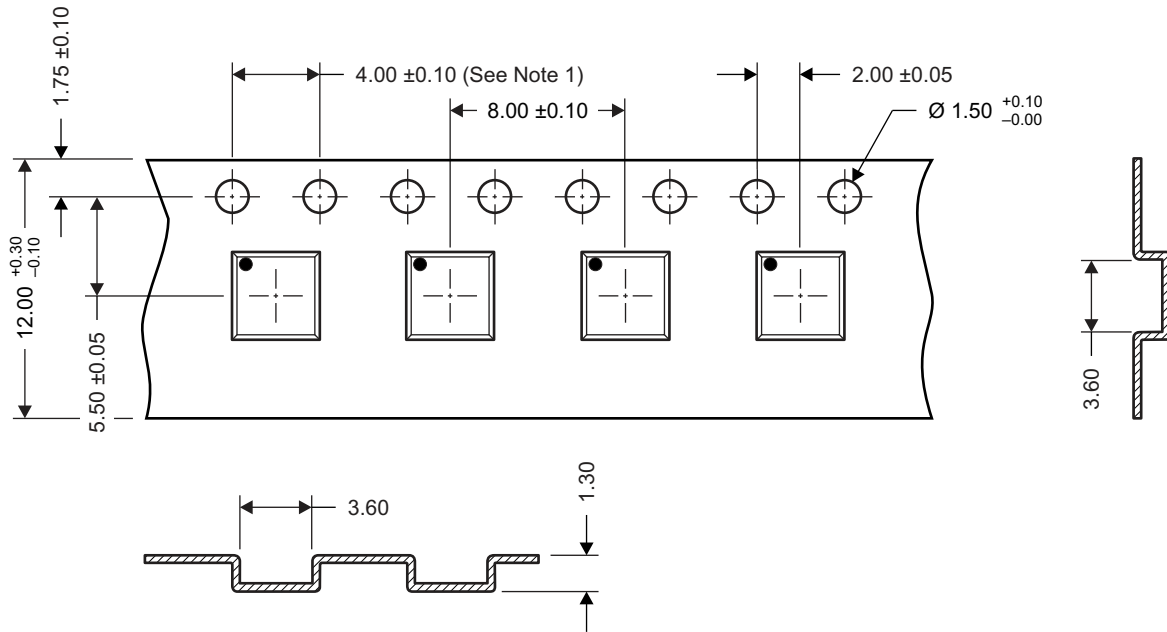

M0144-01

Notes:

1. 10 sprocket hole pitch cumulative tolerance ± 0.2
2. Camber not to exceed 1mm IN 100mm, noncumulative over 250mm
3. Material: black static dissipative polystyrene
4. All dimensions are in mm (unless otherwise specified)
5. Thickness: 0.30 ± 0.05 mm
6. MSL1 260°C (IR and Convection) PbF Reflow Compatible

PACKAGING INFORMATION

Orderable Device	Status (1)	Package Type	Package Drawing	Pins	Package Qty	Eco Plan (2)	Lead finish/ Ball material (6)	MSL Peak Temp (3)	Op Temp (°C)	Device Marking (4/5)	Samples
CSD87312Q3E	ACTIVE	VSON	DPA	8	2500	RoHS-Exempt & Green	NIPDAU	Level-1-260C-UNLIM	-55 to 150	87312E	Samples

(1) The marketing status values are defined as follows:

ACTIVE: Product device recommended for new designs.

LIFEBUY: TI has announced that the device will be discontinued, and a lifetime-buy period is in effect.

NRND: Not recommended for new designs. Device is in production to support existing customers, but TI does not recommend using this part in a new design.

PREVIEW: Device has been announced but is not in production. Samples may or may not be available.

OBSOLETE: TI has discontinued the production of the device.

(2) **RoHS:** TI defines "RoHS" to mean semiconductor products that are compliant with the current EU RoHS requirements for all 10 RoHS substances, including the requirement that RoHS substance do not exceed 0.1% by weight in homogeneous materials. Where designed to be soldered at high temperatures, "RoHS" products are suitable for use in specified lead-free processes. TI may reference these types of products as "Pb-Free".

RoHS Exempt: TI defines "RoHS Exempt" to mean products that contain lead but are compliant with EU RoHS pursuant to a specific EU RoHS exemption.

Green: TI defines "Green" to mean the content of Chlorine (Cl) and Bromine (Br) based flame retardants meet JS709B low halogen requirements of <=1000ppm threshold. Antimony trioxide based flame retardants must also meet the <=1000ppm threshold requirement.

(3) MSL, Peak Temp. - The Moisture Sensitivity Level rating according to the JEDEC industry standard classifications, and peak solder temperature.

(4) There may be additional marking, which relates to the logo, the lot trace code information, or the environmental category on the device.

(5) Multiple Device Markings will be inside parentheses. Only one Device Marking contained in parentheses and separated by a "~" will appear on a device. If a line is indented then it is a continuation of the previous line and the two combined represent the entire Device Marking for that device.

(6) Lead finish/Ball material - Orderable Devices may have multiple material finish options. Finish options are separated by a vertical ruled line. Lead finish/Ball material values may wrap to two lines if the finish value exceeds the maximum column width.

Important Information and Disclaimer:The information provided on this page represents TI's knowledge and belief as of the date that it is provided. TI bases its knowledge and belief on information provided by third parties, and makes no representation or warranty as to the accuracy of such information. Efforts are underway to better integrate information from third parties. TI has taken and continues to take reasonable steps to provide representative and accurate information but may not have conducted destructive testing or chemical analysis on incoming materials and chemicals. TI and TI suppliers consider certain information to be proprietary, and thus CAS numbers and other limited information may not be available for release.

In no event shall TI's liability arising out of such information exceed the total purchase price of the TI part(s) at issue in this document sold by TI to Customer on an annual basis.

TAPE AND REEL INFORMATION

QUADRANT ASSIGNMENTS FOR PIN 1 ORIENTATION IN TAPE

*All dimensions are nominal

Device	Package Type	Package Drawing	Pins	SPQ	Reel Diameter (mm)	Reel Width W1 (mm)	A0 (mm)	B0 (mm)	K0 (mm)	P1 (mm)	W (mm)	Pin1 Quadrant
CSD87312Q3E	VSON	DPA	8	2500	330.0	12.4	3.6	3.6	1.2	8.0	12.0	Q2

TAPE AND REEL BOX DIMENSIONS

*All dimensions are nominal

Device	Package Type	Package Drawing	Pins	SPQ	Length (mm)	Width (mm)	Height (mm)
CSD87312Q3E	VSON	DPA	8	2500	346.0	346.0	33.0

DPA0008A



PACKAGE OUTLINE

VSON - 1 mm max height

PLASTIC SMALL OUTLINE - NO LEAD

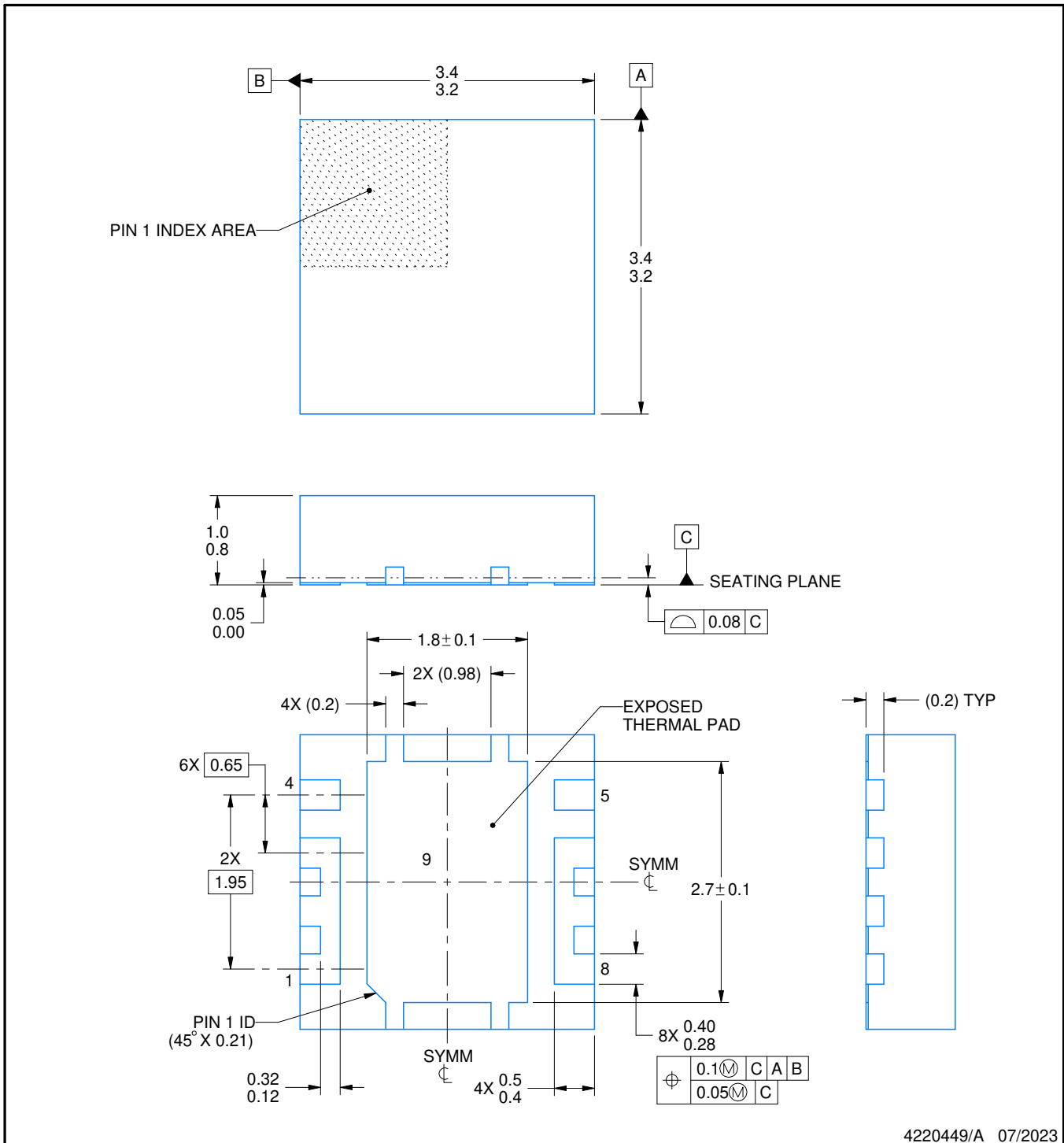

4220449/A 07/2023

NOTES:

1. All linear dimensions are in millimeters. Any dimensions in parenthesis are for reference only. Dimensioning and tolerancing per ASME Y14.5M.
2. This drawing is subject to change without notice.
3. The package thermal pad must be soldered to the printed circuit board for thermal and mechanical performance.

EXAMPLE STENCIL DESIGN

DPA0008A

VSON - 1 mm max height

PLASTIC SMALL OUTLINE - NO LEAD

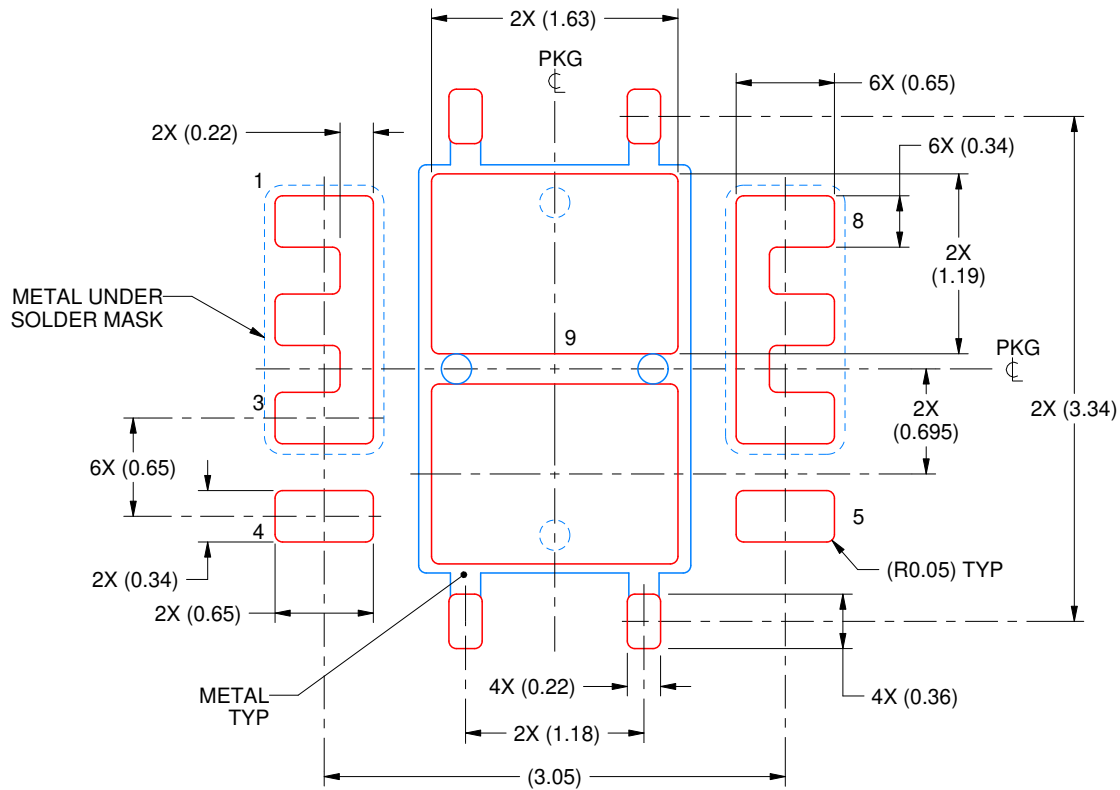

SOLDER PASTE EXAMPLE
BASED ON 0.125 mm THICK STENCIL

EXPOSED PAD 9
76% PRINTED SOLDER COVERAGE BY AREA UNDER PACKAGE
SCALE:20X

4220449/A 07/2023

NOTES: (continued)

6. Laser cutting apertures with trapezoidal walls and rounded corners may offer better paste release. IPC-7525 may have alternate design recommendations.

IMPORTANT NOTICE AND DISCLAIMER

TI PROVIDES TECHNICAL AND RELIABILITY DATA (INCLUDING DATA SHEETS), DESIGN RESOURCES (INCLUDING REFERENCE DESIGNS), APPLICATION OR OTHER DESIGN ADVICE, WEB TOOLS, SAFETY INFORMATION, AND OTHER RESOURCES "AS IS" AND WITH ALL FAULTS, AND DISCLAIMS ALL WARRANTIES, EXPRESS AND IMPLIED, INCLUDING WITHOUT LIMITATION ANY IMPLIED WARRANTIES OF MERCHANTABILITY, FITNESS FOR A PARTICULAR PURPOSE OR NON-INFRINGEMENT OF THIRD PARTY INTELLECTUAL PROPERTY RIGHTS.

These resources are intended for skilled developers designing with TI products. You are solely responsible for (1) selecting the appropriate TI products for your application, (2) designing, validating and testing your application, and (3) ensuring your application meets applicable standards, and any other safety, security, regulatory or other requirements.

These resources are subject to change without notice. TI grants you permission to use these resources only for development of an application that uses the TI products described in the resource. Other reproduction and display of these resources is prohibited. No license is granted to any other TI intellectual property right or to any third party intellectual property right. TI disclaims responsibility for, and you will fully indemnify TI and its representatives against, any claims, damages, costs, losses, and liabilities arising out of your use of these resources.

TI's products are provided subject to [TI's Terms of Sale](#) or other applicable terms available either on [ti.com](https://www.ti.com) or provided in conjunction with such TI products. TI's provision of these resources does not expand or otherwise alter TI's applicable warranties or warranty disclaimers for TI products.

TI objects to and rejects any additional or different terms you may have proposed.

Mailing Address: Texas Instruments, Post Office Box 655303, Dallas, Texas 75265
Copyright © 2023, Texas Instruments Incorporated