

ATAVRFBKIT / EVLB001
Dimmable Fluorescent Ballast

User Guide





Section 1	
Introduction	1-1
1.1 General Description	1-3
1.2 Ballast Demonstrator Features	1-3

Section 2	
Ballast Demonstrator Device Features	2-4
2.1 Atmel Supported Products	2-4
2.2 IXYS® Supported Products	2-4

Section 3	
Microcontroller Port Pin Assignments	3-6

Section 4	
Ballast Demonstrator Operation	4-7
4.1 General Requirements	4-7
4.2 Startup features	4-7
4.3 Circuit Topology	4-8
4.4 Startup and PFC Description	4-8
4.5 Lamp Operation Description	4-10

Section 5	
Device Design & Application	5-13
5.1 Magnetics	5-13
5.2 IXYS IXTP02N50D depletion mode Mosfet Used As Current Source	5-13
5.3 IXYS IXD611 Half- bridge MOSFET driver	5-13
5.4 IXYS IXI859 Charge Pump Regulator	5-14
5.5 IXYS IXTP3N50P PolarHVTM N-Channel Power MOSFET	5-15
5.6 Clare LDA111S Optocoupler	5-15

Section 6	
ATPWMX Demonstrator Software	6-16
6.1 Main_pwm_x_fluo_demo.c	6-18
6.2 Pfc_ctrl.c	6-19
6.3 Lamp_ctrl.c	6-22

Section 7	
Conclusion	7-25
7.1 Appendix 1: SWITCH DIM	7-25
7.2 Appendix 2: Capacitor Coupled Low Voltage Supply	7-26
7.3 Appendix 3: PFC Basics	7-27
7.4 Appendix 4: Bill Of Material	7-28
7.5 Appendix 5: Schematics	7-31



Section 1

Introduction

Efficient fluorescent lamps and magnetic ballasts have been the standard lighting fixture in commercial and industrial lighting for many years. Several lamp types, rapid start, high output, and others are available for cost effective and special applications. But incandescent lamps, in spite of the poor light to power ratio, typically one fourth of fluorescent, offer one feature - dimming - that hasn't been available in fluorescent lamps until now. Dimming allows the user to conserve electrical power under natural ambient light or create effects to enhance mood or image presentation and projection for example.

Typical rapid start fluorescent lamps have two pins at each end with a filament across the pins. The lamp has argon gas under low pressure and a small amount of mercury in the phosphor coated glass tube. As an AC voltage is applied at each end and the filaments are heated, electrons are driven off the filaments that collide with mercury atoms in the gas mixture. A mercury electron reaches a higher energy level then falls back to a normal state releasing a photon of ultraviolet (UV) wavelength. This photon collides with both argon assisting ionization and the phosphor coated glass tube. High voltage and UV photons ionize the argon, increasing gas conduction and releasing more UV photons. UV photons collide with the phosphor atoms increasing their electron energy state and releasing heat. Phosphor electron state decreases and releases a visible light photon. Different phosphor and gas materials can modify some of the lamp characteristics.

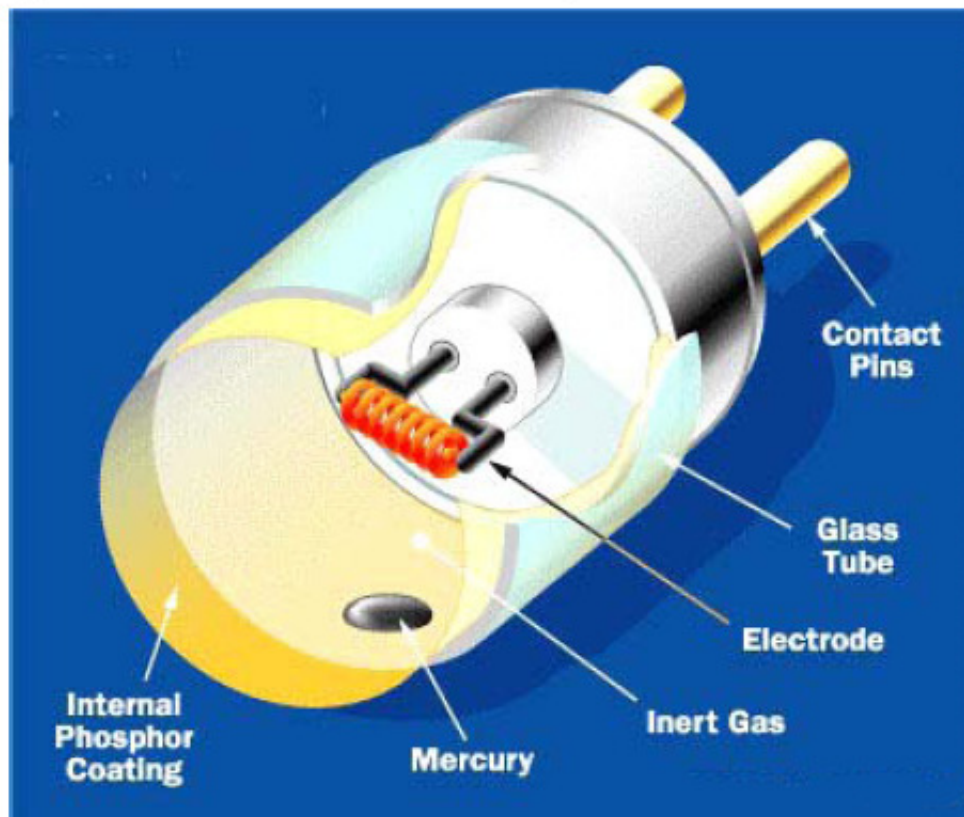
Figure 1-1. Fluorescent Tube Composition

Since the argon conductivity increases and resistance across the lamp ends decreases as the gas becomes excited, an inductance (ballast) must be used to limit and control the gas current. In the past, an inductor could be designed to limit the current for a narrow range of power voltage and frequency. A better method to control gas current is to vary an inductor's volt-seconds to achieve the desired lamp current and intensity. A variable frequency inverter operating from a DC bus can do this. If the inductor is part of an R-L-C circuit, rapid start ignition currents, maximum intensity, and dimming currents are easily controlled depending on the driving frequency versus resonant frequency.

A ballast should include a power factor corrector (PFC) to keep the main current and voltage in phase with a very low distortion over a wide range of 90 to 265 VAC 50/60 Hz. With microcontroller control, economical remote analog or digital control of lamp function and fault reporting are a reality. Moreover, adjusting the lamp power to correspond with human perceived light level is possible. An application specific microcontroller brings the designer the flexibility to increase performance and add features to the lighting product. Some of the possible features are described here in detail. The final design topology is shown in the block diagram of Figure 2-1.

Now, a new way of dimming fluorescent lamps fills the incandescent/fluorescent feature gap plus adds many additional desirable features at a very reasonable cost.

1.1 General Description

Fluorescent ballast topology usually includes line conditioning for CE and UL compliance, a power factor correction block including a boost converter to 400 V for universal input applications and a half bridge inverter. By varying the frequency of the inverter, the controller will preheat the filaments (high frequency), then ignite the lamp (reducing the frequency). Once the lamp is lit, varying the frequency will dim the light. The Atmel AT90PWM2B/216 microcontroller can be programmed to perform all of these functions.

Figure 1-2. Ballast Demonstrator Board

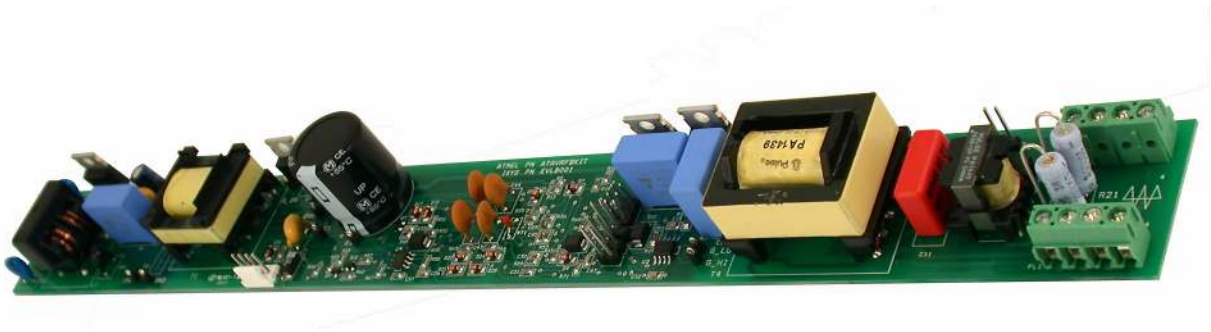

1.2 Ballast Demonstrator Features

- Automatic microcontroller dimmable ballast
- Universal input – 90 to 265 VAC 50/60 Hz, 90 to 370 VDC
- Power Factor Corrected (PFC) boost regulator
- Power feedback for stable operation over line voltage range
- Variable frequency half bridge inverter
- 18W, up to 2 type T8 lamps
- Automatic dimmable single lamp operation
- Automatic detection of Swiss or DALI
- Very versatile power saving options with microcontroller design for most functions



Section 2

Ballast Demonstrator Device Features

- 2.1 Atmel Supported Products**
- AT90PWM2B/216** Microcontroller
- High speed comparator for PFC zero crossover detection
 - 6 Analog inputs for A/D conversion, 2.56V reference level
 - 3 Digital inputs used for the dimming control input
 - 3 High speed configurable PWM outputs used for the PFC and half bridge driver
 - A fully differential A/D with programmable gain used for efficient current sensing
 - SOIC 24 pin package
 - Low power consumption in standby mode
-
- 2.2 IXYS® Supported Products**
- IXI859** Charge pump with voltage regulator and MOSFET driver
- 3.3V regulator with undervoltage lockout
 - Converts PFC energy to regulated 15VDC
 - Low propagation delay driver with 15V out and 3V input for PFC FET gate
- IXTP3N50P** MOSFET
- 500V, low R_{ds} (ON) power MOSFET, 3 used in design
- IXTP02N50D** depletion mode MOSFET
- 500V, 200mA, normally ON, TO-220 package and configured as current source
- IXD611S** MOSFET driver
- Up to 600mA drive current
 - half bridge, high and low side driver in a single surface mount IC
 - Undervoltage lockout

LDA111S Optocoupler (by Clare Inc., an IXYS company)

- 100mA continuous load rating
- 3750V_{RMS} input to output isolation

Figure 2-1. Ballast Demonstrator Block Diagram

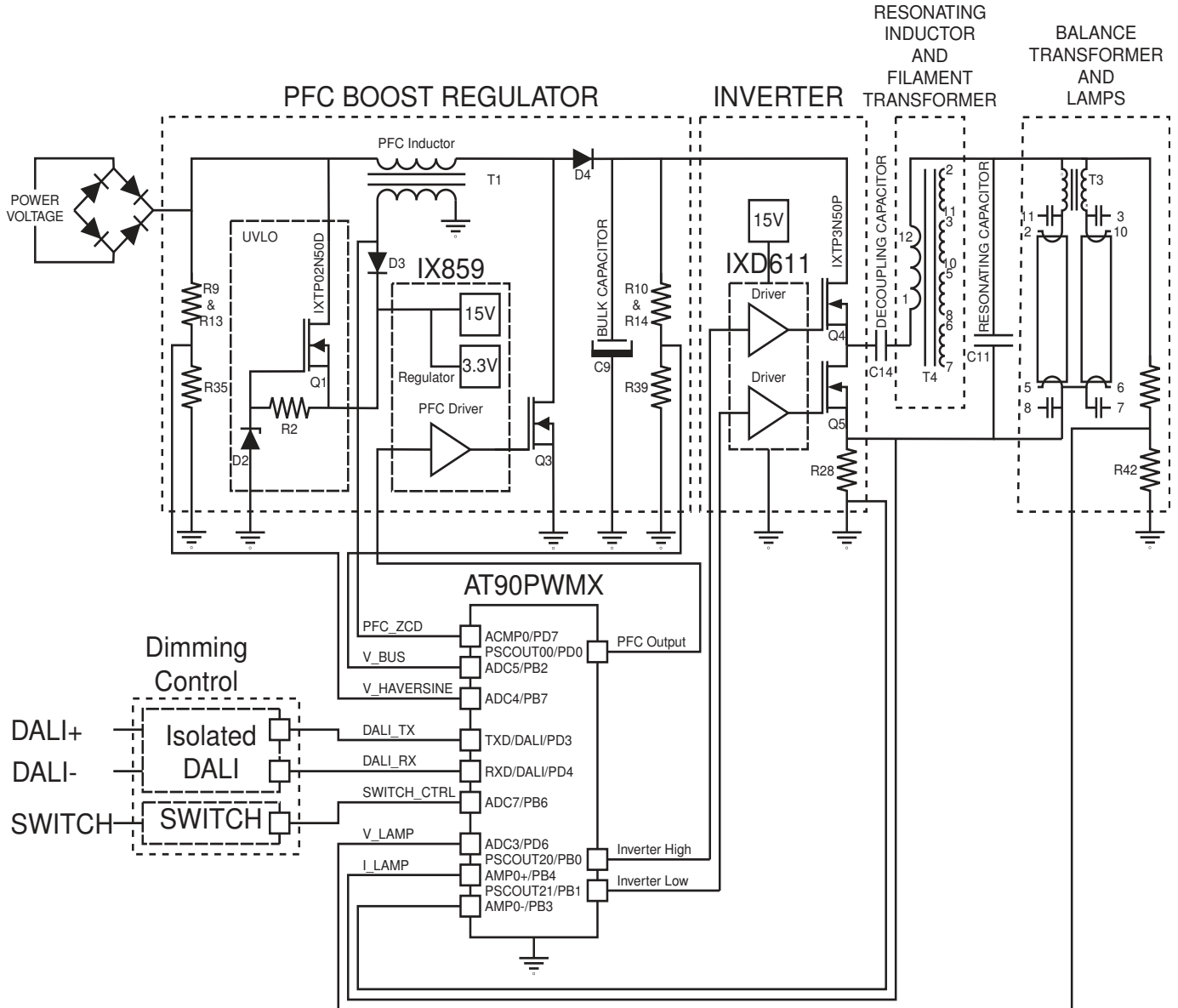



Section 3

Microcontroller Port Pin Assignments

PD0	PCOUT00	PFC_OUTPUT - To IXI859 FET driver input
PD1	PSCIN0	DUAL_LAMP - Dual lamp detection
PD3	TXD/DALI	DALI_TX - DALI transmit line
PD4	RXD/DALI	DALI_RX - DALI receive line
PD5	ADC2	LAMP_EOL - Not supported in hardware nor software
PD6	ADC3	V_LAMP - Rectified lamp voltage sense, missing lamp, open or shorted filament, preheat, ignition & run.
PD7	ACMP0	PFC_ZCD - Comparator for PFC zero current crossing sense
PB0	PSCOUT20	INVERTER_L - Low side half bridge driver output
PB1	PSCOUT21	INVERTER_H - High side half bridge driver output
PB2	ADC5	V_BUS - 400VDC bus voltage sense for regulation.
PB3	AMP0-	GND - Diff amp - A/D, 1 ohm bus current shunt resistor
PB4	AMP0+	I_LAMP - Diff amp + A/D
PB5	ADC6	TEMPERATURE - Ambient temperature in lamp housing
PB6	ADC7	SWITCH_CTRL - SWITCH Control input
PB7	ADC4	V_HAVERSINE - Haversine input sense.
PE0	RST#	RESET - Reset pin for zero crossing detector
PE1	PE1	XTAL1
PE2	ADC0	XTAL2



Section 4

Ballast Demonstrator Operation

4.1 General Requirements

- Constant power as determined by DALI or Switch Control
400 volt DC bus as provided by a power factor correcting boost regulator (PFC)
100% to 2% dimming setting
- One or two lamps, type T8 of 18W
Ballast to compensate automatically
Hardware is capable of up to 40W per lamp
- Line voltage of 90 to 265 VAC, 50 or 60 Hz
- Control method
DALI power control – auto recognition of control means
One touch “Switch” dimming 100% ON after ignition then dim to the last or current programmed value, if any.

4.2 Startup features

Software based features that are not fully implemented.

End users are invited to develop features based on the following characteristics.

- Auto re-strike
 - Missing lamp detection allows a default power of 100% on the remaining lamp with no dimming.
 - Open filament detection for one or two lamps as determined by combination of 400VDC current plus lamp voltage prior to ignition.
 - On board physical jumper to set for one or two lamp normal operation.
- Shorted filament
 - Detection by voltage sense across lamp during preheat. 400VDC current monitor detects over current limit upon startup. The microcontroller will sense the expected DC current to the half bridge and resonant circuit relative to the drive frequency.

- 4.3 Circuit Topology** Input filter with varistor for noise suppression and protection.
 PFC / boost circuit including IX1859 MOSFET driver
 AT90PWM2B/216 microcontroller 24 pin SOIC
 half bridge driver
 half bridge power MOSFET stage for up to 2 lamps
 Voltage driven filaments for wider lamp variety and better stability under all conditions
 400VDC bus voltage after the PFC boost

4.4 Startup and PFC Description

Upon application of main power, the microcontroller does not drive the PFC MOSFET Q3. The C9 capacitor is charged to the peak line voltage.

The depletion FET Q1 and the Zener Diode provide a DC voltage with enough current to supply the control portion of the ballast.

As soon as the microcontroller requests the ballast to start, the PFC is enabled according to the following sequence.

The microcontroller checks that the DC bus voltage is 90% of the haversine peak and the under voltage lockout (UVLO) requirements are met, then a series of fixed width soft-start pulses are sent to the PFC MOSFET (Q3) at 10 μ S at a 20 kHz rate. At very low load currents the bus voltage should rise to 400V. If the bus rises to 415 VDC all PFC pulses stop. As the 400V drops, the zero crossing detector PD7 starts to sense a zero crossing from the PFC transformer secondary. A 400V DC bus and a zero crossing event start the PFC control loop.

Checks are made to detect the presence of the rectified power (haversine) and bus voltage throughout normal operation. Main supply voltage senses at PB7 < 0.848 (90 VAC) or > 2.497 (265 VAC) peak faults the PFC to off, turns off the PFC MOSFET (Q3) and initiates a restart.

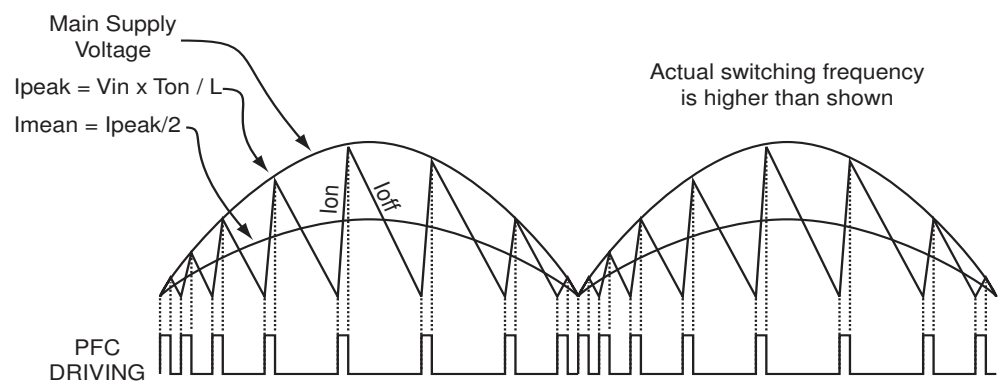

The control consists of measuring the error between VBUS and 400V (2.39V at PB2) to determine the PFC drive pulse width (PW). The PW is proportional to the error, and has to be constant over a complete half period. The update is done each time the haversine reaches zero.

The maximum current the PFC MOSFET (Q3) can sustain is 4.5A. The relation between PW and the peak current in PFC MOSFET (Q3) is:

$$PW = t = L \times I_{pk} / V_{\text{haversine_max}}$$

With L at 700 μ H and I_{pk} at 4.5A, PW_{max} = 8.5 μ S at high line (265 Vrms).

With L at 700 μ H and I_{pk} at 4.5A, PW_{max} = 24.7 μ S at high line (90 Vrms).

This also effectively limits the FET dissipation under upset conditions. Under normal operation, a pulse width maximum of 25 μ S is allowed for a maximum bus voltage error with the high line limitation. Regulation of 1% of the VBUS is achieved with this control scheme.

After the PFC FET ON pulse, the PFC inductor flyback boosts the voltage through the PFC diode to the bulk filter capacitor. The boost current decays as measured by the inductor secondary. After the current goes to zero, the next pulse is started. This ensures operation in a critical conduction boost mode. The current zero crossing detection of PD7 sets the PFC off time. This off time is effectively proportional to the haversine amplitude with the lowest PFC frequency occurring at the haversine crest and the highest frequency at the haversine zero. Because of the haversine voltage and $di = v \cdot dt / L$, the mains current envelope should follow the voltage for near unity power factor. This assumes a nearly constant error (di) of the DC bus over each haversine period.

The PFC ON time is modified proportionally to the error between 400V and the actual value of the bus. In case the Vbus reaches the overshoot value of 415V the pulse is reduced to 0.

This control loop will determine the regulation response to ripple current on the 400V bulk filter cap and the loads for a specific application design requirements.

4.4.1 System Sequential Step Description

Main voltage applied.

Undervoltage lockout (UVLO) released.

IX1859 voltage regulator supplies 3.3V to microcontroller.

Power microcontroller ON in low current standby mode.

Disable half bridge drive output PB0 & PB1

Disable PD5 comparator (Not implemented).

PB7, scaled haversine voltage must be >0.848 V_{min} (90VAC) & <2.497 (265VAC) V_{max} (haversine peak) for the PFC to start.

PD0 soft start PFC with 10 μ S pulses at 50 μ S period for 800 μ S.

Monitor comparator at PD7 for change 1 to 0 indicating a zero crossing of the PFC inductor secondary voltage. This occurs after the 10 μ S start pulse burst.

If no PD7 change and after 800 μ S halt PD0, wait 1 second and provide again PD0 with 10 μ S pulses for 800 μ S. Try 10 times and if no crossing, set PFC alarm.

After PD7 comparator transition and 400VDC (2.368V at PB2), enable PFC control loop.

- Adjust PB2 (400VDC sense) setpoint to 2.368V with deadband.

- If PB2 > 2.50V then inhibit PD0 pulse.

- If PB2 = < 2.368V then use the control loop to establish the PD0 PFC pulse width.



Limit pulse width to 25uS or as determined by the haversine peak voltage.

The adjustment of the PFC T_{ON} and T_{OFF} is down as follows:

- The T_{OFF} is automatically adjusted by hardware at each PFC inductor current zero crossing detection,
- The T_{ON} is adjusted by software accordingly to the V_{out} measurement each time the main supply voltage reach zero (Each half period of the main voltage supply)..

4.5 Lamp Operation Description

T4 primary and C11 form a serial resonant circuit driven by the output half bridge. Since the output is between 400V and 0V, DC isolation is provided by C14 to drive the lamp circuit with AC. The lamp is conected in parallel of the resonating capacitor C11 (But there is no current through the lamp). The lamp filaments are driven by windings on T1 secondaries to about 3Vrms so that the resonating inductor current provides the starting lamp filament current.

Initially, the system is set up at 80KHz, a frequency well above resonance the frequency then ramps down to 55 kHz for ignition. 80 kHz provides a lagging power factor where most of the drive voltage appears across the inductor. A smaller voltage appears across the resonating capacitor C11 and the lamps. However with 1 mH gapped inductance, there is sufficient inductor current to heat the filaments.

For lamp ignition, the frequency is decreased from 80 kHz to 40 kHz with 30 kHz/sec slope towards resonance causing the lamp voltage to rise to about 340V peak. Ignition occurs at about 40 kHz for a 18W T8 lamp. The plasma established in the lamp presents a resistive load across the resonating capacitor thereby reducing the voltage across the capacitor and shifting the reactive power in the bridge circuit to resistive power in the lamp.

A further reduction in frequency to 32 kHz at 30 kHz/sec establishes maximum brightness as the resonant circuit now has a leading (capacitive) power factor causing more voltage and current (approx. 360 Vpeak) across the capacitor and the lamp.

Dimming is accomplished by raising the drive frequency towards 100 kHz. The lower lamp (capacitor) voltage caused by changing from a leading to a lagging (inductive) power factor and the resulting drop in lamp current causes lamp dimming. The visual perception of brightness is logarithmic with applied power and must be taken into account in the control method scheme.

4.5.1 Single Lamp Operation

Not implemented.

Single lamp operation can be detected from the 400VDC bus current through a 1 ohm sense resistor sensed by the differential input PB3/PB4. The AT90PWM2B/216 differential amplifier has the gain preset in the source code at 10. This scales the 200mV for two lamps to a reasonable A/D resolution. PB4 requires low pass filtering. Through the 1 ohm sense resistor R28, $V = I * R = 80 \text{ Watts} * 1/400V = 200mA * 1 = 200mV$. At preheat, the current for one lamp is half of that for two lamps. This current is also used to sense open filament condition or lamp removed under power condition. An abrupt change in

the bus current is a good indicator of lamp condition that does not require a high frequency response or a minimal response due to reactive currents.

Once the single lamp condition is detected, the minimum run frequency is determined by lamp current $PB4 < 100mV$. If the single lamp condition occurs while running, as noted by a decrease in current of more than 20% from the preset level, increase the frequency until the $PB4 = 90mV$. If the $PB4$ increases to $120mV$, assume the lamp has been replaced by a new one. Increase the frequency to 80 kHz to restart the ignition process. This is necessary to preheat the new lamp filament to ensure that the hot lamp will not ignite sooner than the cold lamp, exceeding the balance transformer range. Start the ignition sequence. With one cold lamp in parallel with one hot lamp, it may be necessary to restart several times to get both lamps to ignite.

Note that the lamp and resonant circuit use a common return ground separate from the rest of the circuit. The ballast demonstrator uses active power feedback of the sense voltage versus drive frequency to meet power objectives. Also note that the differential amplifier is connected across the current sense resistor R28 to ensure a Kelvin connection. Layout of the amplifier + and – is critical for fast noise free loop response.

4.5.2 Lamp Sequential Step Description

After $PB2$ (boost voltage at 400V) $\geq 2.400V$ (across R42) start preheat
Enable PD6 rectified lamp voltage sense
Enable PB0 and PB1 half bridge drive output
 $PB0$ & $PB1$ 12.5 μ S total period (80 kHz) 50% duty 180° out of phase.
Check $PB4 > 20mV$, then 2 lamps. If $PB4 < 20mV$, assume a single lamp.
If $PB4 < 10mV$, assume an empty fixture = fault & shutdown.

Determine the lamp intensity control method: DALI (presence of data stream at PD4), or Switch (presence of 50/60 Hz modulated at PB6).

4.5.3 Start and Ignition Sequential Step Description

Sweep $PB0$ and $PB1$ frequency down at 30 kHz/sec or 33 μ S/sec rate.
Stop sweep at 40 kHz or 25 μ S period (12.5 μ S pulses for each half bridge FET)
Check $PB4 > 100mV$ (2 lamps) or $> 30mV$ (1 lamp) for proof of ignition.
Hold ignition frequency for 10mS.
If no PD6 voltage, collapse to $< 200mV$ for proof of ignition, increase frequency to 77 kHz for preheat for 1 second.
Repeat ignition sequence 6 times then if fails, set DALI fail flag or shut down.
Disable if dimmed frequency > 60 kHz. Disable if single lamp.
Proceed to power setting command at 30 kHz/sec rate as established by external control or if no internal control proceed to $PB4$ 195mV at input terminals before gain (about 32 kHz) for 100% power.
If Switch control, proceed to max power. A continuous pressing of this switch will cause a progressive increase of frequency at 33 kHz per second. The exception for a single lamp will be minimum frequency for 97mV (39 watts) at $PB4$ for 100% brightness. This is the default power for a single lamp with no dimming.

4.5.4 Power Control Description

Calculate input power for both lamps = PB4 (lamp current) * (lamp voltage). Use this data for DALI feedback verification if required. Set programmable gain of AMP0 to 10. 78 watts will be 0.195 VDC at the input of AMP0+ or 1.95V internal A/D input.

Adjust frequency up (lower power) or down (higher power) at 30KHz/sec rate. Limit frequency to 100% (PB4 = 0.195V and 32KHz) to 80KHz dimming range. The dimming must be logarithmic for the best resolution. The largest lumen change will be at the lowest power setting. A small high frequency change 70 to 80kHz will give a large perceived dimmed range.

If PB4 > 0.220V for two lamps or > 0.110V for one lamp, set half bridge drive off to avoid an over current. Start re-ignition sequence. Repeat 6 times and if still out of the limit, set TX DALI fail signal & shutdown PFC and half bridge drive.



Section 5

Device Design & Application

-
- 5.1 Magnetics** PFC – Power Factor Correction
Without going into the derivations of the formulae used, the inductor design is as follows:
- $$L = \frac{1.4 * 90VAC * 25\mu S}{4.5A \text{ peak}} = 700\mu H$$
- The ON time has been discussed earlier and the OFF time maximum will occur at high line condition at the peak of the haversine. A 16mm core was chosen for the recommended power density at 200mT and 50 kHz.
-
- 5.2 IXYS IXTP02N50D DEPLETION MODE MOSFET USED AS CURRENT SOURCE** The IXYS IXTP02N50D depletion mode MOSFET is used in this circuit to provide power and a start-up voltage to the Vcc pin of the IXI859 charge pump regulator. The IXTP02N50D acts as a current source and self regulates as the source voltage rises above the 15V zener voltage and causes the gate to become more negative than the source due to the voltage drop across the source resistor (R2). Enough energy is available from the current source circuit during the conduction angles to keep the IXI859 (U1) pin 1 greater than 14VDC as required to enable the Under Voltage Lock Out (UVLO) circuitry in the IXI859.
-
- 5.3 IXYS IXD611 Half- bridge MOSFET driver** The IXD611 half bridge driver includes two independent high speed drivers capable of 600mA drive current at a supply voltage of 15V. The isolated high side driver can withstand up to 650V on its output while maintaining its supply voltage through a bootstrap diode configuration. In this ballast application, the IXD611 is used in a half bridge inverter circuit driving two IXYS IXTP3N50P power MOSFETs. The inverter load consists of a series resonant inductor and capacitor to power the lamps. Filament power is also provided by the load circuit and is wound on the same core as the resonant inductor. Pulse width modulation (PWM) is not used in this application, instead the power is varied and the dimming of the lamps is controlled through frequency variation. It is important to note that pulse overlap, which could lead to the destruction of the two MOSFETs due to current shoot through, is prevented via the input drive signals through the microcontroller(500nS deadtimes).

Other features of the IXD611 driver include:

- Wide supply voltage operation 10-35V
- Matched propagation delay for both drivers
- Undervoltage lockout protection
- Latch up protected over entire operating range
- +/- 50V/ns dV/dt immunity

5.4 IXYS IXI859 Charge Pump Regulator

The IXI859 charge pump regulator integrates three primary functions central to the PFC stage of the ballast demonstrator. First it includes a linear regulated supply voltage output, and in this application the linear regulator provides 3.3V to run the microcontroller. The second function is a gate drive buffer that switches an external power MOSFET used to boost the PFC voltage to 400V. Once the microcontroller is booted up and running, it generates the input signal to drive the PFC MOSFET through the IXI859 gate drive buffer. Finally, the third function provides two point regulated supply voltage for operating external devices. As a safety feature, the IXI859 includes an internal Vcc clamp to prevent damage to itself due to over-voltage conditions.

In general applications at start-up, an R-C combination is employed at the Vcc supply pin that ramps up a trickle voltage to the Vcc pin from a high voltage offline source. The value of R is large to protect the internal zener diode clamp and as a result, cannot supply enough current to power the microcontroller on its own. C provides energy to boot the microcontroller. At a certain voltage level during the ramp up, the Under Voltage Lock Out point is reached and the IXI859 enables itself. The internal voltage regulator that supplies the microcontroller is also activated during this time. However, given the trickle charge nature of the Vcc input voltage, the microcontroller must boot itself up and enable PFC operation to provide charge pump power to itself. This means that the R-C combination must be sized carefully so that the voltage present at the Vcc pin does not collapse too quickly under load and causes the UVLO circuitry to disable device operation before the microcontroller can take over the charge pump operation. Also note that there is an internal comparator that only releases charge pump operation when the Vcc voltage drop below 12.85V. The charge pump is released and Vcc voltage is pumped up to 13.15V at which time the internal comparator disables the charge pump. This results in a tightly regulated charge pump voltage.

One problem with the R-C combination described above is that when a universal range is used at the Vcc pin, 90-265VAC, R must dissipate nine times the power, current squared function for power in R, over a three-fold increase of voltage from 90V at the low end to 265V on the high end. As an alternative and as used in the ballast demonstrator, the Vcc pin is fed voltage by way of a constant current source as previously described in Section 5.2. This circuit brings several advantages over the regular R-C usage. First we can reduce power consumed previously by R and replace it with a circuit that can provide power at startup. It can also provide sufficient power to run the microcontroller unlike the R-C combination. This would be an advantage in the case that a standby mode is desired. Overall power consumption can be reduced by allowing the microcontroller to enter a low power mode and shut down PFC operation without having to reboot the microcontroller. Since the R-C combination cannot provide enough power to sustain microcontroller operation, the microcontroller must stay active running the PFC section to power itself.



5.5 IXYS IXTP3N50P PolarHV™ N-Channel Power MOSFET

The IXTP3N50P is a 3A 500V general purpose power MOSFET that comes from the family of IXYS PolarHV MOSFETs. When comparing equivalent die sizes, PolarHT results in 50% lower RDS(ON), 40% lower RTHJC (thermal resistance, junction to case), and 30% lower Qg (gate charge) enabling a 30% - 40% die shrink, with the same or better performance versus the 1st generation power MOSFETs.

Within the ballast demonstrator itself the IXTP3N50 serves two functions. The first of which is the power switching pair of devices in the half-bridge circuit that drives the lamps. While a third device serves in the main PFC circuit as the power switch that drives the PFC inductor.

5.6 Clare LDA111S Optocoupler

Clare's family of single and dual optocoupler provide an optically isolated means of switching control circuits. The LDA111S contains one phototransistor that is optically coupled to an LED. Shunt resistors can be used to adjust the threshold currents required to activate the output circuitry. While both AC and DC input versions are available, the LDA111S is a DC input only model and features a 100mA continuous load rating, 3750V_{RMS} input to output isolation, and a 1000% current transfer ratio.

The LDA111S role is to isolate control signals within the ballast design.



Section 6

ATPWMX Demonstrator Software

This section of the application note describes the software architecture utilizing the following source code files and related state machines:

■ Main_fbkit.c

Initialisation of peripherals (Ports, ADC, timer...).

Clock pfc and lamp task each 200uS and let control task operating during free time.

■ Pfc_fbkit.c

PFC State Machine: executed each mS at low speed (1MHZ when the microller has not yet been speeded up), and each 200uS at nominal speed (8MHz).

■ Lamp_fbkit.c

Lamp State Machine: executed each 200uS.

■ Control_fbkit.c

Control State Machine: executed during CPU free time.

Associated header files:

- Main_fbkit.h
- Pfc_fbkit.h
- Lamp_fbkit.h
- Control_fbkit.h

The software uses the following peripherals:

- TIMER0, ADC, amplifier, Comparator0, PSC0, PSC2, PLL, DALI via EUSART

The application has been designed to work either with the AT90PWM2B/216 or 3B.

In order for the ballast to operate, three primary control systems should run simultaneously. One for the PFC control, one for the Lamp control, and one for the Command control of the ballast.

Since the software jitter was producing visible flickering, there is no more ADC state machine. Each analog conversion is done just before being used for control loops.

The complete software package for the application is split into the functional blocks in the diagram shown below. While the variables are identified as follows.

- g_ global
- gv_ global volatile
- gs_ global static

Voltage and current variables are identified by the following examples.

- g_v or g_i global - voltage/current
- gv_v or gv_i global volatile - voltage/current
- gs_v or gs_i global static - voltage/current

Figure 6-1. Demo Software Architecture

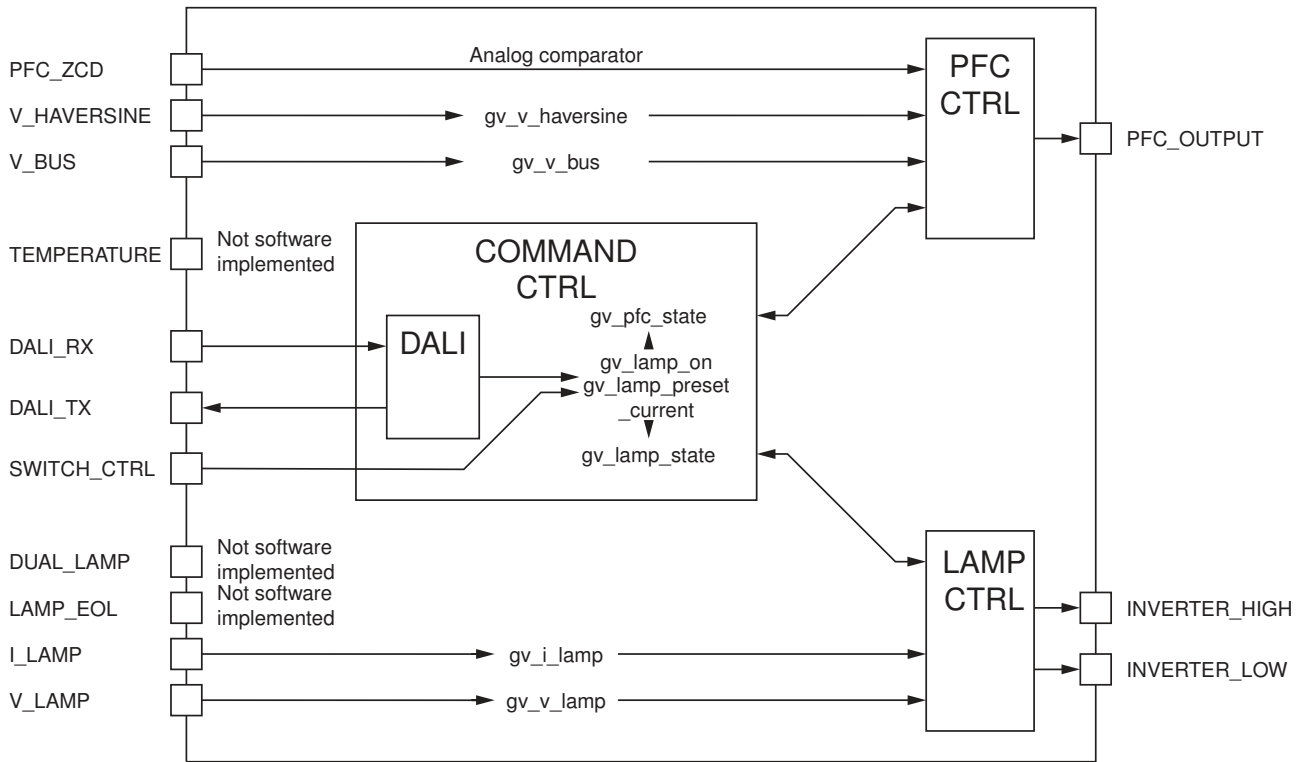

6.1 Main_pwm_x_fluo_demo.c This file executes all the peripheral initialization and then schedules the different control tasks.

The ADC and the Command control state machines are also included in this file. The ADC machine is controlled via interrupts.

6.1.1 COMMAND CONTROL STATE MACHINE The Command Control state machine centralizes the SWITCH and DALI controls in order to switch PFC operation On or Off and to set the lamp control instructions given by the user.

The Command Control state machine functional diagram is shown below:

Figure 6-2. Control State Machine

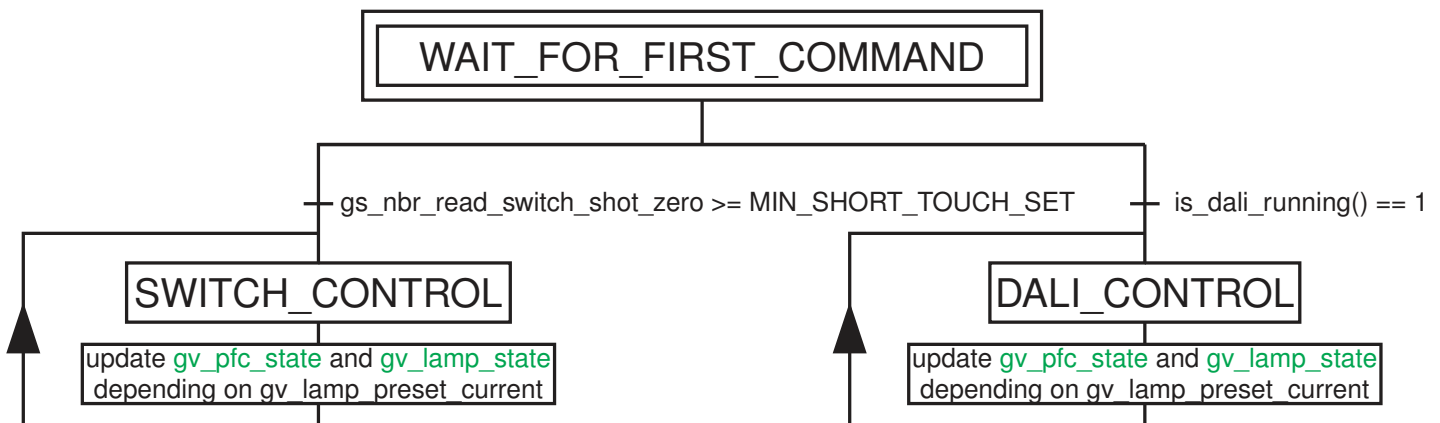

The different states are outlined below:

WAIT_FOR_FIRST_COMMAND

The three control means are scanned and the first command caught sets the state machine according to the command received. (SWITCH_CONTROL or DALI_CONTROL).

SWITCH_CONTROL

Read the input pin.

Analyze the touch dim command.

Set the control variable values corresponding to the user request.

DALI_CONTROL

Read the DALI Command.

Answer the request or set the control variable values corresponding to the DALI command.

6.1.2 Control state machine Global variables

6.1.2.1 Input variables which have an impact on the Control state machine

- `gv_lamp_on` is necessary to determine whether the lamp is already on or not.
- `g_too_many_ignition_tries` can be set in lamp state machine.

6.1.2.2 Output variables which can impact other state machines

- `gv_lamp_preset_current` is set to the wanted value and depending on the `gv_lamp_on` and `g_too_many_ignition_tries` values, `gv_lamp_state`, `gv_pfc_state` and `gv_lamp_on` can be set to the following values LAMP_OFF, SHUT_DOWN_PFC_AND_SLOW_DOWN_UC_SPEED, and 0 or 1.

6.2 Pfc_ctrl.c

This file executes the PFC state machine according to the scheduler in the Main_pwm_x_fluo_demo.c file.

6.2.1 PFC STATE MACHINE

The PFC state machine functional diagram is shown in Figure 6-3.

Figure 6-3. PFC State Machine

The different states are outlined below:

PFC_OFF

Nothing happens, the exit from this state is requested when the `gv_lamp_preset_current` variable is modified in control_FBKIT.c file.

INIT_PFC

Nothing happens, the state machine automatically goes to next step (INIT_PFC_HAVERSINE_CHECK) on the next pfc_task().

INIT_PFC_HAVERSINE_CHECK

Initialize the control values of the PFC.

Then jump to the HAVERSINE_CHECK state.

HAVERSINE_MEASURE

Measure the haversine peak voltage during HAVERSINE_MIN_CHECK_TIME.

Then jump to the HAVERSINE_CHECK state.

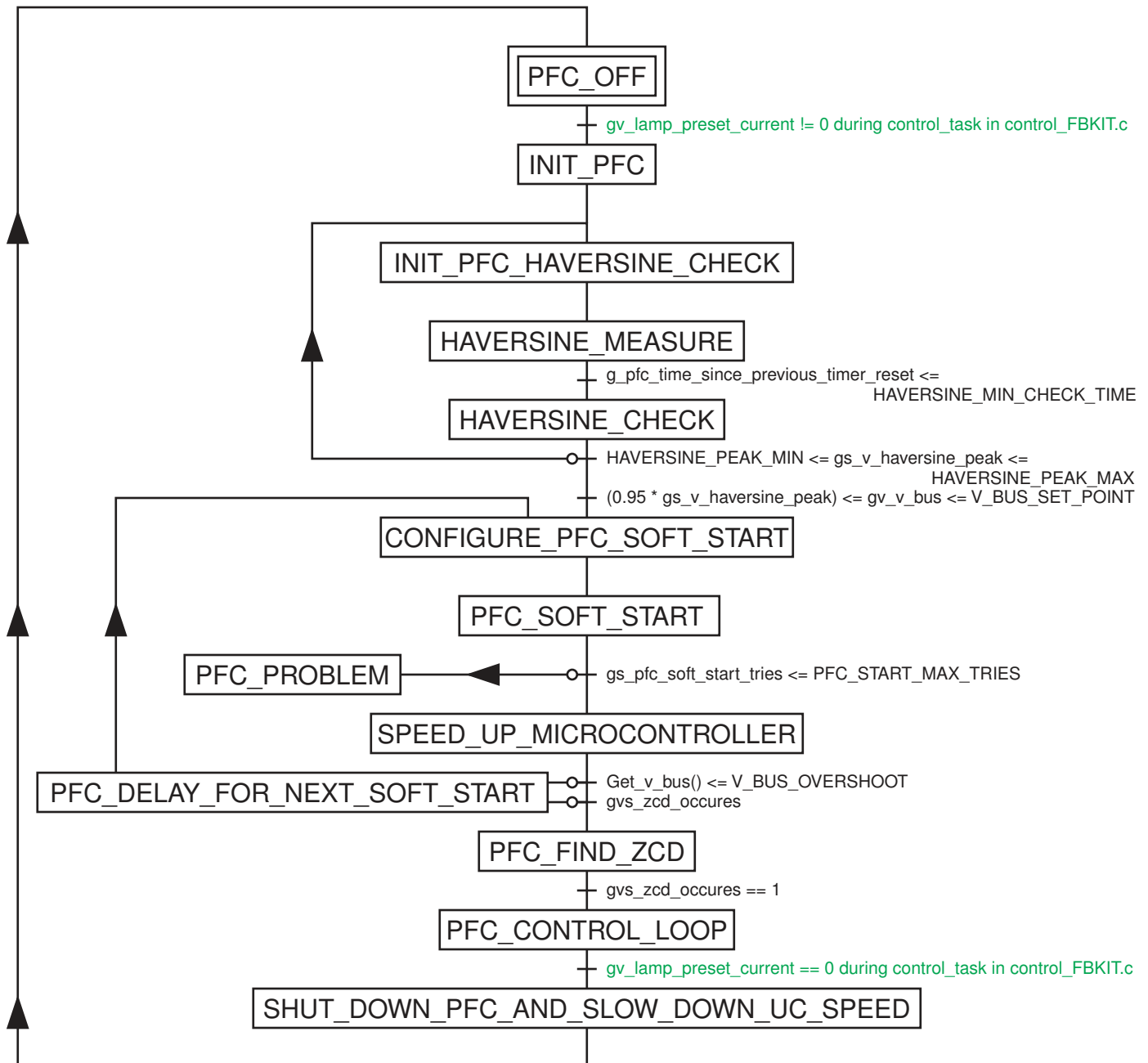
**HAVERSINE_CHECK**

PFC haversine peak must be between HAVERSINE_PEAK_MIN and HAVERSINE_PEAK_MAX (90VAC and 265VAC).

If the haversine value is OK, set the max pulse width allowed and jump to the CONFIGURE_PFC_SOFT_START state.

Else go back to INIT_PFC_HAVERSINE_CHECK state.

CONFIGURE_PFC_SOFT_START

Configures the peripherals PSC0 and comparator0 to soft start the PFC.

Then jump to START_PFC_SOFT_START.

START_PFC_SOFT_START

Check that the soft start has been tried less than PFC_START_MAX_TRIES

If OK then start PSC0 and jump to PFC_SOFT_START state.

Else immediately jump to the PFC_PROBLEM state.

PFC_SOFT_START

Check that the PFC has been tried to be set less times than PFC_START_MAX_TRIES.

According to this test, SPEED_UP_MICROCONTROLLER or jump to PFC_PROBLEM.

SPEED_UP_MICROCONTROLLER

In case a zero crossing detection happens, the PFC is switched on. The power will then be sufficient so that the microcontroller can be speeded up to its nominal speed, then it is necessary to find the zero crossing detection in the PFC_FIND_ZCD.

In case no zero crossing detection happens, a next try will be operate in PFC_DELAY_FOR_NEXT_SOFT_START.

PFC_DELAY_FOR_NEXT_SOFT_START

In case the soft start fails, the software has to wait DELAY_FOR_NEXT_PFC_SOFT_START*DELAY_MULTIPLIER_FOR_NEXT_PFC_SOFT_START, before trying a new soft start by going back to the CONFIGURE_PFC_SOFT_START state.

PFC_FIND_ZCD

Find the Zero Crossing Detection in order to start the PFC_CONTROL_LOOP on a zero crossing.

SHUT_DOWN_PFC_AND_SLOW_DOWN_UC_SPEED

Switch off the PFC.

Switch the microcontroller to a low power consumption mode.

Then go back to PFC_OFF state.

6.2.2 PFC State Machine
Global variables

6.2.2.1 Input variables which have an impact on PFC state machine

- `gv_lamp_preset_current` which is modified in `control_FBKIT.c` file makes the PFC state machine changing from `PFC_OFF` to `INIT_PFC` when the user request to switch the lamp on.
- `gv_pfc_state` is set to `SHUT_DOWN_PFC_AND_SLOW_DOWN_UC_SPEED` state on the `control_FBKIT.c` file when the user request to switch the lamp off.

6.2.2.2 Output variables which can impact other state machines

- None.

6.3 Lamp_ctrl.c

This file executes the Lamp state machine according to the scheduler in the `Main_pwmx_fluo_demo.c` file.

6.3.1 Lamp State Machine The different states are outlined below:

Figure 6-4. Lamp State Machine

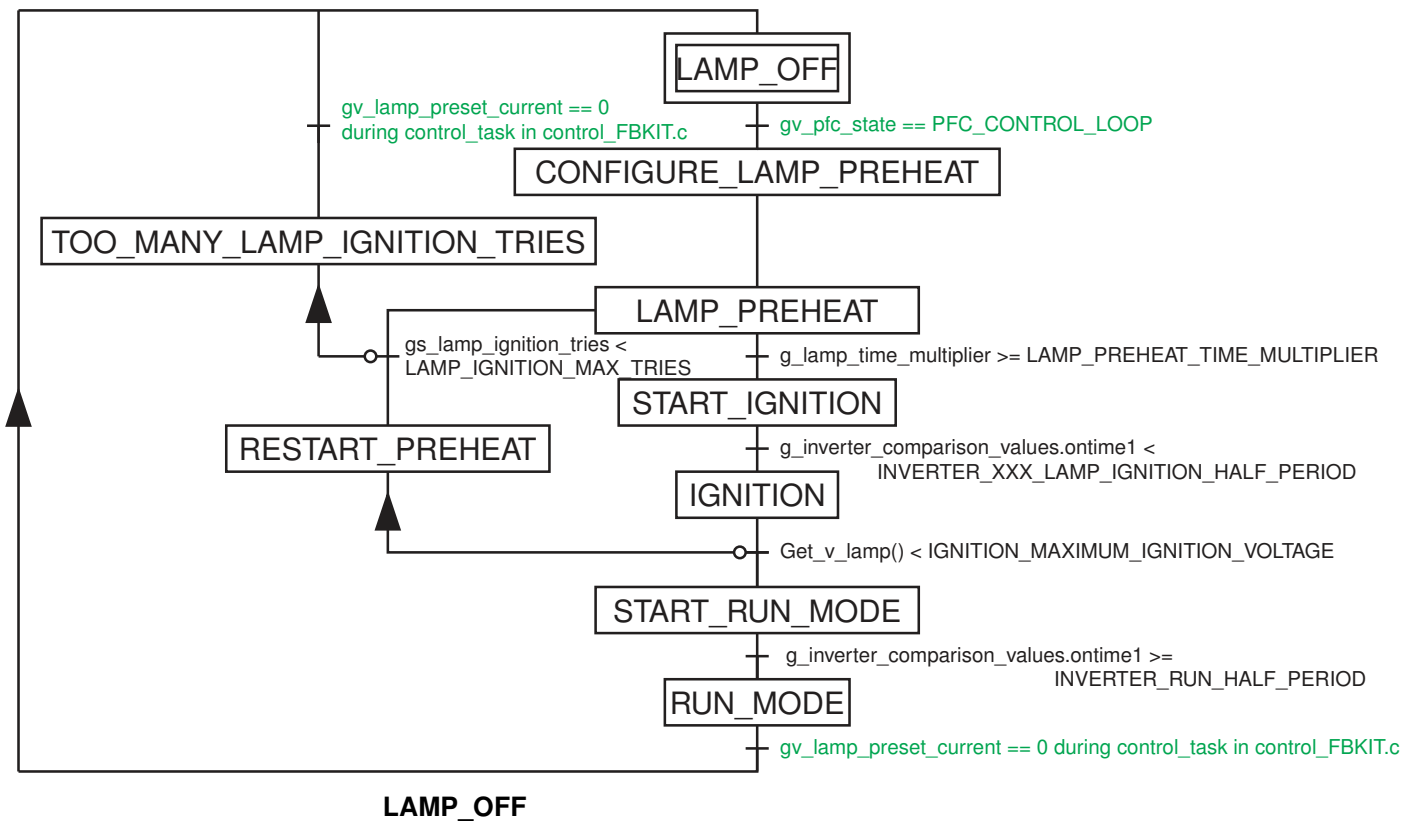

Nothing happens, the exiting of this state takes place as soon as the `gv_pfc_state` is set to `PFC_CONTROL_LOOP`.

CONFIGURE_LAMP_PREHEAT

This is the first time the lamp is attempted to be started once the user has requested to switch it on.

Configure the amplifier0, which is used to measure the current, then configure the PSC2 according to the definitions in the config.h file, and initialize all the lamp control variables.

Then jump to the LAMP_PREHEAT state.

LAMP_PREHEAT

Starts the preheat sequence for LAMP_PREHEAT_TIME. (PWM set up at 80KHz)

Then jump to the START_IGNITION state.

START_IGNITION

Decrease the frequency from the init frequency down to INVERTER_IGNITION_HALF_PERIOD.

Then jump to the IGNITION state.

IGNITION

The ignition sequence consists of maintaining the ignition frequency determined by INVERTER_IGNITION_HALF_PERIOD for 10ms, and then checking if ignition occurs by measuring lamp current and voltage.

In case it has... START_RUN_MODE.

In case it hasn't... RESTART_PREHEAT.

RESTART_PREHEAT

Reconfigure the Inverter with the Restart parameters, then go to LAMP_PREHEAT.

If Ignition fails too many times... Go to TOO_MANY_LAMP_IGNITION_TRIES.

START_RUN_MODE

Increase the frequency from the init frequency, INVERTER_IGNITION_HALF_PERIOD.

Then jump to the RUN_MODE state.

RUN_MODE

Normal control loop to have the light in accordance with the `gv_lamp_preset_current` variable that is permanently updated in the command control state machine in the Main_pwm_x_fluo_demo.c file.

The transition from the RUN_MODE state to the LAMP_OFF state is done in the control state machine (control_FBKIT.c file) when the `gv_lamp_preset_current` variable is set to 0.

TOO_MANY_LAMP_IGNITION_TRIES

If the ignition has failed LAMP_IGNITION_MAX_TRIES, `g_too_many_ignition_tries` variable will be set, and the lamp will be switched off thanks to `control_FBKIT.c` file which will switch off the ballast.

6.3.2 Lamp state machine Global variables

6.3.2.1 Input variables which have an impact on the Lamp state machine

- The transition from LAMP_OFF to CONFIGURE_LAMP_PREHEAT is done when the `gv_pfc_state` is set to PFC_CONTROL_LOOP in `PFC_FBKIT.c` file.
- The transition from the RUN_MODE state to the LAMP_OFF state is done in the Control state machine in the case `gv_lamp_preset_current` is equal to 0.

6.3.2.2 Output variables which can impact other state machine

- `g_too_many_ignition_tries == 1` makes the ballast switch off in the control state machine in `control_FBKIT.c` file.



Section 7

Conclusion

The ballast demonstrator shows that the AT90PWM2B/216 microcontroller can control and regulate fluorescent lamps from any of the two (DALI and switch) methods of dimming. It can automatically sense the control method used thereby providing lamp controller manufacturers with maximum flexibility in their design. One or more lamps can be controlled with flexibility and precision. Universal input and power factor control adds to the flexibility of the design with a minimal addition of more expensive active components.

Additionally, the programmability of the microcontroller offers the lamp manufacturer the flexibility to add more design features than are shown here to enhance their market position. The ballast demonstrator, although it has many features, does not address all the possibilities available to the lamp controller designer.

7.1 Appendix 1: SWITCH DIM

The switch DIM allows dimming control using a simple switch connected to the mains phase.

Switch DIM operation

The Switch DIM operation is as follows:

With the lamp switched on:

A short push switches the luminary off and stores the current light level.

A long push gradually dims the light level. (Change direction by briefly taking your finger off the button and pressing down again).

With the lamp switched off:

A short push switches the lamp on to the last light level used. (Optional: Use a soft start from minimum level to last level used).

A longer push starts on the last light level used and gradually raises the light level to the required brightness.

The lamps are dimmed for as long as the switch is pressed or until the minimum or maximum dimmer setting is reached.

**7.2 Appendix 2:
Capacitor
Coupled Low
Voltage Supply**

Small currents for the low voltage supply can be obtained from the AC line at low loss by means of capacitor coupling as shown in the figures below. To estimate the required size of the coupling capacitor, use the following relationships for current, charge, voltage and capacitance.

$$1. dQ/dt = I_{DC}$$

Figure 7-1. Negative Line Half Cycle

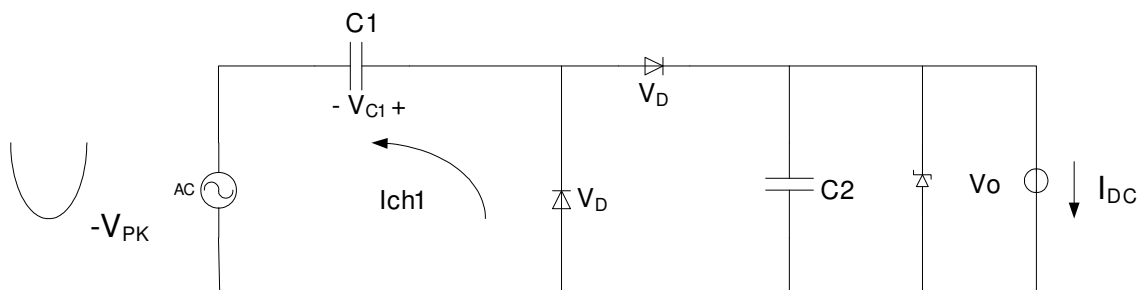

“Negative” line half-cycle:
C1 charges to $V_{pk} - V_D$ with polarity shown.

Figure 7-2. Positive Line Half Cycle

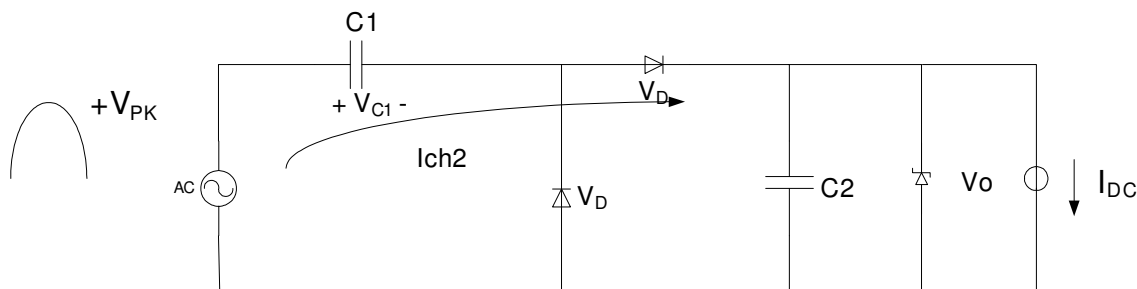

“Positive” line half-cycle:
C1 charges to $V_{pk} - V_D - V_o$ with polarity shown.

1. $dV = 2V_{pk} - V_o - 2V_D$
2. $dQ = CdV$ or $C = dQ/dV$

For example, to obtain 15 mA at 20 VDC from a 220 Vrms 50 Hz line:

1. $dQ/dt = (15 \text{ millijoules/sec}) / (50 \text{ cycles/sec})$ or 0.3 millijoules / cycle.
2. Over 1 cycle, the coupling capacitor (C1) will charge from $-220V \times 1.4$ to $+220V \times 1.4 - 20V - V_D$. $dV = 2*V_{pk} - V_o - 2V_D$. $dV \approx 600V$.
3. The required C1 $\sim 0.3 \text{ millijoules} / 600V$ or 0.5 uF

In practice, C1 may have to be larger depending on the amount of ripple allowed by C2 and to account for component tolerances, minimum voltage, and current in the regulator diode. C1 must be a non-polarized type with a voltage rating to withstand the peak line voltage including transients. A high quality film capacitor is recommended.

7.3 Appendix 3: PFC Basics

The function of the PFC boost regulator is to produce a regulated DC supply voltage from a full wave rectified AC line voltage while maintaining a unity power factor load. This means that the current drawn from the line must be sinusoidal and in phase with the line voltage.

The ballast PFC circuit accomplishes this by means of a boost converter operating (See Figure 7-3) at critical conduction so that the current waveform is triangular (See Figure 7-4).

Figure 7-3. PFC Boost Regulator

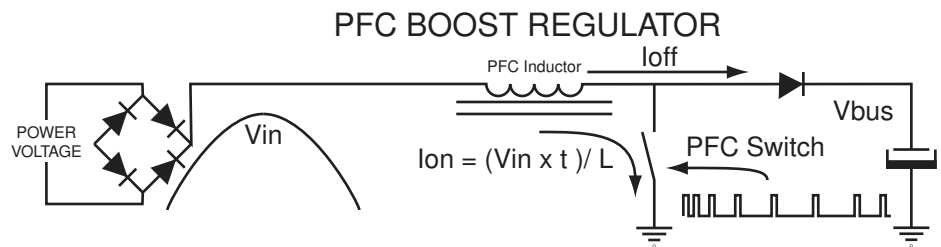

The boost switch ON time is maintained constant over each half cycle of the input voltage sinusoid. Therefore the peak current for each switching cycle is proportional to the line voltage which is nearly constant during T_{on} . ($I_{peak} = V_{in} \times T_{on}/L$). Since the average value of a triangular waveform is half its peak value, the average current drawn is also proportional to the line voltage.

Figure 7-4. Main voltage supply cutting

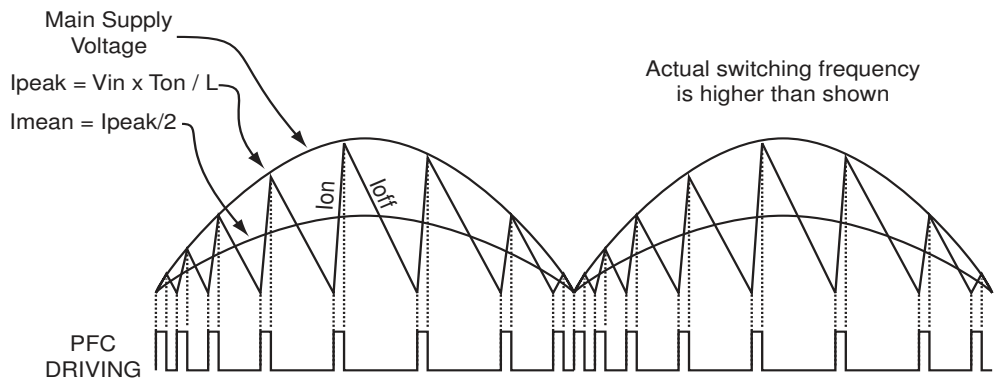

7.4 Appendix 4: Bill of Material *Figure 7-5.* Bill of Materials 1

Item	Quantity	Reference	Part	Manufactures Part #
1	1	BR1	600V	DF10S
2	1	BR2	0.5A 200V	RH02
3	2	C1,C3	1800 pF 250VAC	WYO182MCMBF0K
4	2	C2,C28	1nF 50V	ECJ-2VB1H102K
6	3	C4,C13,C14	.1uF 600V	MKP1840410634
7	2	C5,C42	1 nF 250VAC	ECK-NVS102ME
8	1	C6	47 uF	ECA-1JM470
9	3	C7,C29,C41	10uF 25V	T491C106K025AS
10	3	C8,C25,C35	1uF	GRM219F51E105ZA01D
11	1	C9	47uF 455V	ECO-S2WP470BA
12	2	C10,C46	.022 uF	ECJ-2VF1H223Z
13	1	C11	.01uF 1500V FILM	MKP100.01/2000/5
14	12	C12,C15,C23,C24,C26,C27, C30,C32,C33,C36,C40,C47	.1uF	GRM216F51E104ZA01D
15	2	C16,C17	4.7 nF 630V	ECJ-3FB2J472K
16	4	C18,C20,C21,C22	220nF 100V	ECJ-4YB2A224K
17	1	C19	.001uF	GRM2165C1H102JA01D
18	1	C31	100pF	ECJ-2VC1H101J
19	2	C37,C48	.01uF	GRM216R71H103KA01D
20	4	C38,C39,C43,C44	180 pF 1 KV	140-102S6-181J
21	5	D1,D4,D10,D15,D27	1A-600V/FR	MURS160-13
22	1	D2	15V Zener	MMSZ5245B-7-F
23	18	D3,D5,D7,D9,D11,D12,D14, D16,D17,D18,D19,D20,D21, D22,D24,D25,D26,D28	LL4148-13	LL4148-13
24	3	D6,D8,D13	MBRS140CT	MBRS140TR
25	1	D23	1n4740 10V Zener	MMSZ5240B-7
26	3	J1,FL1,FL2	CONNECTOR	1935187
27	4	ISO1,ISO2,ISO3,ISO4	LDA111S	CLARE LDA111S
28	4	JP2,JP3,J3,J4	JUMPER	929834-03-36
29	1	J2	HEADER6PIN	10-88-1121
30	1	J5	CON4	640456-4
31	1	L1	CM CHOKE	ELF-15N007A
32	1	Q1	IXTP02N50D	IXYS XTP02N50D
33	2	Q7,Q8	BC846BCT	BC847BLT1
34	3	Q3,Q4,Q5	IXTP3N50P	IXYS IXTP3N50P
35	3	Q6,Q9,Q10	BC857B	BC857BLT1
36	1	RT1	10K @ 25C	01C1002JP

Conclusion

Figure 7-6. Bill of Materials 2

Item	Quantity	Reference	Part	Manufactures Part #
37	1	RV1	VARISTOR265VAC	ERZ-V05D471
38	6	R9,R10,R13,R14,R25,R62	1M	
39	1	R2	18K	
40	3	R3,R64,R50	100 OHM	
41	6	R5,R26,R27,R52,R65,R66	1K	
42	1	R6	20K	
43	2	R21,R22	200 OHM 3 W	ERG-3SJ201
44	3	R12,R19,R23	27OHM	
45	1	R15	22K	
46	1	R18	100K 1/4W	
47	2	R20,R24	402K	
48	1	R28	1 /1%	
49	1	R29	1.2K	
50	1	R30	464 K	
51	2	R31,R32	200K	
52	1	R33	1.8 K	
53	5	R34,R40,R46,R51,R71	10K	
54	2	R35,R39	12K	
55	10	R36,R42,R44,R45,R48 R53,R55,R60,R63,R69	100 K	
56	2	R37,R68	22 OHM	
57	1	R38	2.2K	
58	1	R47	10 OHM	
59	1	R56	1.5K	
60	2	R54,R57	22 K	
61	2	R58,R67	43 K	
62	3	R41,R43,R59	4.7K	
63	1	R61	330 K	
64	2	TP1,TP2	TESTPT	5001
65	1	TP3	15V	5001
66	2	TP4,TP5	GND	5001
67	1	TP6	GATEDR	5001
68	1	TP7	VCC	5001
69	1	TP8	GATEHI	5001
70	1	TP9	GATELO	5001
71	1	T1	LPFC XFORM	Pulse Eng. PA1438
72	1	T3	BALANCE XFORM	Pulse Eng. PA1440
73	1	T4	TRANSFORMER	Pulse Eng. PA1439

Figure 7-7. Bill of Materials 3

Item	Quantity	Reference	Part	Manufactures Part #
74	1	U1	IXI859S1	IXYS IXI859S1
75	1	U2	IXD611S1	IXYS IIXD611S1
76	1	U3	AT90PWM2	Atmel AT90PWM2
77	1	U5	LMC555CM	LMC555CM
78	1	C45	47nF	GRM216E41H473MA01D
79	1	R49	470 OHM	
80	1	R70	0 OHM	
81	1	Q1 Heat Sink (Optional)	Heat Sink	530614B00000
82	1	R11 (Optional)	200 OHM 3 W	ERG-3SJ201
83	2	SH3, SH4	Jumper	STC02SYAN

7.5 Appendix 5: Schematics

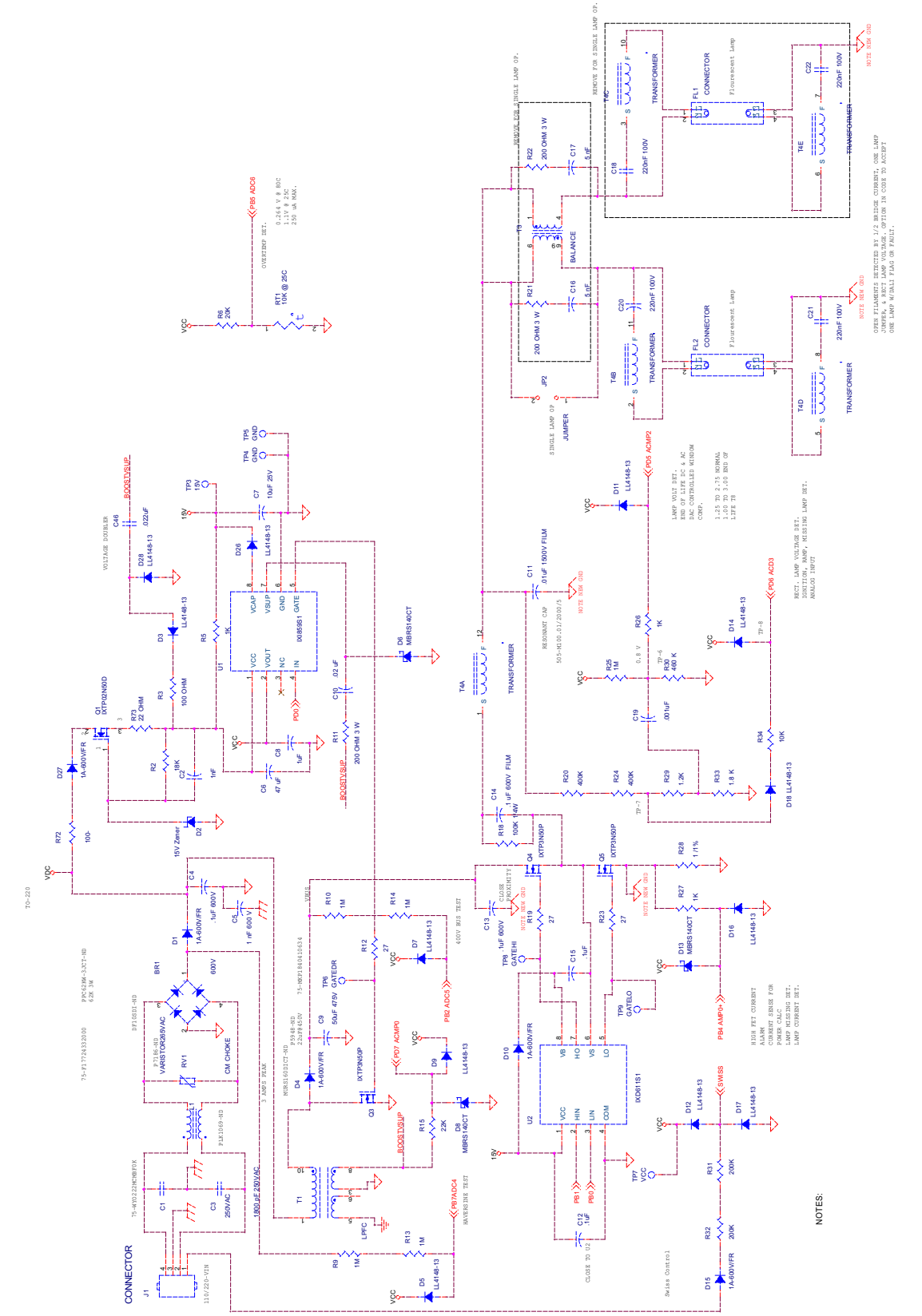

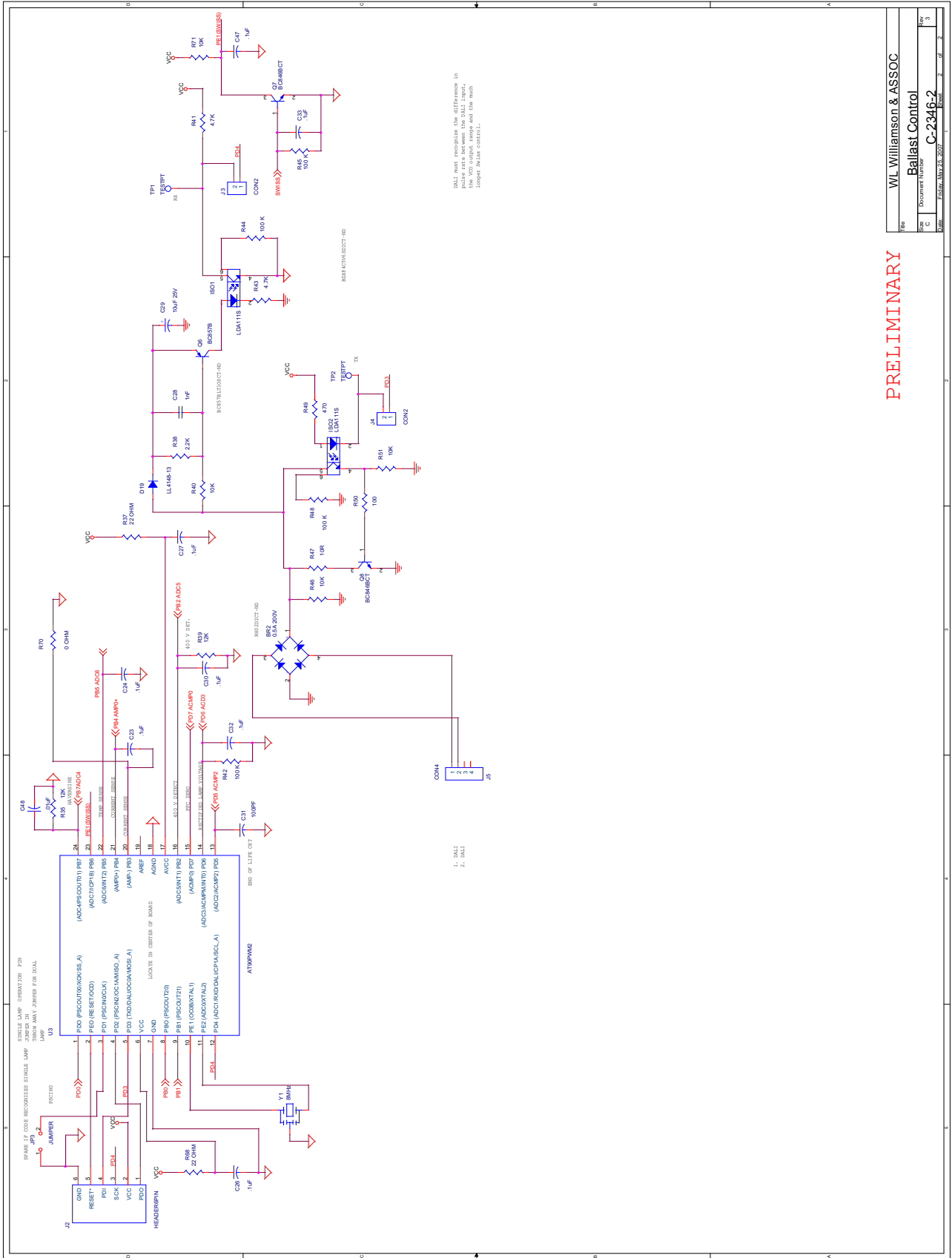

PRELIMINARY

File	WL-Williamson & ASSOC
Doc	Ballast Control
Doc Number	C-2346-2
Date	15/04/2007
Rev	1
Rev	2
Rev	3
Rev	4
Rev	5
Rev	6
Rev	7
Rev	8
Rev	9
Rev	10





Atmel Corporation

2325 Orchard Parkway
San Jose, CA 95131, USA
Tel: 1(408) 441-0311
Fax: 1(408) 487-2600

Regional Headquarters

Europe

Atmel Sarl
Route des Arsenalux 41
Case Postale 80
CH-1705 Fribourg
Switzerland
Tel: (41) 26-426-5555
Fax: (41) 26-426-5500

Asia

Room 1219
Chinachem Golden Plaza
77 Mody Road Tsimshatsui
East Kowloon
Hong Kong
Tel: (852) 2721-9778
Fax: (852) 2722-1369

Japan

9F, Tonetsu Shinkawa Bldg.
1-24-8 Shinkawa
Chuo-ku, Tokyo 104-0033
Japan
Tel: (81) 3-3523-3551
Fax: (81) 3-3523-7581

Atmel Operations

Memory

2325 Orchard Parkway
San Jose, CA 95131, USA
Tel: 1(408) 441-0311
Fax: 1(408) 436-4314

Microcontrollers

2325 Orchard Parkway
San Jose, CA 95131, USA
Tel: 1(408) 441-0311
Fax: 1(408) 436-4314

La Chantrerie
BP 70602
44306 Nantes Cedex 3, France
Tel: (33) 2-40-18-18-18
Fax: (33) 2-40-18-19-60

ASIC/ASSP/Smart Cards

Zone Industrielle
13106 Rousset Cedex, France
Tel: (33) 4-42-53-60-00
Fax: (33) 4-42-53-60-01

1150 East Cheyenne Mtn. Blvd.
Colorado Springs, CO 80906, USA
Tel: 1(719) 576-3300
Fax: 1(719) 540-1759

Scottish Enterprise Technology Park
Maxwell Building
East Kilbride G75 0QR, Scotland
Tel: (44) 1355-803-000
Fax: (44) 1355-242-743

RF/Automotive

Theresienstrasse 2
Postfach 3535
74025 Heilbronn, Germany
Tel: (49) 71-31-67-0
Fax: (49) 71-31-67-2340

1150 East Cheyenne Mtn. Blvd.
Colorado Springs, CO 80906, USA
Tel: 1(719) 576-3300
Fax: 1(719) 540-1759

Biometrics/Imaging/Hi-Rel MPU/ High Speed Converters/RF Datacom

Avenue de Rochepleine
BP 123
38521 Saint-Egreve Cedex, France
Tel: (33) 4-76-58-30-00
Fax: (33) 4-76-58-34-80

Literature Requests

www.atmel.com/literature

Disclaimer: The information in this document is provided in connection with Atmel products. No license, express or implied, by estoppel or otherwise, to any intellectual property right is granted by this document or in connection with the sale of Atmel products. **EXCEPT AS SET FORTH IN ATMEL'S TERMS AND CONDITIONS OF SALE LOCATED ON ATMEL'S WEB SITE, ATMEL ASSUMES NO LIABILITY WHATSOEVER AND DISCLAIMS ANY EXPRESS, IMPLIED OR STATUTORY WARRANTY RELATING TO ITS PRODUCTS INCLUDING, BUT NOT LIMITED TO, THE IMPLIED WARRANTY OF MERCHANTABILITY, FITNESS FOR A PARTICULAR PURPOSE, OR NON-INFRINGEMENT. IN NO EVENT SHALL ATMEL BE LIABLE FOR ANY DIRECT, INDIRECT, CONSEQUENTIAL, PUNITIVE, SPECIAL OR INCIDENTAL DAMAGES (INCLUDING, WITHOUT LIMITATION, DAMAGES FOR LOSS OF PROFITS, BUSINESS INTERRUPTION, OR LOSS OF INFORMATION) ARISING OUT OF THE USE OR INABILITY TO USE THIS DOCUMENT, EVEN IF ATMEL HAS BEEN ADVISED OF THE POSSIBILITY OF SUCH DAMAGES.** Atmel makes no representations or warranties with respect to the accuracy or completeness of the contents of this document and reserves the right to make changes to specifications and product descriptions at any time without notice. Atmel does not make any commitment to update the information contained herein. Unless specifically provided otherwise, Atmel products are not suitable for, and shall not be used in, automotive applications. Atmel's products are not intended, authorized, or warranted for use as components in applications intended to support or sustain life.

© Atmel Corporation 2007. All rights reserved. Atmel®, logo and combinations thereof, Everywhere You Are® are the registered trademarks or trademarks of Atmel Corporation or its subsidiaries. IXYS® logo and combinations thereof, are the registered trademarks or trademarks of Atmel Corporation or its subsidiaries. Other terms and product names may be trademarks of others.



Printed on recycled paper.

7597B-AVR-10/07