

# RSAL SERIES

Compact Multipurpose Type Compatible with High-Voltage Pulse

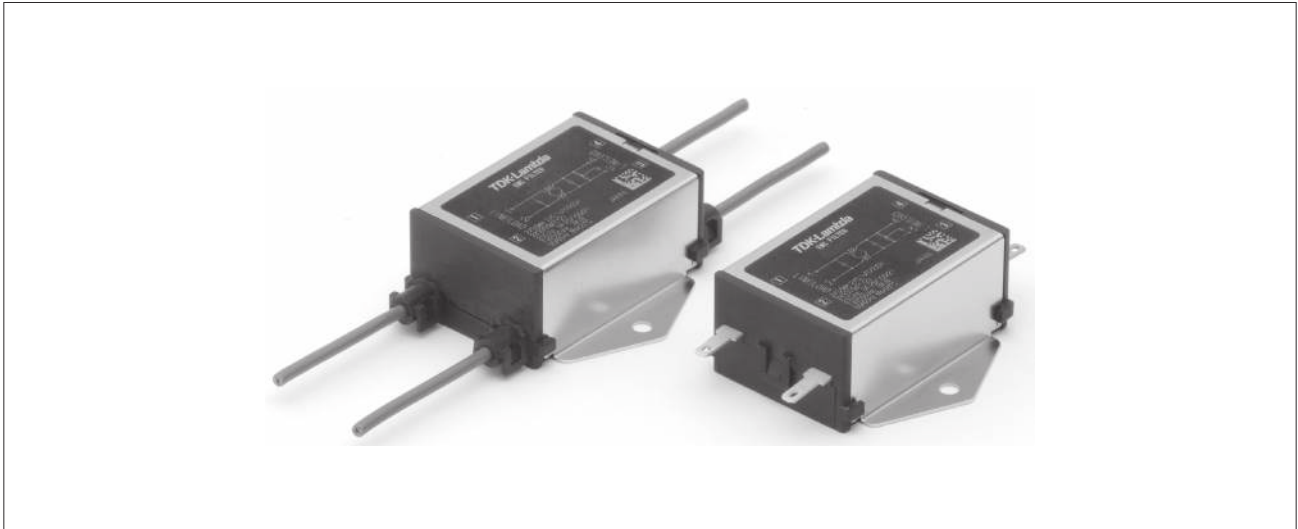

## FEATURES

- Amorphous core is used as the common mode coil core for the RSEL series, which helps prevent device errors.
- Wire type and lug terminal type are available with the same shape.
- Optional low-leakage characteristic type is also available.

## SAFETY STANDARDS

UL1283	UL File No. E62388
CSA C22.2 No.8	CSA File No. LR76849
EN60939-1/-2 (ENEC14)	Licence Ref. No. SE/07115-1

## PRODUCT IDENTIFICATION

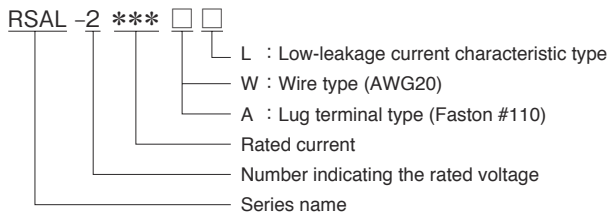

## CONFORMITY TO RoHS Directive

## CIRCUIT DIAGRAMS

RSAL-2 \*\*\* W  
RSAL-2 \*\*\* A

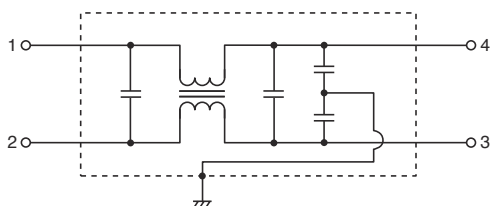

RSAL-2 \*\*\* WL  
RSAL-2 \*\*\* AL

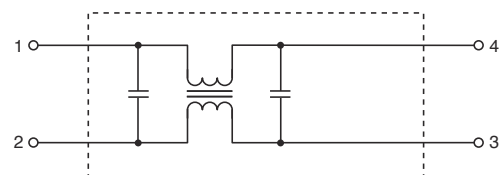

• Faston® is a registered trademark of TE Connectivity.

**ELECTRICAL CHARACTERISTICS**

Part No.	Rated voltage (AC/DC)	Rated current (AC/DC)	Withstand voltage	Insulation resistance	Leakage current	Operating temperature range	With derating over	DC resistance (mΩ)	Attenuation frequency range (MHz)		Weight (g)
									Common mode	Differential mode	
									at 25dB	at 25dB	
RSAL-20R5W	250V	0.5A	AC.2500V 60s [Between line to ground]	100MΩmin. [DC.500V/ 1min]	1.0mA max. [250V/60Hz]	-25 to +85°C	55°C	700 max.	0.3 to 8	0.4 to 30	58
RSAL-2001W		1A						600 max.	0.3 to 8	0.5 to 30	58
RSAL-2002W		2A						250 max.	0.5 to 8	0.7 to 30	61
RSAL-2003W		3A						150 max.	1 to 7	0.8 to 30	61
RSAL-2006W		6A						80 max.	3 to 7	1 to 30	61
RSAL-20R5A		0.5A						700 max.	0.3 to 8	0.4 to 30	43
RSAL-2001A		1A						600 max.	0.3 to 8	0.5 to 30	43
RSAL-2002A		2A						250 max.	0.5 to 8	0.7 to 30	46
RSAL-2003A		3A						150 max.	1 to 7	0.8 to 30	46
RSAL-2006A		6A						80 max.	3 to 7	1 to 30	46

Part No.	Rated voltage (AC/DC)	Rated current (AC/DC)	Withstand voltage	Insulation resistance	Leakage current	Operating temperature range	With derating over	DC resistance (mΩ)	Attenuation frequency range (MHz)		Weight (g)
									Common mode	Differential mode	
									at 15dB	at 25dB	
RSAL-20R5WL	250V	0.5A	AC.2500V 60s [Between line to ground]	100MΩmin. [DC.500V/ 1min]	10 μ A max. [250V/60Hz]	-25 to +85°C	55°C	700 max.	0.1 to 5	0.4 to 30	56
RSAL-2001WL		1A						600 max.	0.1 to 5	0.5 to 30	56
RSAL-2002WL		2A						250 max.	0.1 to 5	0.7 to 30	59
RSAL-2003WL		3A						150 max.	0.2 to 5	0.8 to 30	59
RSAL-2006WL		6A						80 max.	1 to 30	1 to 30	59
RSAL-20R5AL		0.5A						700 max.	0.1 to 5	0.4 to 30	41
RSAL-2001AL		1A						600 max.	0.1 to 5	0.5 to 30	41
RSAL-2002AL		2A						250 max.	0.1 to 5	0.7 to 30	44
RSAL-2003AL		3A						150 max.	0.2 to 5	0.8 to 30	44
RSAL-2006AL		6A						80 max.	1 to 30	1 to 30	44

**DERATING GRAPH**

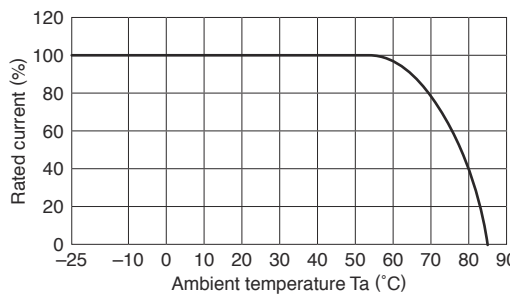

MECHANICAL

RSAL-20R5/2001/2002/2003/2006W(L)

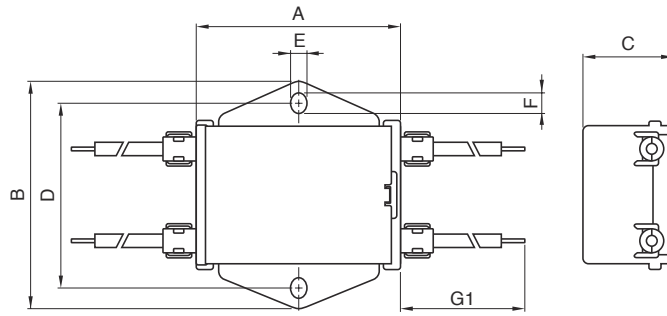

RSAL-20R5/2001/2002/2003/2006A(L)

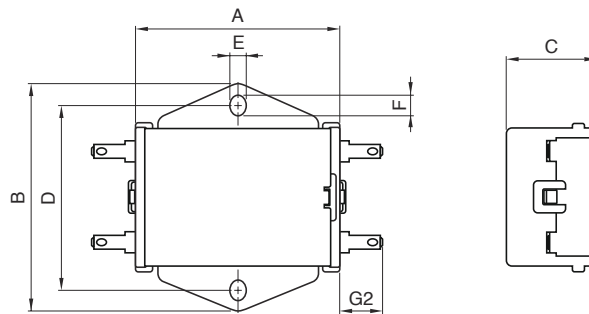

Dimensions in mm

Part No.	A	B	C	D	E	F	G1	G2
RSAL-20R5W(L)	45	50	20	40	3.5	4.5	300	-
RSAL-2001W(L)								
RSAL-2002W(L)								
RSAL-2003W(L)								
RSAL-2006W(L)								
RSAL-20R5A(L)	45	50	20	40	3.5	4.5	-	9
RSAL-2001A(L)								
RSAL-2002A(L)								
RSAL-2003A(L)								
RSAL-2006A(L)								

**ATTENUATION vs. FREQUENCY CHARACTERISTICS**

RSAL-20R5W/A

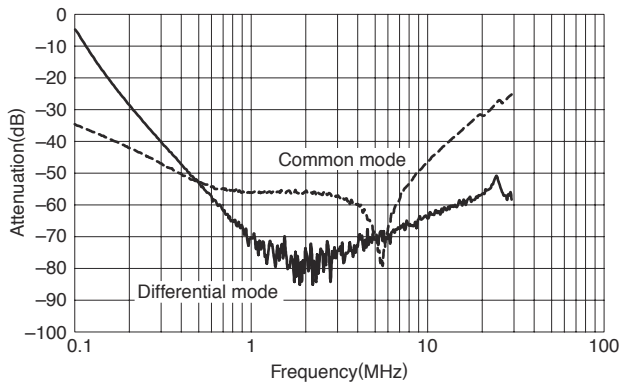

RSAL-2001W/A

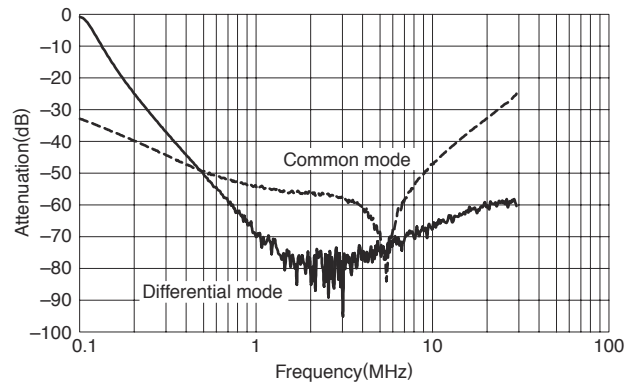

RSAL-2002W/A

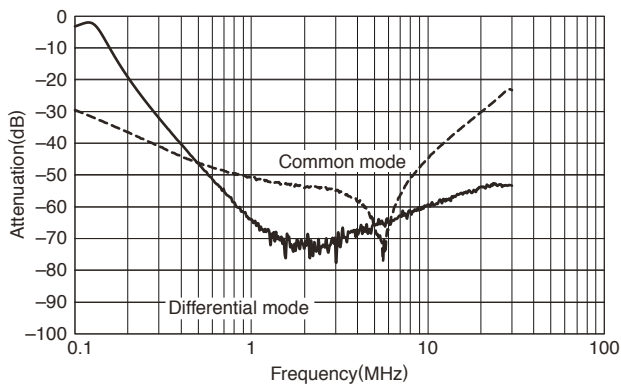

RSAL-2003W/A

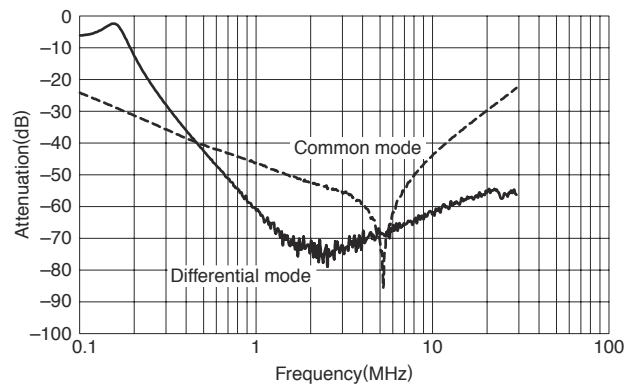

RSAL-2006W/A

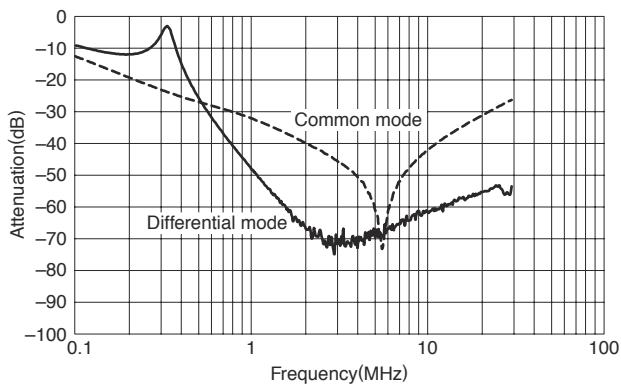

RSAL-20R5WL/AL

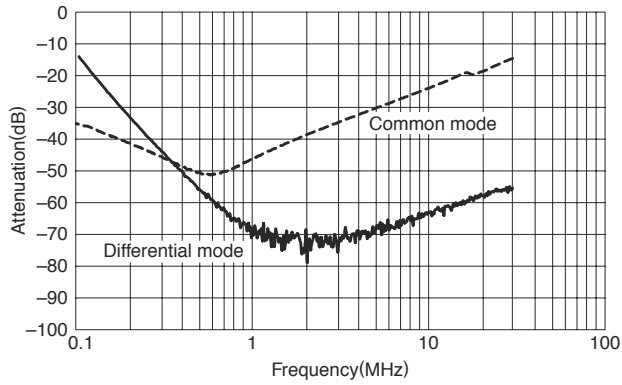

RSAL-2001WL/AL

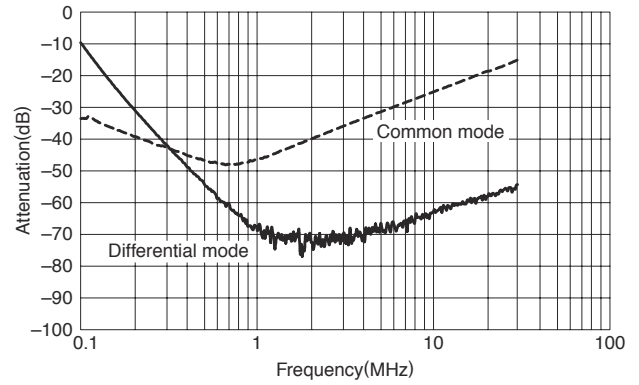

RSAL-2002WL/AL

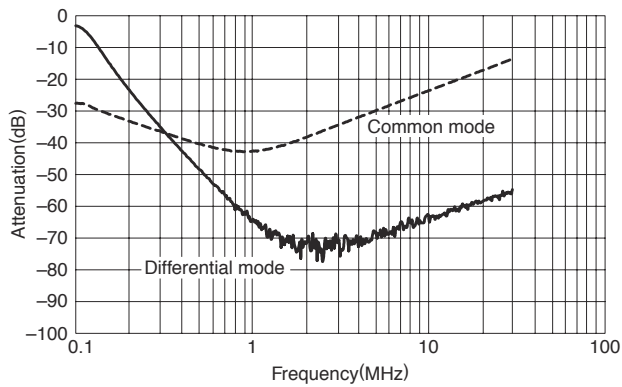

RSAL-2003WL/AL

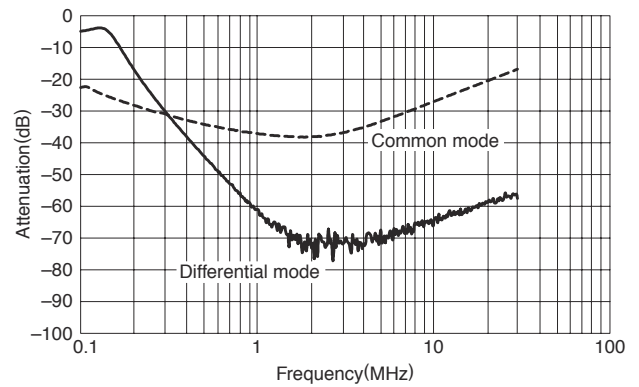

RSAL-2006WL/AL

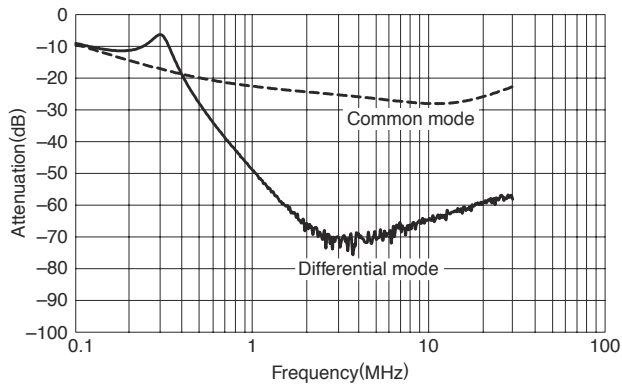

**PULSE ATTENUATION CHARACTERISTICS**

RSAL-20R5W/A

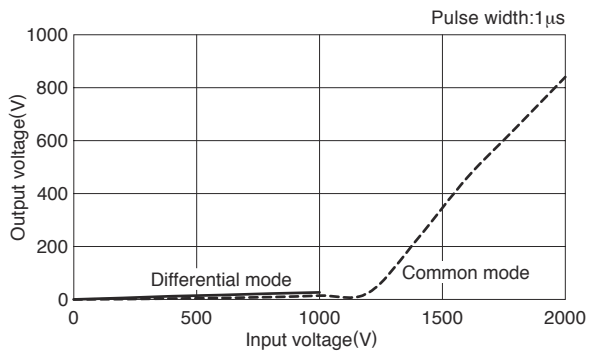

RSAL-2001W/A

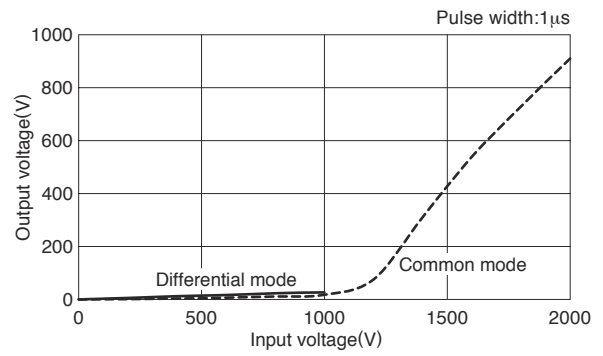

RSAL-2002W/A

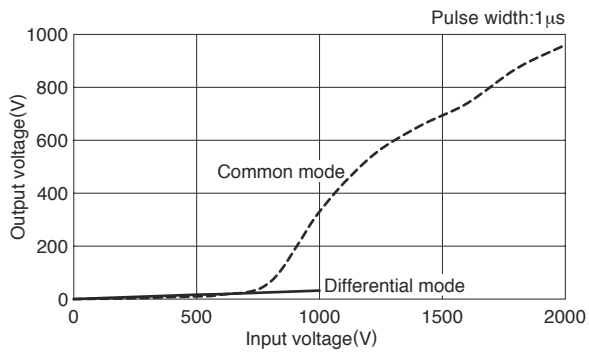

RSAL-2003W/A

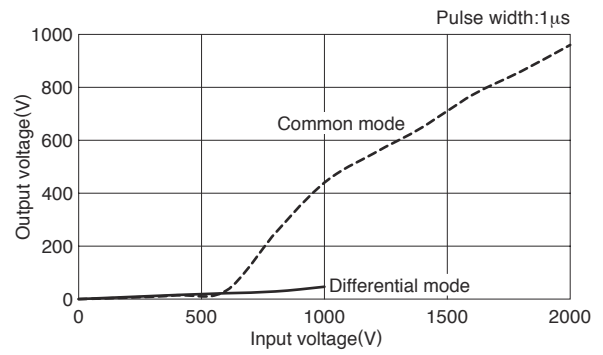

RSAL-2006W/A

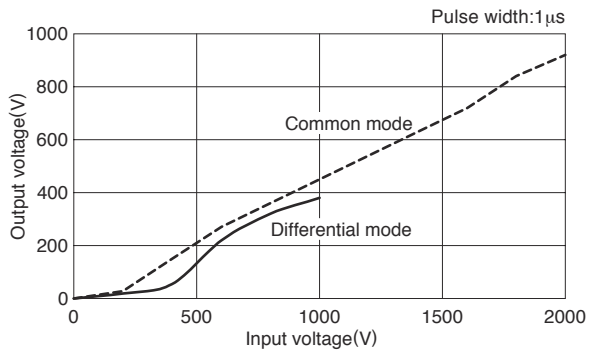

RSAL-20R5WL/AL

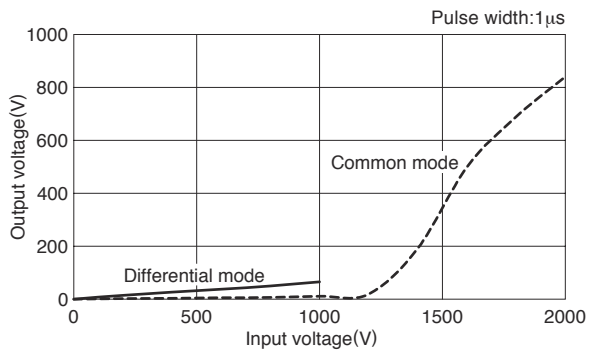

RSAL-2001WL/AL

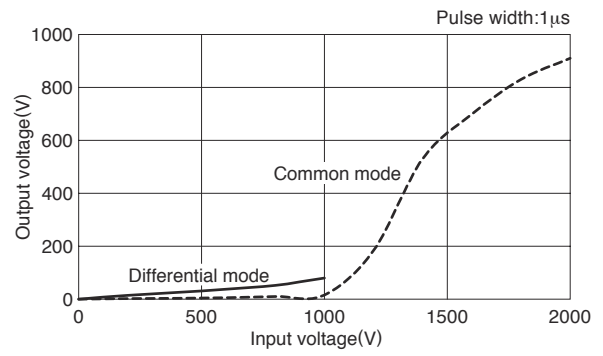

RSAL-2002WL/AL

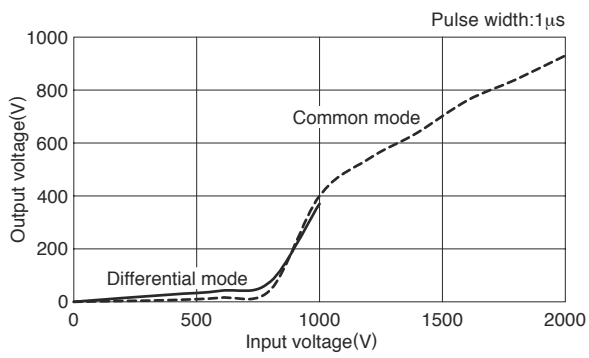

RSAL-2003WL/AL

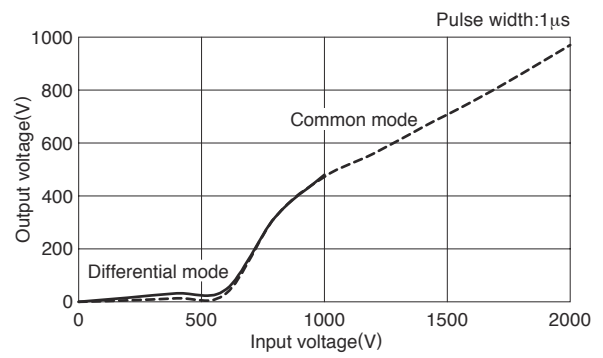

RSAL-2006WL/AL

