



MICROCHIP

**MIC21LV33
Evaluation Board
User's Guide**

Note the following details of the code protection feature on Microchip products:

- Microchip products meet the specifications contained in their particular Microchip Data Sheet.
- Microchip believes that its family of products is secure when used in the intended manner, within operating specifications, and under normal conditions.
- Microchip values and aggressively protects its intellectual property rights. Attempts to breach the code protection features of Microchip product is strictly prohibited and may violate the Digital Millennium Copyright Act.
- Neither Microchip nor any other semiconductor manufacturer can guarantee the security of its code. Code protection does not mean that we are guaranteeing the product is “unbreakable”. Code protection is constantly evolving. Microchip is committed to continuously improving the code protection features of our products.

This publication and the information herein may be used only with Microchip products, including to design, test, and integrate Microchip products with your application. Use of this information in any other manner violates these terms. Information regarding device applications is provided only for your convenience and may be superseded by updates. It is your responsibility to ensure that your application meets with your specifications. Contact your local Microchip sales office for additional support or, obtain additional support at <https://www.microchip.com/en-us/support/design-help/client-support-services>.

THIS INFORMATION IS PROVIDED BY MICROCHIP "AS IS". MICROCHIP MAKES NO REPRESENTATIONS OR WARRANTIES OF ANY KIND WHETHER EXPRESS OR IMPLIED, WRITTEN OR ORAL, STATUTORY OR OTHERWISE, RELATED TO THE INFORMATION INCLUDING BUT NOT LIMITED TO ANY IMPLIED WARRANTIES OF NON-INFRINGEMENT, MERCHANTABILITY, AND FITNESS FOR A PARTICULAR PURPOSE, OR WARRANTIES RELATED TO ITS CONDITION, QUALITY, OR PERFORMANCE.

IN NO EVENT WILL MICROCHIP BE LIABLE FOR ANY INDIRECT, SPECIAL, PUNITIVE, INCIDENTAL, OR CONSEQUENTIAL LOSS, DAMAGE, COST, OR EXPENSE OF ANY KIND WHATSOEVER RELATED TO THE INFORMATION OR ITS USE, HOWEVER CAUSED, EVEN IF MICROCHIP HAS BEEN ADVISED OF THE POSSIBILITY OR THE DAMAGES ARE FORESEEABLE. TO THE FULLEST EXTENT ALLOWED BY LAW, MICROCHIP'S TOTAL LIABILITY ON ALL CLAIMS IN ANY WAY RELATED TO THE INFORMATION OR ITS USE WILL NOT EXCEED THE AMOUNT OF FEES, IF ANY, THAT YOU HAVE PAID DIRECTLY TO MICROCHIP FOR THE INFORMATION.

Use of Microchip devices in life support and/or safety applications is entirely at the buyer's risk, and the buyer agrees to defend, indemnify and hold harmless Microchip from any and all damages, claims, suits, or expenses resulting from such use. No licenses are conveyed, implicitly or otherwise, under any Microchip intellectual property rights unless otherwise stated.

For information regarding Microchip's Quality Management Systems, please visit www.microchip.com/quality.

Trademarks

The Microchip name and logo, the Microchip logo, Adaptec, AnyRate, AVR, AVR logo, AVR Freaks, BesTime, BitCloud, CryptoMemory, CryptoRF, dsPIC, flexPWR, HELDO, IGLOO, JukeBlox, KeeLoq, Kleer, LANCheck, LinkMD, maXStylus, maXTouch, MediaLB, megaAVR, Microsemi, Microsemi logo, MOST, MOST logo, MPLAB, OptoLyzer, PIC, picoPower, PICSTART, PIC32 logo, PolarFire, Prochip Designer, QTouch, SAM-BA, SenGenuity, SpyNIC, SST, SST Logo, SuperFlash, Symmetricom, SyncServer, Tachyon, TimeSource, tinyAVR, UNI/O, Vectron, and XMEGA are registered trademarks of Microchip Technology Incorporated in the U.S.A. and other countries.

AgileSwitch, APT, ClockWorks, The Embedded Control Solutions Company, EtherSynch, Flashtec, Hyper Speed Control, HyperLight Load, IntelliMOS, Libero, motorBench, mTouch, Powermite 3, Precision Edge, ProASIC, ProASIC Plus, ProASIC Plus logo, QuietWire, SmartFusion, SyncWorld, Temux, TimeCesium, TimeHub, TimePictra, TimeProvider, TrueTime, WinPath, and ZL are registered trademarks of Microchip Technology Incorporated in the U.S.A.

Adjacent Key Suppression, AKS, Analog-for-the-Digital Age, Any Capacitor, AnyIn, AnyOut, Augmented Switching, BlueSky, BodyCom, CodeGuard, CryptoAuthentication, CryptoAutomotive, CryptoCompanion, CryptoController, dsPICDEM, dsPICDEM.net, Dynamic Average Matching, DAM, ECAN, Espresso T1S, EtherGREEN, GridTime, IdealBridge, In-Circuit Serial Programming, ICSP, INICnet, Intelligent Paralleling, Inter-Chip Connectivity, JitterBlocker, Knob-on-Display, maxCrypto, maxView, memBrain, Mindi, MiWi, MPASM, MPF, MPLAB Certified logo, MPLIB, MPLINK, MultiTRAK, NetDetach, NVM Express, NVMe, Omniscient Code Generation, PICDEM, PICDEM.net, PICkit, PICTail, PowerSmart, PureSilicon, QMatrix, REAL ICE, Ripple Blocker, RTAX, RTG4, SAM-ICE, Serial Quad I/O, simpleMAP, SimpliPHY, SmartBuffer, SmartHLS, SMART-I.S., storClad, SQL, SuperSwitcher, SuperSwitcher II, Switchtec, SynchroPHY, Total Endurance, TSHARC, USBCheck, VariSense, VectorBlox, VeriPHY, ViewSpan, WiperLock, XpressConnect, and ZENA are trademarks of Microchip Technology Incorporated in the U.S.A. and other countries.

SQTP is a service mark of Microchip Technology Incorporated in the U.S.A.

The Adaptec logo, Frequency on Demand, Silicon Storage Technology, Symmcom, and Trusted Time are registered trademarks of Microchip Technology Inc. in other countries.

GestIC is a registered trademark of Microchip Technology Germany II GmbH & Co. KG, a subsidiary of Microchip Technology Inc., in other countries.

All other trademarks mentioned herein are property of their respective companies.

© 2021, Microchip Technology Incorporated and its subsidiaries.

All Rights Reserved.

ISBN: 978-1-5224-9189-7

Table of Contents

Preface	5
Introduction.....	5
Document Layout	5
Conventions Used in this Guide	6
Recommended Reading.....	6
The Microchip Website	7
Customer Support	7
Document Revision History	7
Chapter 1. Product Overview	
1.1 Introduction	9
1.2 MIC21LV33 Device Overview	9
1.3 MIC21LV33 Device Key Features	9
1.4 MIC21LV33 Evaluation Board Kit Contents	10
Chapter 2. Installation and Operation	
2.1 Introduction	13
2.2 Setup and Configuration	14
Appendix A. Schematic and Layouts	
A.1 Introduction	15
A.2 EV93M52A Board – Schematic	16
A.3 EV93M52A Board – Top Silk	17
A.4 EV93M52A Board – Top Copper and Silk	17
A.5 EV93M52A Board – Top Copper	18
A.6 EV93M52A Board – Inner 1 Copper	18
A.7 EV93M52A Board – Inner 2 Copper	19
A.8 EV93M52A Board – Inner 3 Copper	19
A.9 EV93M52A Board – Inner 4 Copper	20
A.10 EV93M52A Board – Bottom Silk	20
A.11 EV93M52A Board – Bottom Copper and Silk	21
A.12 EV93M52A Board – Bottom Copper	21
Appendix B. Bill of Materials (BOM)	23
Appendix C. Board Waveforms and Performance Curves	
C.1 Main Waveforms	27
C.2 Performance Curves	29
Worldwide Sales and Service	32

MIC21LV33 Evaluation Board User's Guide

NOTES:

Preface

NOTICE TO CUSTOMERS

All documentation becomes dated, and this manual is no exception. Microchip tools and documentation are constantly evolving to meet customer needs, so some actual dialogs and/or tool descriptions may differ from those in this document. Please refer to our website (www.microchip.com) to obtain the latest documentation available.

Documents are identified with a “DS” number. This number is located on the bottom of each page, in front of the page number. The numbering convention for the DS number is “DSXXXXXXXXA”, where “XXXXXXXX” is the document number and “A” is the revision level of the document.

For the most up-to-date information on development tools, see the MPLAB® IDE online help. Select the Help menu, and then Topics to open a list of available online help files.

INTRODUCTION

This chapter contains general information that will be useful to know before using the MIC21LV33 Evaluation Board. Items discussed in this chapter include:

- [Document Layout](#)
- [Conventions Used in this Guide](#)
- [Recommended Reading](#)
- [The Microchip Website](#)
- [Customer Support](#)
- [Document Revision History](#)

DOCUMENT LAYOUT

This document describes how to use the MIC21LV33 Evaluation Board as a development tool. The manual layout is as follows:

- **Chapter 1. “Product Overview”** – Important information about the MIC21LV33 Evaluation Board.
- **Chapter 2. “Installation and Operation”** – Includes instructions on how to get started with the MIC21LV33 Evaluation Board and a description of each function.
- **Appendix A. “Schematic and Layouts”** – Shows the schematic and layout diagrams for the MIC21LV33 Evaluation Board.
- **Appendix B. “Bill of Materials (BOM)”** – Lists the parts used to build the MIC21LV33 Evaluation Board.
- **Appendix C. “Board Waveforms and Performance Curves”** – Includes the board waveforms and performance curves for the MIC21LV33 Evaluation Board.

MIC21LV33 Evaluation Board User's Guide

CONVENTIONS USED IN THIS GUIDE

This manual uses the following documentation conventions:

DOCUMENTATION CONVENTIONS

Description	Represents	Examples
Arial font:		
Italic characters	Referenced books	<i>MPLAB® IDE User's Guide</i>
	Emphasized text	...is the <i>only</i> compiler...
Initial caps	A window	the Output window
	A dialog	the Settings dialog
	A menu selection	select Enable Programmer
Quotes	A field name in a window or dialog	"Save project before build"
Underlined, italic text with right angle bracket	A menu path	<u><i>File>Save</i></u>
Bold characters	A dialog button	Click OK
	A tab	Click the Power tab
N'Rnnnn	A number in verilog format, where N is the total number of digits, R is the radix and n is a digit.	4'b0010, 2'hF1
Text in angle brackets < >	A key on the keyboard	Press <Enter>, <F1>
Courier New font:		
Plain Courier New	Sample source code	#define START
	Filenames	autoexec.bat
	File paths	c:\mcc18\h
	Keywords	_asm, _endasm, static
	Command-line options	-Opa+, -Opa-
	Bit values	0, 1
	Constants	0xFF, 'A'
Italic Courier New	A variable argument	<i>file.o</i> , where <i>file</i> can be any valid filename
Square brackets []	Optional arguments	mcc18 [options] <i>file</i> [options]
Curly brackets and pipe character: { }	Choice of mutually exclusive arguments; an OR selection	errorlevel {0 1}
Ellipses...	Replaces repeated text	var_name [, var_name...]
	Represents code supplied by user	void main (void) { ... }

RECOMMENDED READING

This user's guide describes how to use the MIC21LV33 Evaluation Board, EV93M52A. Another useful document is listed below. The following Microchip document is available and recommended as a supplemental reference resource.

- **MIC21LV33 Data Sheet – “36V Dual Phase, Advanced COT Buck Controller with HyperLight Load® and Phase Shedding” (DS20006512).**

THE MICROCHIP WEBSITE

Microchip provides online support via our website at www.microchip.com. This website is used as a means to make files and information easily available to customers. Accessible by using your favorite Internet browser, the website contains the following information:

- **Product Support** – Data sheets and errata, application notes and sample programs, design resources, user's guides and hardware support documents, latest software releases and archived software
- **General Technical Support** – Frequently Asked Questions (FAQs), technical support requests, online discussion groups, Microchip consultant program member listing
- **Business of Microchip** – Product selector and ordering guides, latest Microchip press releases, listing of seminars and events, listings of Microchip sales offices, distributors and factory representatives

CUSTOMER SUPPORT

Users of Microchip products can receive assistance through several channels:

- Distributor or Representative
- Local Sales Office
- Field Application Engineer (FAE)
- Technical Support

Customers should contact their distributor, representative or field application engineer (FAE) for support. Local sales offices are also available to help customers. A listing of sales offices and locations is included in the back of this document.

Technical support is available through the website at:
<http://www.microchip.com/support>.

DOCUMENT REVISION HISTORY

Revision A (October 2021)

- Initial release of this document.

MIC21LV33 Evaluation Board User's Guide

NOTES:

Chapter 1. Product Overview

1.1 INTRODUCTION

This chapter provides an overview of the MIC21LV33 Evaluation Board and covers the following:

- [MIC21LV33 Device Overview](#)
- [MIC21LV33 Device Key Features](#)
- [MIC21LV33 Evaluation Board Kit Contents](#)

1.2 MIC21LV33 DEVICE OVERVIEW

The MIC21LV33 is constant on-time, dual phase synchronous buck controller featuring a unique adaptive ON-time control architecture with Hyperlight load and phase shedding features enabled. The MIC21LV33 can be used with external MOSFETs and output filter to create Dual phase single output, high current switch mode power supply. MIC21LV33 operates over an input supply range from 4.5V to 36V and can be used to supply up to 50A of output current. The output voltage is adjustable down to 0.6V with a guaranteed accuracy of $\pm 1\%$. The device operates with programmable switching frequency from 100 kHz to 800 kHz per phase. The MIC21LV33 is available in a 32-pin 5 mm x 5 mm QFN with a junction operating range from -40°C to $+125^{\circ}\text{C}$.

1.3 MIC21LV33 DEVICE KEY FEATURES

- Input Voltage Range: 4.5V to 36V
- Adjustable Output From 0.6V To 28V
- Adaptive Constant on Time Control
 - High Delta V Operation
 - Any Capacitor™ Stable
- 0.6V Internal Reference with $\pm 1\%$ Accuracy
- Ripple Injection from Third Node, allowing Greater Than 50% Duty Cycles
- Hyperlight Load and Phase Shedding
- Automatic Phase Shedding of Secondary Phase
- Accurate Current Balancing Between Phases
- Accurate Phasing Between Phases that Are Always 180° Out Of Phase
- 100 kHz To 800 kHz Switching Frequency Per Phase
- High Voltage Internal 5V LDO for Single Supply Operation
- Secondary LDO for Improved System Efficiency
- Supports Start Up To Pre-bias Output
- Remote Sense Amplifier for Tight Output Regulation
- Supports Adaptive Voltage Positioning (AVP) or Droop
- Precision Enable Function For Low Standby Current
- External Programmable Soft Start To Reduce Inrush Current
- Programmable Current Limit And Hiccup Short Circuit Protection
- Thermal Shut Down With Hysteresis

MIC21LV33 Evaluation Board User's Guide

- Die Temperature Sense on MIC21LV33
- Compact size: 5 x 5 mm 32-pin QFN Package
- -40°C to +125°C Junction Temperature Range

1.4 MIC21LV33 EVALUATION BOARD KIT CONTENTS

The MIC21LV33 Evaluation Board kit includes the:

- MIC21LV33 Evaluation Board PCB
- Important Information Sheet
- China RoHS Declaration

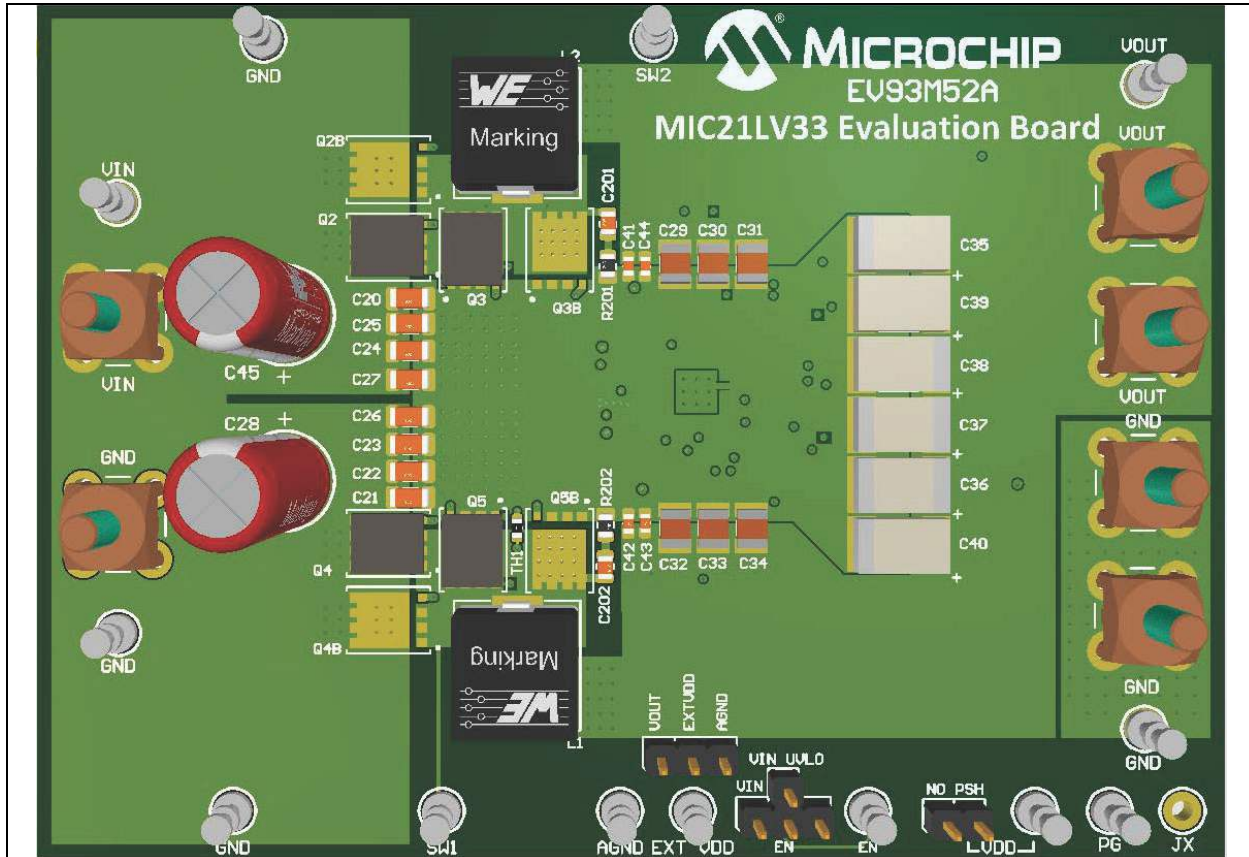

FIGURE 1-1: Typical MIC21LV33 Evaluation Board Evaluation Board, EV93M52A (Top 3D View).

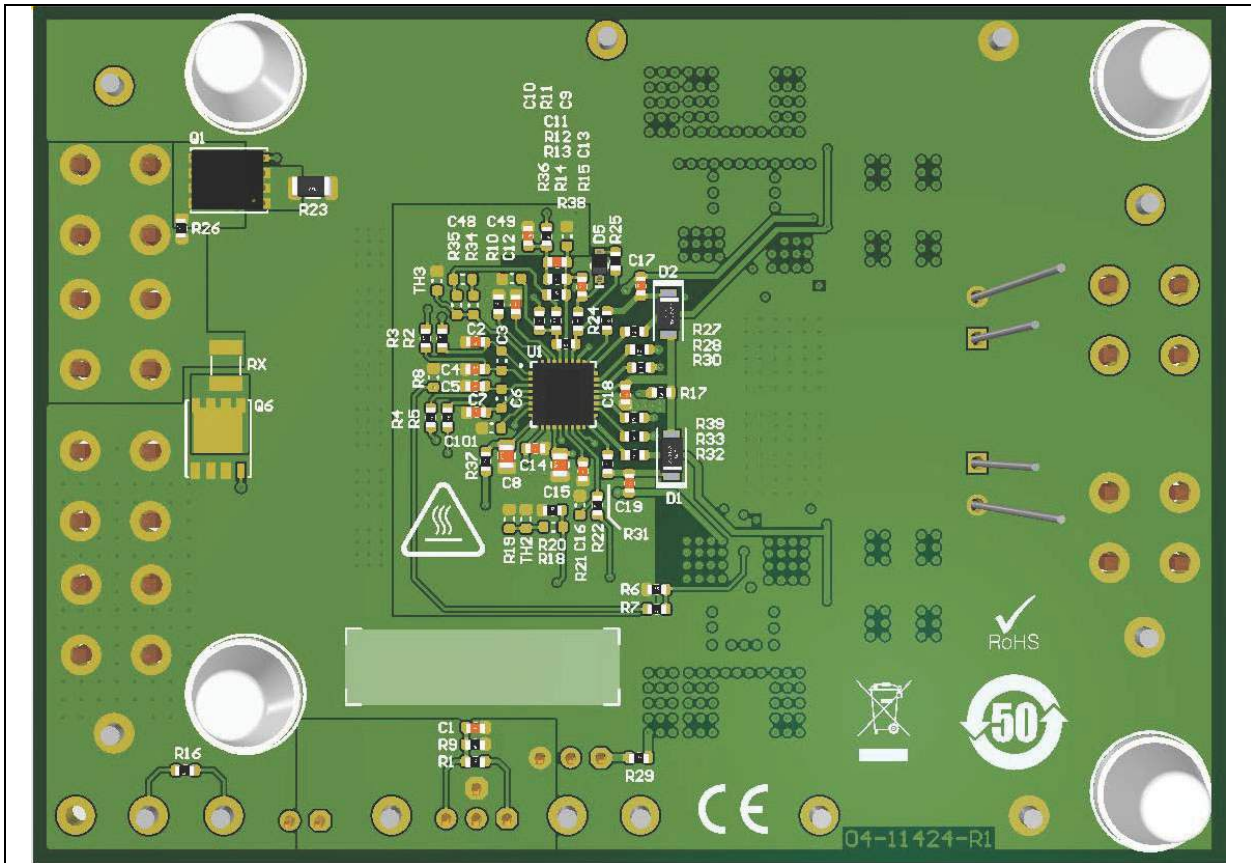

FIGURE 1-2: Typical MIC21LV33 Evaluation Board, EV93M52A (Bottom 3D View).

MIC21LV33 Evaluation Board User's Guide

NOTES:

Chapter 2. Installation and Operation

2.1 INTRODUCTION

The MIC21LV33 Evaluation Board (EV93M52A) is fully assembled and tested to evaluate and demonstrate the MIC21LV33 part capabilities. The board is based on a buck topology and can deliver an adjustable output voltage between 0.6 and 28V, with a maximum current of 50A when supplied with 4.5-36V at the input. However, the board is tuned and optimized for 0.82V/40A output.

2.1.1 Powering the MIC21LV33 Evaluation Board

The board is connected directly to a variable DC power supply that can deliver 4.5 to 36V DC and an output capability of at least 10A. The load could either be a power resistor or an electronic load. In the case of an electronic load, the maximum current that can be drawn is reduced due to the low output voltage.

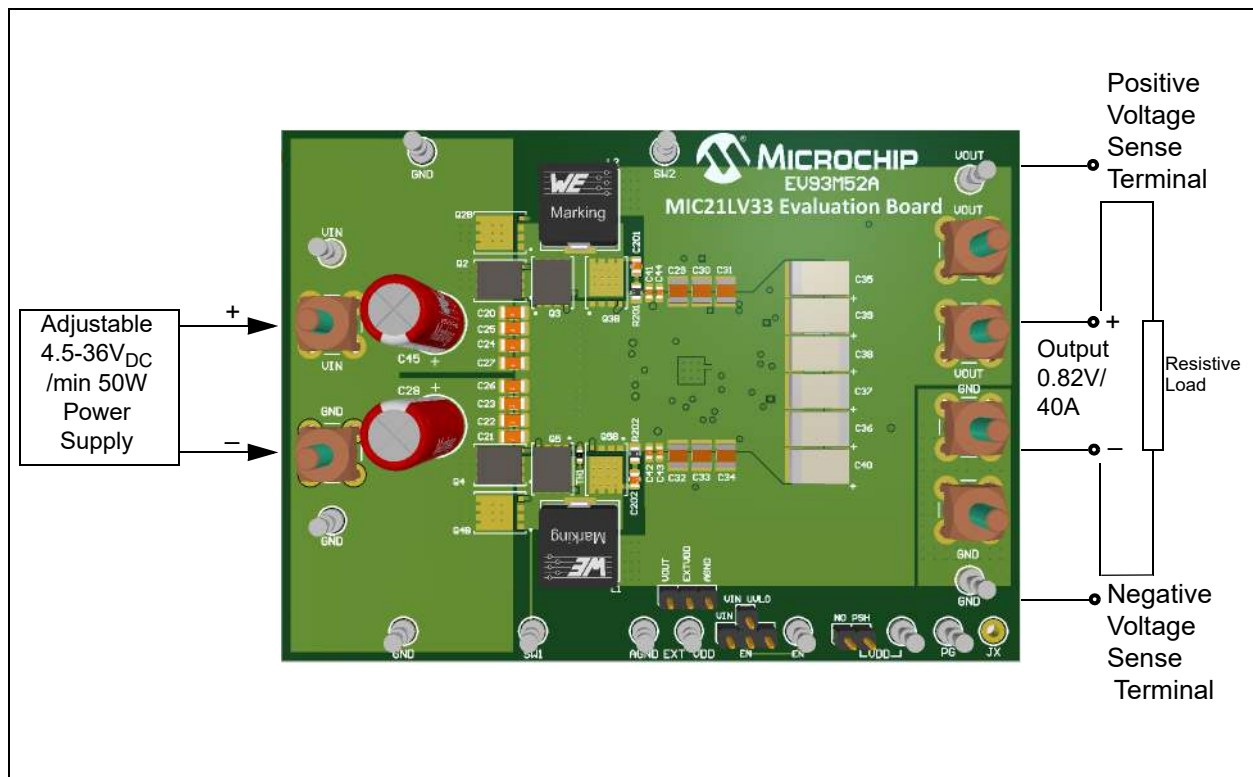

FIGURE 2-1: MIC21LV33 Evaluation Board Connection Diagram.

MIC21LV33 Evaluation Board User's Guide

2.2 SETUP AND CONFIGURATION

The output voltage delivered by the MIC21LV33 Evaluation Board is set to 0.82V. To enable the IC, a jumper on J10 must be placed vertically, between J10-1 and J10-2 as shown in [Figure 2-1](#). MIC21LV33 also features an internal high voltage LDO. To bypass this LDO, a jumper can be plugged on J2-1(VOUT) and J2-2(EXTVDD), but only if the board output voltage is greater than 4.7V. If the internal high voltage LDO is to be used, the jumper should be placed on J2-2 (EXTVDD) and J2-3 (AGND) or left unconnected. EXTVDD can also be connected to an external voltage through the test pin provided.

EXAMPLE 2-1: CALCULATION OF R_{ILIM} FOR BOTTOM MOSFET R_{DSON} CURRENT SENSING

$$I_{LIM} = \frac{0.3V - (0.25 \cdot V_{ILIM})}{R_{dson}} \quad (1)$$
$$V_{ILIM} = 1.2V - (4 \cdot R_{dson} \cdot I_{LIM}) \quad (2)$$

For $I_{LIM} = 20A$ per phase, $R_{dson} = 1 \text{ m}\Omega$ at 25°C , using equation (2)
 $V_{ILIM} = 1.2V - (4 \cdot 1 \text{ m}\Omega \cdot 20A)$.

To obtain 1.12V on the ILIM pin with a 10 μA constant-current source over a constant temperature, a programming equivalent resistor $R_{ILIM} = 1.12V/10\mu\text{A} = 112 \text{ k}\Omega$ is required.

EXAMPLE 2-2: CALCULATION OF THE FEEDBACK DIVIDER FOR 0.82V

$$R_{FB(BOT)} = \frac{R_{FB(TOP)}}{\frac{V_{OUT}}{V_{REF}} - 1} \quad (3)$$

For $V_{OUT} = 0.82V$ having $R_{FB(TOP)} = 20 \text{ k}\Omega$ and $V_{REF} = 0.6V$, using equation (3)
 $R_{FB(BOT)} = 56.6 \text{ k}\Omega$. Due to tolerances, a 56 $\text{k}\Omega$ and 300 Ω resistor in series give a calculated output voltage of 0.82V.

Appendix A. Schematic and Layouts

A.1 INTRODUCTION

This appendix contains the schematics and layouts of the MIC21LV33 Evaluation Board:

- [EV93M52A Board – Schematic](#)
- [EV93M52A Board – Top Silk](#)
- [EV93M52A Board – Top Copper and Silk](#)
- [EV93M52A Board – Top Copper](#)
- [EV93M52A Board – Inner 1 Copper](#)
- [EV93M52A Board – Inner 2 Copper](#)
- [EV93M52A Board – Inner 3 Copper](#)
- [EV93M52A Board – Inner 4 Copper](#)
- [EV93M52A Board – Bottom Silk](#)
- [EV93M52A Board – Bottom Copper and Silk](#)
- [EV93M52A Board – Bottom Copper](#)

A.2 EV93M52A BOARD – SCHEMATIC

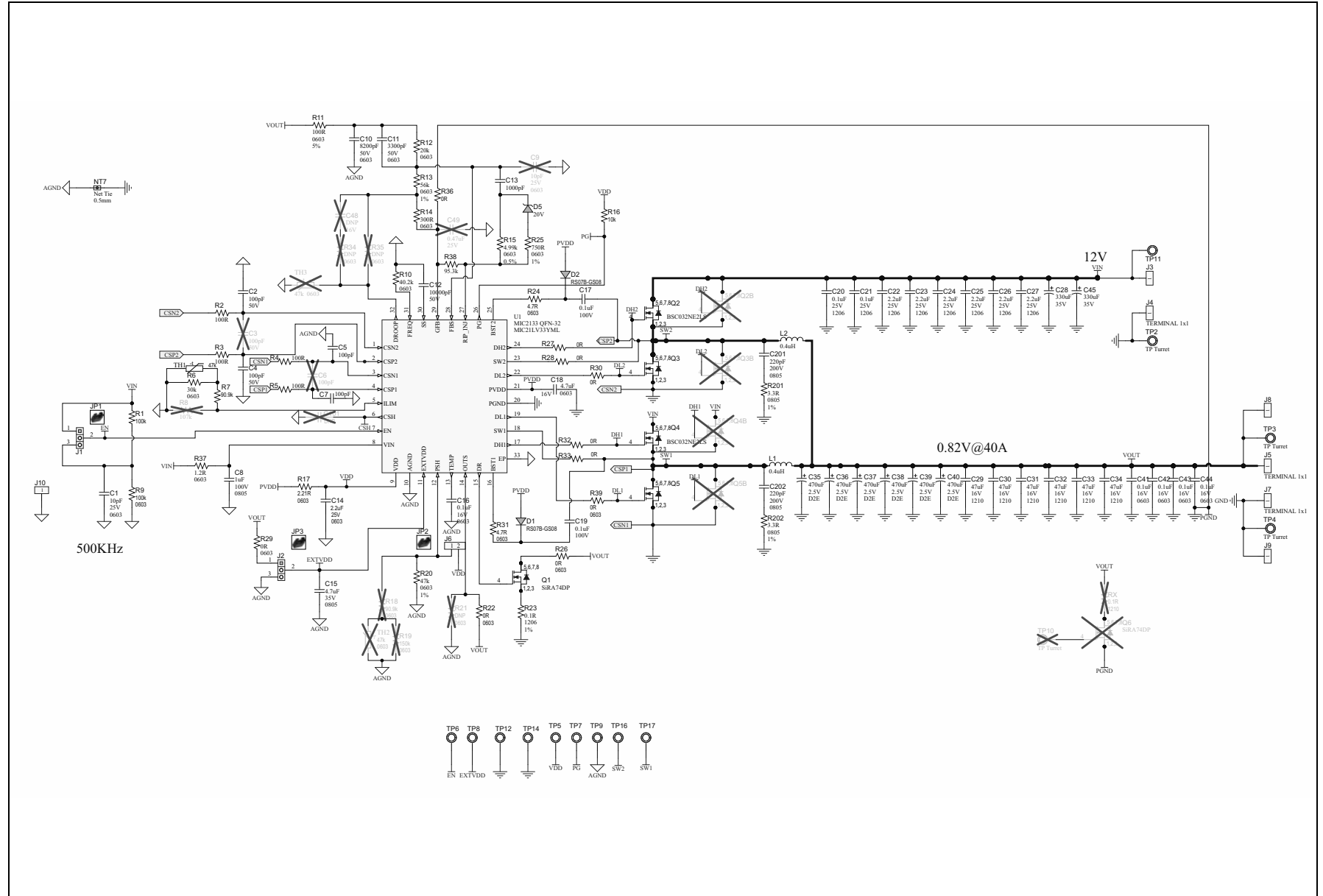

A.3 EV93M52A BOARD – TOP SILK

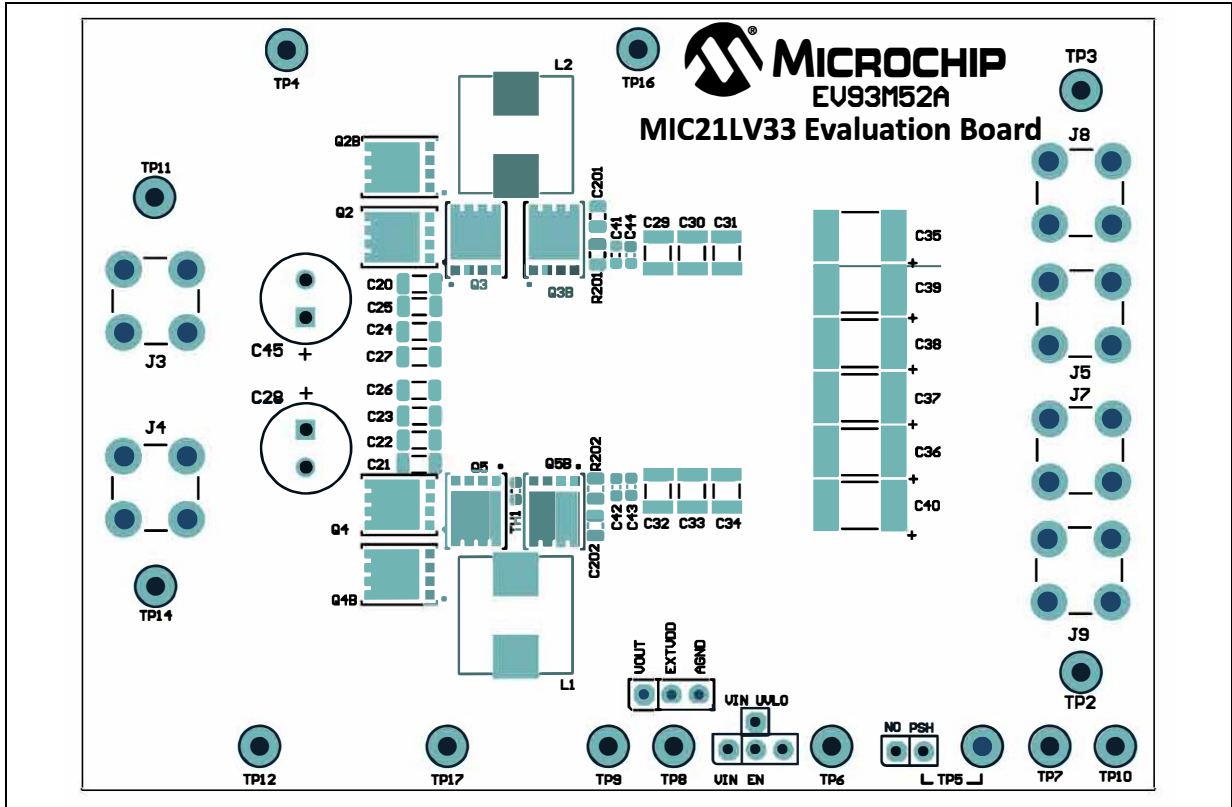

A.4 EV93M52A BOARD – TOP COPPER AND SILK

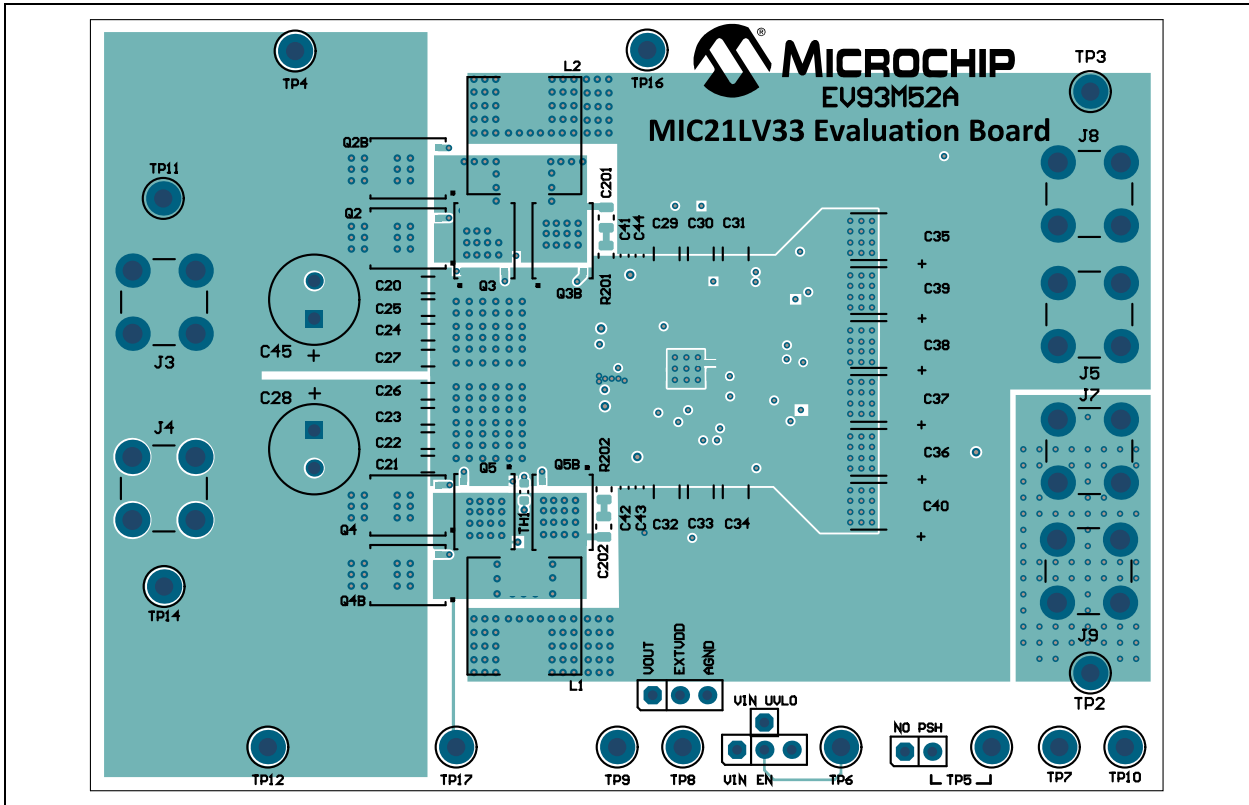

MIC21LV33 Evaluation Board User's Guide

A.5 EV93M52A BOARD – TOP COPPER

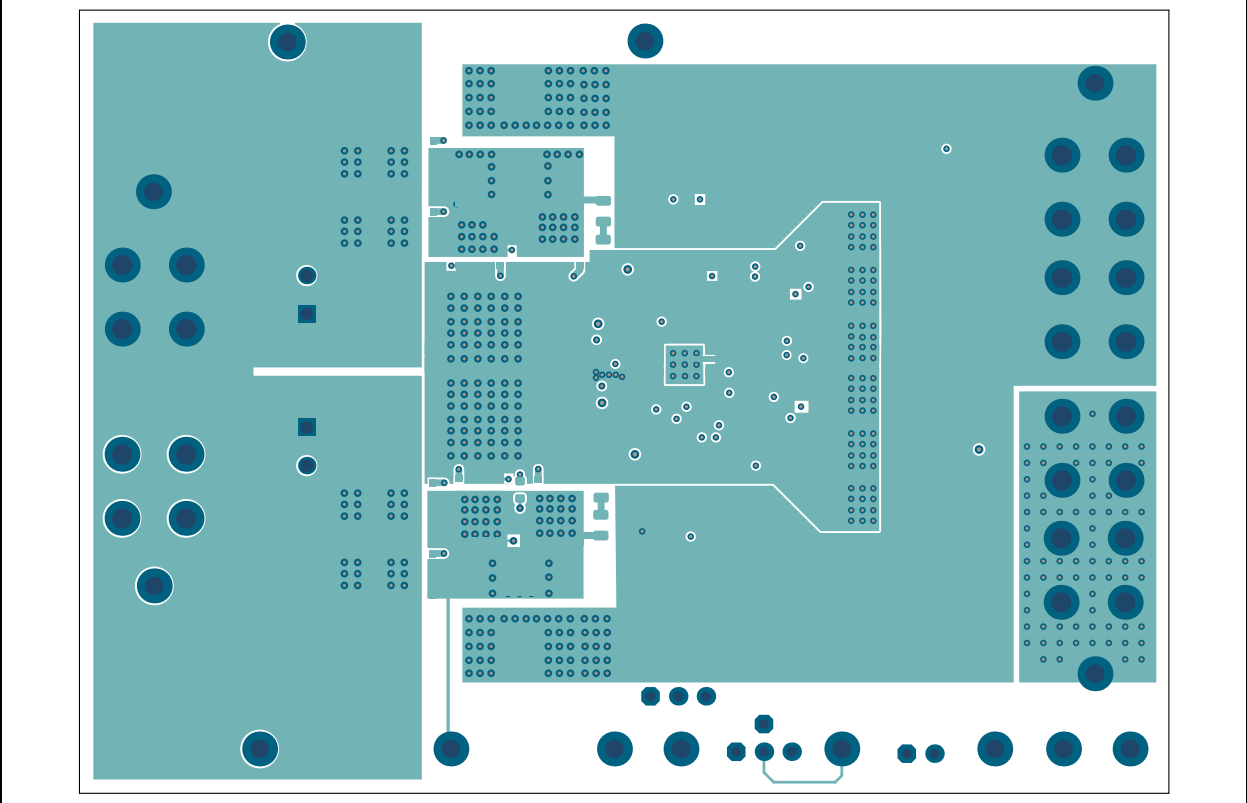

A.6 EV93M52A BOARD – INNER 1 COPPER

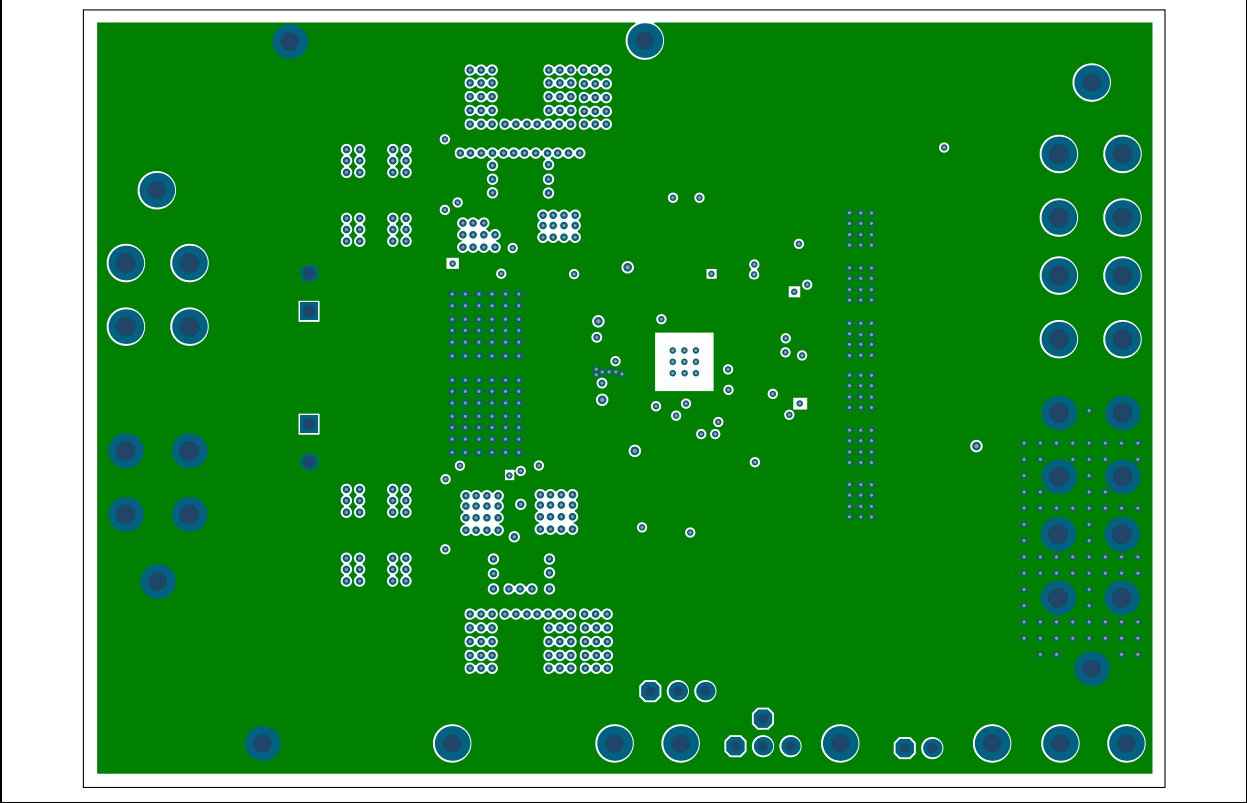

A.7 EV93M52A BOARD – INNER 2 COPPER

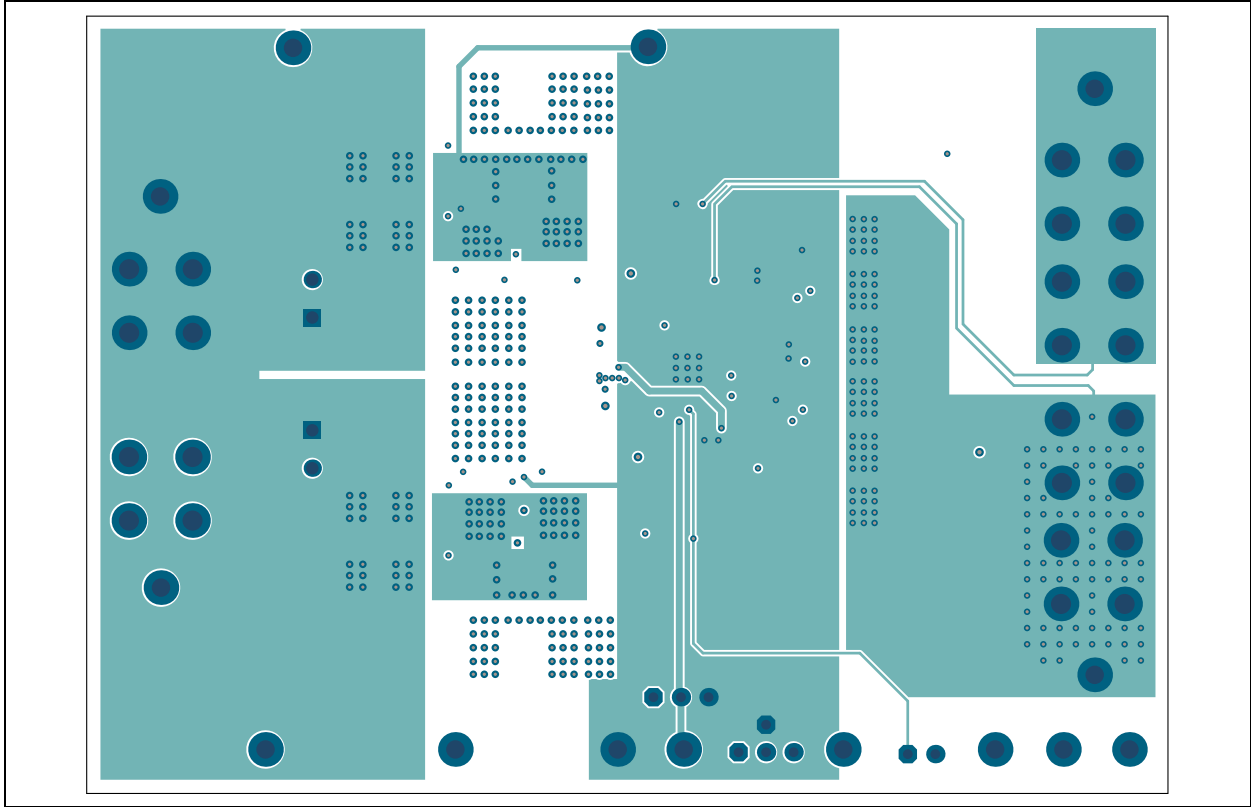

A.8 EV93M52A BOARD – INNER 3 COPPER

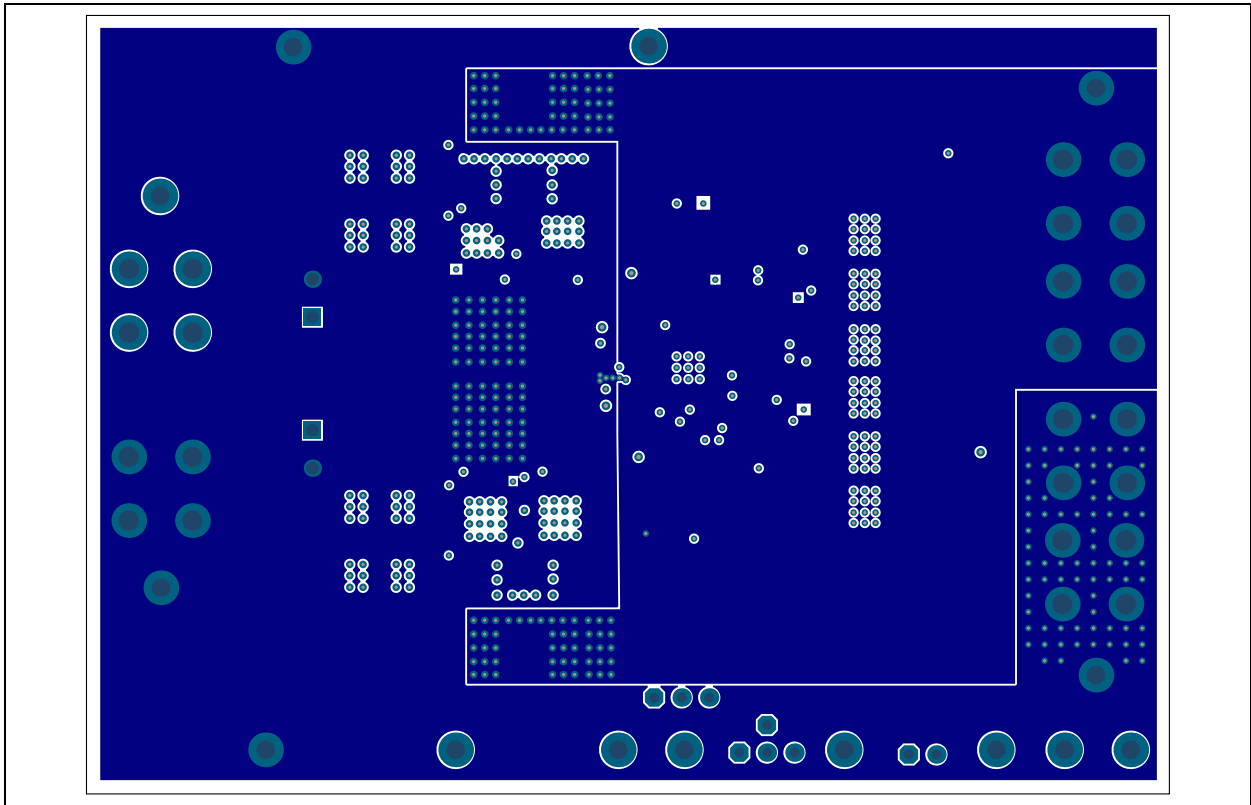

MIC21LV33 Evaluation Board User's Guide

A.9 EV93M52A BOARD – INNER 4 COPPER

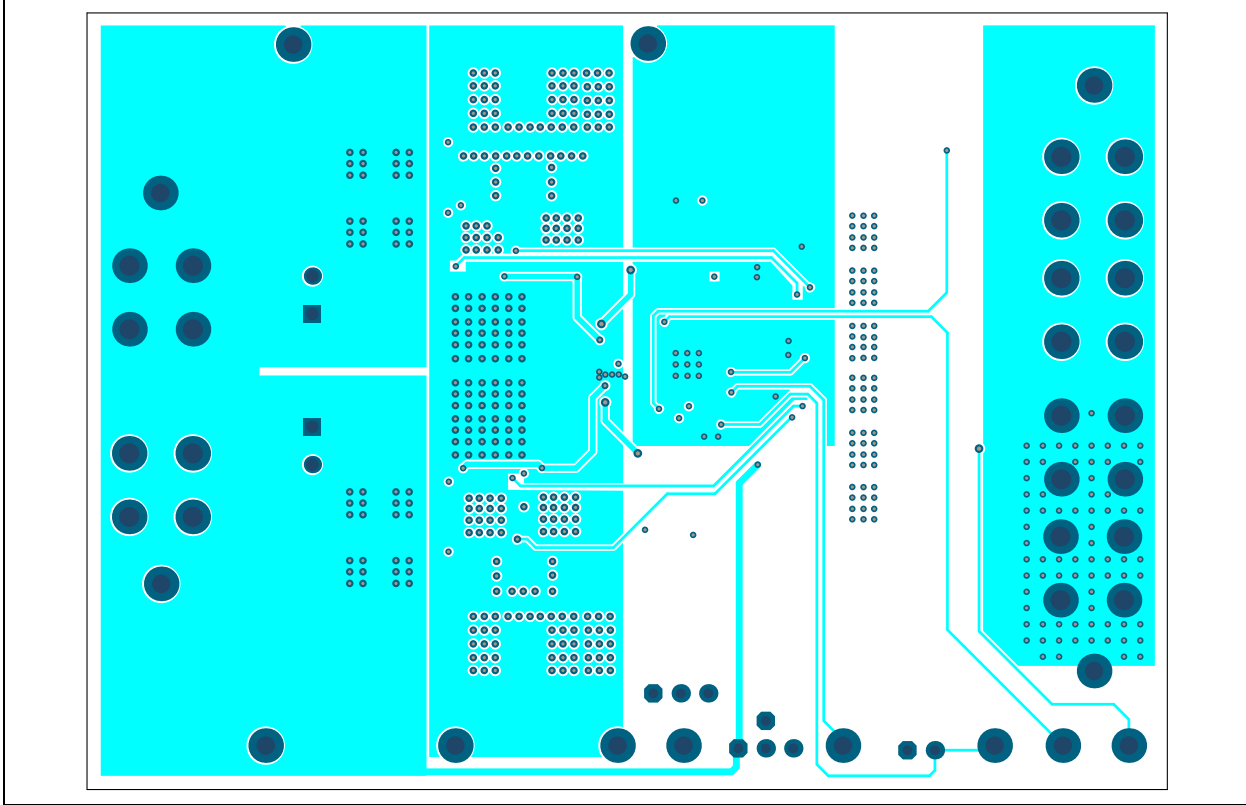

A.10 EV93M52A BOARD – BOTTOM SILK

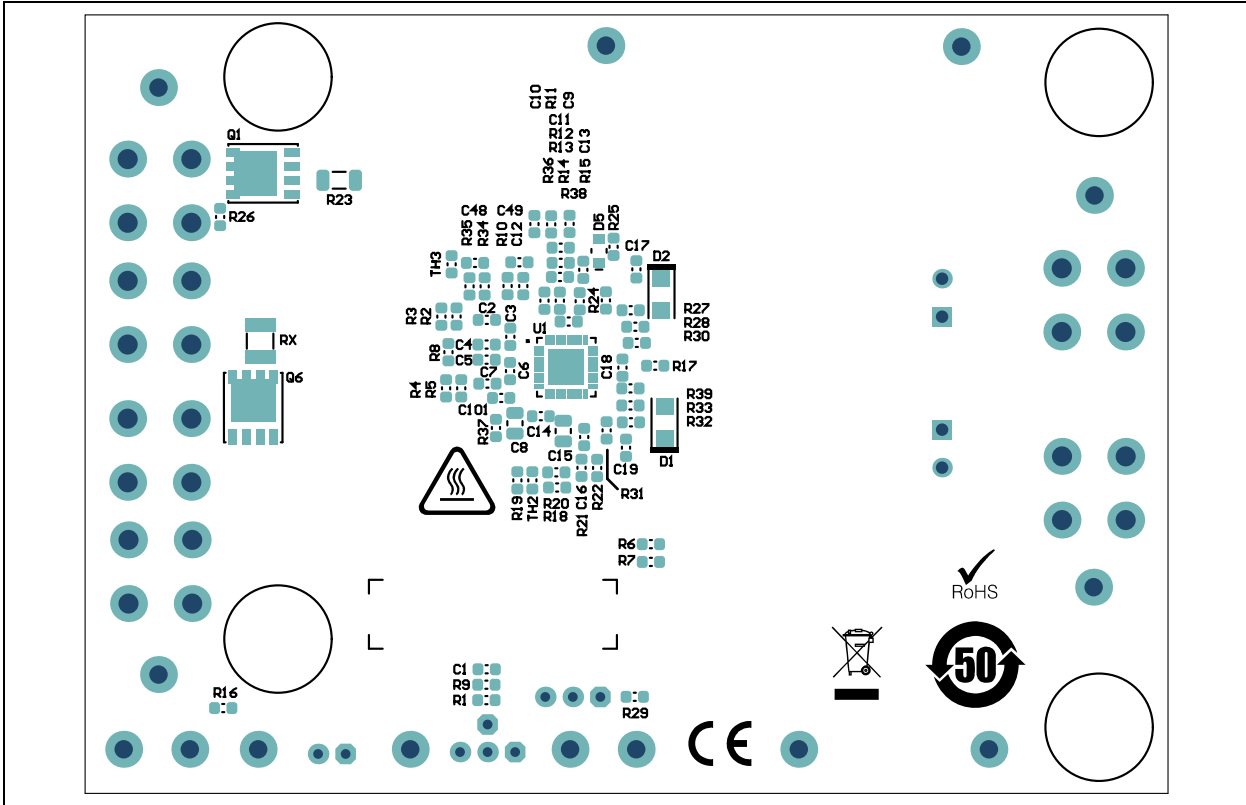

A.11 EV93M52A BOARD – BOTTOM COPPER AND SILK

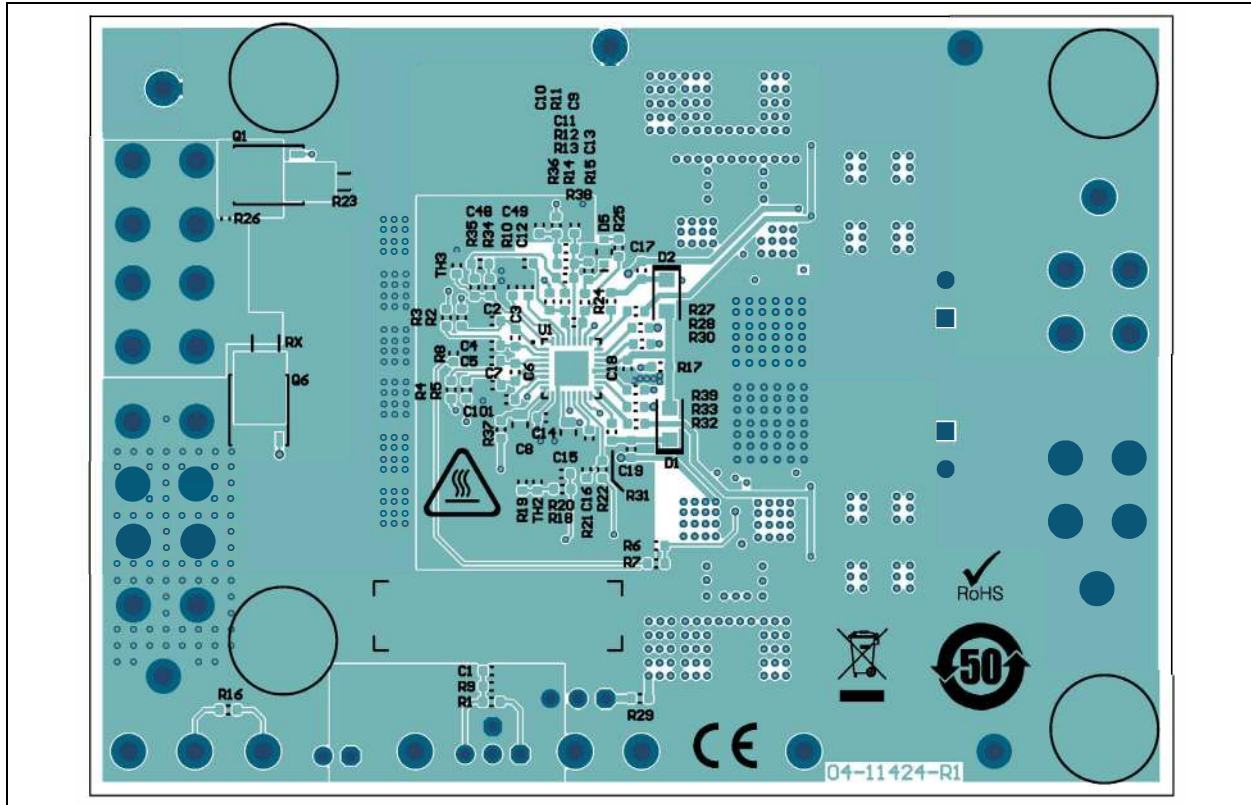

A.12 EV93M52A BOARD – BOTTOM COPPER

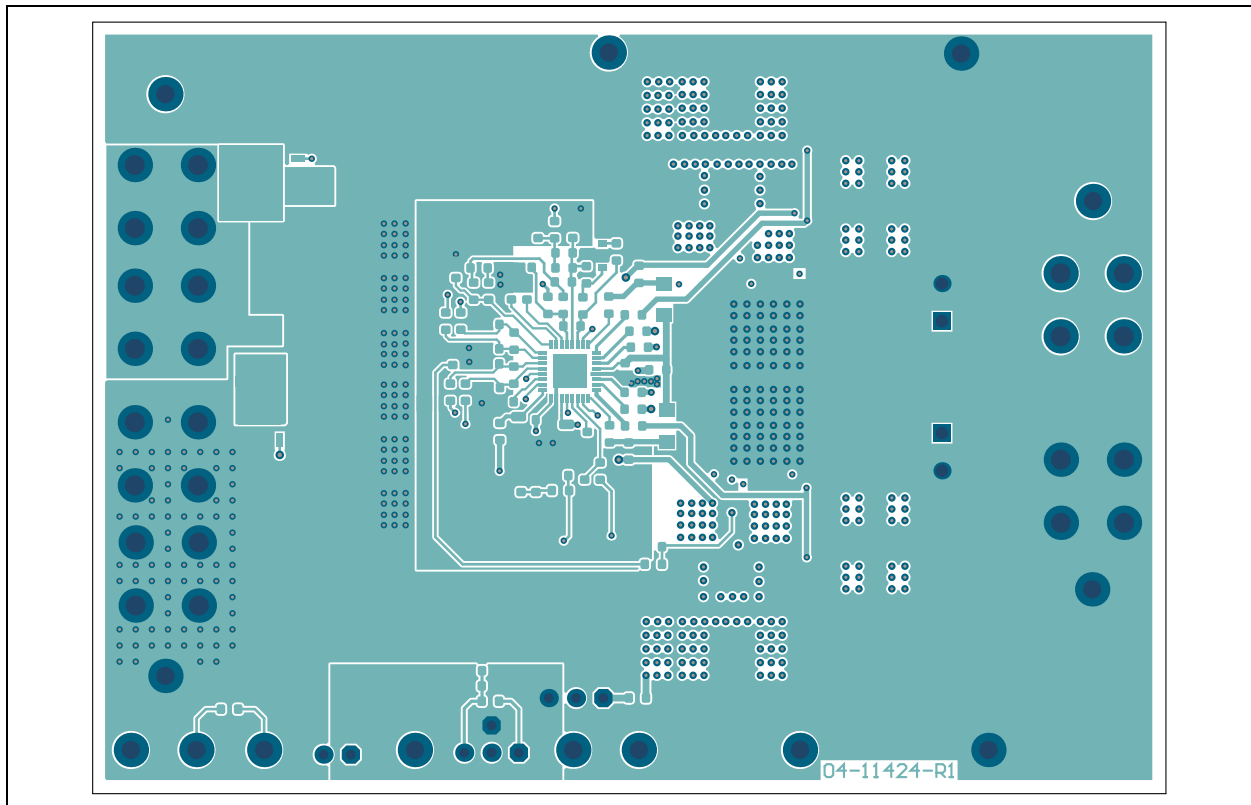

MIC21LV33 Evaluation Board User's Guide

NOTES:

Appendix B. Bill of Materials (BOM)

TABLE B-1: BILL OF MATERIALS (BOM)

Qty.	Reference	Description	Manufacturer	Part Number
1	C1	Capacitor, ceramic, 10pF, 25V, 5%, NP0, surface mount, 0603	Würth Elektronik	885012006032
4	C2, C4, C5, C7	Capacitor, ceramic, 100pF, 50V, 10%, X7R, surface mount, 0603	Würth Elektronik	885012206077
1	C8	Capacitor, ceramic, 1uF, 100V, 10%, X7S, surface mount, 0805	TDK Corporation	C2012X7S2A105K125AB
1	C10	Capacitor, ceramic, 8200pF, 50V, 5%, X7R, surface mount, 0603	Yageo Corporation	CC0603JRX7R9BB822
1	C11	Capacitor, ceramic, 3300pF, 50V, 10%, X7R, surface mount, 0603	Würth Elektronik	885012206086
1	C12	Capacitor, ceramic, 10000pF, 50V, 10%, X7R, surface mount, 0603	Würth Elektronik	885382206002
1	C13	Capacitor, ceramic, 1000pF, 50V, 10%, X7R, surface mount, 0603	Würth Elektronik	885012206083
1	C14	Capacitor, ceramic, 2.2uF, 25V, 10%, X5R, surface mount, 0603	Murata Electronics®	GRM188R61E225KA12D
1	C15	Capacitor, ceramic, 4.7uF, 35V, 10%, X7R, surface mount, 0805	TDK Corporation	C2012X7R1V475K125AE
5	C16, C41, C42, C43, C44	Capacitor, ceramic, 0.1uF, 16V, 10%, X7R, surface mount, 0603	Würth Elektronik	885012206046
2	C17, C19	Capacitor, ceramic, 0.1uF, 100V, 10%, X7R, surface mount, 0603	Würth Elektronik	885012206120
1	C18	Capacitor, ceramic, 4.7uF, 16V, 10%, X5R, surface mount, 0603	TDK Corporation	C1608X5R1C475K080AC
2	C20, C21	Capacitor, ceramic, 0.1uF, 25V, 10%, X7R, surface mount, 1206	Würth Elektronik	885012208058
6	C22, C23, C24, C25, C26, C27	Capacitor, ceramic, 2.2uF, 25V, 10%, X7R, surface mount, 1206	KEMET	C1206C225K3RACTU
	C28, C45	Capacitor, aluminum, 330uF, 35V, 20%, RAD, P3.5D8H20	Würth Elektronik	860080574014
6	C29, C30, C31, C32, C33, C34	Capacitor, ceramic, 47uF, 16V, 20%, X5R, surface mount, 1210	Würth Elektronik	885012109011
6	C35, C36, C37, C38, C39, C40	Capacitor, tantalum, 470uF, 2.5V, 20%, 0.007 Ohm, surface mount, D2E	Panasonic® - ECG	2R5TPE470M7
2	C201, C202	Capacitor, ceramic, 220pF, 200V, 5%, C0G, NP0, surface mount, 0805	Würth Elektronik	885342007001
2	D1, D2	Diode, rectifier, RS07B-GS08, 100V, 500mA, surface mount, DO-219AB	Vishay Semiconductors	RS07B-GS08

Note 1: The components listed in this Bill of Materials are representative of the PCB assembly. The released BOM used in manufacturing uses all RoHS-compliant components.

MIC21LV33 Evaluation Board User's Guide

TABLE B-1: BILL OF MATERIALS (BOM) (CONTINUED)

Qty.	Reference	Description	Manufacturer	Part Number
1	D5	Diode, Zener, MM3Z20VT1G, 20V, 300mW, SOD-323	ON Semiconductor	MM3Z20VT1G
2	J1, J2	Connector, hardware-2.54, male, 1x3, gold, 5.84MH, thru hole, vertical	Amphenol ICC	68000-103HLF
6	J3, J4, J5, J7, J8, J9	Connector, terminal, WE, 74651173R, 50A, male, 1x1, thru hole, vertical	Würth Elektronik	74651173R
1	J6	Connector, hardware-2.54, male, 1x2, gold, 5.84MH, thru hole, vertical	Amphenol ICC (FCI)	77311-118-02LF
1	J10	Connector, hardware-2.54, male, 1x1, gold, 5.84MH, thru hole, vertical	Samtec, Inc.	TSW-101-07-S-S
2	L1, L2	Inductor, 0.4uH, 24A, 20%, surface mount, L10.5W10.2H4.7, AEC-Q200	Würth Elektronik	744325040
1	Q1	Transistor, FET N-Channel, SIRA74DP, 40V, 24A, 46.2W, PPAK SO-8	Vishay Siliconix	SIRA74DP-T1-GE3
2	Q2, Q4	Transistor, FET N-Channel, BSC032NE2LS, 25V, 84A, 37W, TDSON-8	Infineon Technologies AG	BSC032NE2LSATMA1
2	Q3, Q5	Transistor, FET N-Channel, BSC010NE2LSIATMA1, 25V, 38A, 96W, TDSON-8	Infineon Technologies AG	BSC010NE2LSIATMA1
2	R1, R9	Resistor, TF, 100k, 1%, 1/8W, surface mount, 0603	Vishay Beyschlag	MCT06030C1003FP500
4	R2, R3, R4, R5	Resistor, TKF 100R 1% 1/10W surface mount, 0603	Panasonic - ECG	ERJ3EKF1000V
1	R6	Resistor, TKF 30k 5% 1/10W surface mount, 0603	Panasonic - ECG	ERJ3GEYJ303V
1	R7	Resistor, TKF 90.9k 1% 1/10W surface mount, 0603	Panasonic - ECG	ERJ-3EKF9092V
1	R10	Resistor, TKF 40.2k 1% 1/10W surface mount, 0603	Yageo Corporation	RC0603FR-0740K2L
1	R11	Resistor, TKF 100R 5% 1/10W surface mount, 0603	Vishay/Dale	CRCW0603100RJNEA
1	R12	Resistor, TKF 20k 1% 1/10W surface mount, 0603	Panasonic - ECG	ERJ3EKF2002V
1	R13	Resistor, TKF 56k 1% 1/10W surface mount, 0603	Stackpole Electronics Inc.	RMCF0603FT56K0
1	R14	Resistor, TKF 300R 1% 1/10W surface mount, 0603	Yageo Corporation	RC0603FR-07300RL
1	R15	Resistor, TF 4.99k 0.5% 0.15W surface mount, 0603 AEC-Q200	Vishay Beyschlag	MCT0603MD4991DP500
1	R16	Resistor, TF, 10k, 1%, 1/16W, surface mount, 0603	TE Connectivity - Neohm	CPF0603F10KC1
1	R17	Resistor, TF, 2.21R, 0.1%, 1/16W, surface mount, 0603	Stackpole Electronics	RNCF0603BKC2R21

Note 1: The components listed in this Bill of Materials are representative of the PCB assembly. The released BOM used in manufacturing uses all RoHS-compliant components.

Bill of Materials (BOM)

TABLE B-1: BILL OF MATERIALS (BOM) (CONTINUED)

Qty.	Reference	Description	Manufacturer	Part Number
1	R20	Resistor, TKF, 47k, 1%, 1/4W, surface mount, 0603	Vishay	CRCW060347K0FKEAHP
10	R22, R26, R27, R28, R29, R30, R32, R33, R36, R39	Resistor, TKF, 0R, 1/10W, surface mount, surface mount, 0603	Panasonic - ECG	ERJ-3GEY0R00V
1	R23	Resistor, TF, 0.1R, 1%, 1/2W, surface mount, 1206	Susumu Co., LTD.	RL1632R-R100-F
2	R24, R31	Resistor, TKF, 4.7R, 1%, 1/10W, surface mount, 0603	Panasonic - ECG	ERJ-3RQF4R7V
1	R25	Resistor, TKF, 750R, 1%, 1/10W, surface mount, 0603	Vishay	CRCW0603750RFKEA
1	R37	Resistor, TKF, 1.2R, 1%, 1/10W, AEC-Q200, surface mount, 0603	Panasonic - ECG	ERJ-3RQF1R2V
1	R38	Resistor, TKF, 95.3k, 1%, 1/10W, surface mount, 0603	Panasonic - ECG	ERJ-3EKF9532V
2	R201, R202	Resistor, TKF, 3.3R, 1%, 1/8W, surface mount, 0805, AEC-Q200	Stackpole Electronics	RMCF0805FT3R30
1	TH1	Resistor, Thermistor, 47k, 1%, 100mW, surface mount, 0603	Murata Electronics®	NCU18WB473F60RB
13	TP2, TP3, TP4, TP5, TP6, TP7, TP8, TP9, TP11, TP12, TP14, TP16, TP17	Connector, TP Pin, tin, thru-hole	Harwin Plc.	H2121-01

Note 1: The components listed in this Bill of Materials are representative of the PCB assembly. The released BOM used in manufacturing uses all RoHS-compliant components.

TABLE B-2: BILL OF MATERIALS (BOM) – MICROCHIP PARTS

Qty.	Reference	Description	Manufacturer	Part Number
1	U1	Microchip, Analog, 36V, Dual Phase COT Switching Buck Controller, MIC21LV33YML-TR QFN-32	Microchip Technology Inc.	MIC21LV33YML-TR

Note 1: The components listed in this Bill of Materials are representative of the PCB assembly. The released BOM used in manufacturing uses all RoHS-compliant components.

TABLE B-3: BILL OF MATERIALS (BOM) – MECHANICAL PARTS

Qty.	Reference	Description	Manufacturer	Part Number
3	JP1, JP2, JP3	Mechanical, hardware, jumper, 2.54mm, 1x2	3M	969102-0000-DA
1	LABEL	1 label, assembly w/revision level (small modules), per MTS-0002	–	–
4	PAD1, PAD2, PAD3, PAD4	Mechanical, hardware, rubber pad, cylindrical, 0.374" x 0.189", clear	Essentra Plc.	RBS-35
1	PCB1	Printed Circuit Board	–	04-11424-R1

Note 1: The components listed in this Bill of Materials are representative of the PCB assembly. The released BOM used in manufacturing uses all RoHS-compliant components.

MIC21LV33 Evaluation Board User's Guide

TABLE B-4: BILL OF MATERIALS (BOM) – DO NOT POPULATE PARTS

Qty.	Reference	Description	Manufacturer	Part Number
0	C3, C6	Capacitor, ceramic, 100pF, 50V, 10%, X7R, surface mount, 0603	Wurth Elektronik	885012206077
0	C9	Capacitor, ceramic, 10pF, 25V, 5%, NP0, surface mount, 0603	Wurth Elektronik	885012006032
0	C48	Capacitor, ceramic, 1uF, 16V, 10%, X5R, surface mount, 0603	Kyocera AVX	0603YD105KAT2A/4K
0	C49	Capacitor, ceramic, 0.47uF, 25V, 10%, X7R, surface mount, 0603	Murata Electronics®	GRM188R71E474KA12D
0	C101	Capacitor, ceramic, 0.1uF, 16V, 10%, X7R, surface mount, 0603	Taiyo Yuden	CEEMK107B7104KA-T
0	Q2B, Q4B	Transistor, FET, N-Channel, BSC032NE2LS, 25V, 84A, 37W, TDSON-8	Infineon	BSC032NE2LSATMA1
0	Q3B, Q5B	Transistor, FET, N-Channel, BSC010NE2LSIATMA1, 25V, 38A, 96W, TDSON-8	Infineon	BSC010NE2LSIATMA1
0	Q6	Transistor, FET, N-Channel, SIRA74DP, 40V, 24A, 46.2W, PPAK, SO-8	Vishay Siliconix	SIRA74DP-T1-GE3
0	R8	Resistor, TKF, 107k, 1%, 1/10W, surface mount, 0603	Panasonic - ECG	ERJ-3EKF1073V
0	R18	Resistor, TKF, 90.9k, 1%, 1/10W, surface mount, 0603	Panasonic - ECG	ERJ-3EKF9092V
0	R19	Resistor, TKF, 150k, 1%, 1/8W, surface mount, 0603	KOA Speer	SG73S1JTDD1503F
0	R21	Resistor, TKF, 0R, 1/10W, surface mount, 0603	Panasonic - ECG	ERJ-3GEY0R00V
0	R34, R35	Resistor, TKF, 39k, 1%, 1/10W, surface mount, 0603	Panasonic - ECG	ERJ-3EKF3902V
0	RX	Resistor, TKF, 0.1R, 1%, 1/3W, surface mount, 1210	Panasonic - ECG	ERJ-L14KF10CU
0	TH2, TH3	Resistor, Thermistor, 47k, 1%, 100mW, surface mount, 0603	Murata Electronics®	NCU18WB473F60RB
0	TP10	Connector, TP, Pin, Tin, thru-hole	Harwin	H2121-01
0	Q6	Transistor, FET, N-Channel, SIRA74DP, 40V, 24A, 46.2W, PPAK, SO-8	Vishay Siliconix	SIRA74DP-T1-GE3
0	R8	Resistor, TKF, 107k, 1%, 1/10W, surface mount, 0603	Panasonic - ECG	ERJ-3EKF1073V

Note 1: The components listed in this Bill of Materials are representative of the PCB assembly. The released BOM used in manufacturing uses all RoHS-compliant components.

Appendix C. Board Waveforms and Performance Curves

C.1 MAIN WAVEFORMS

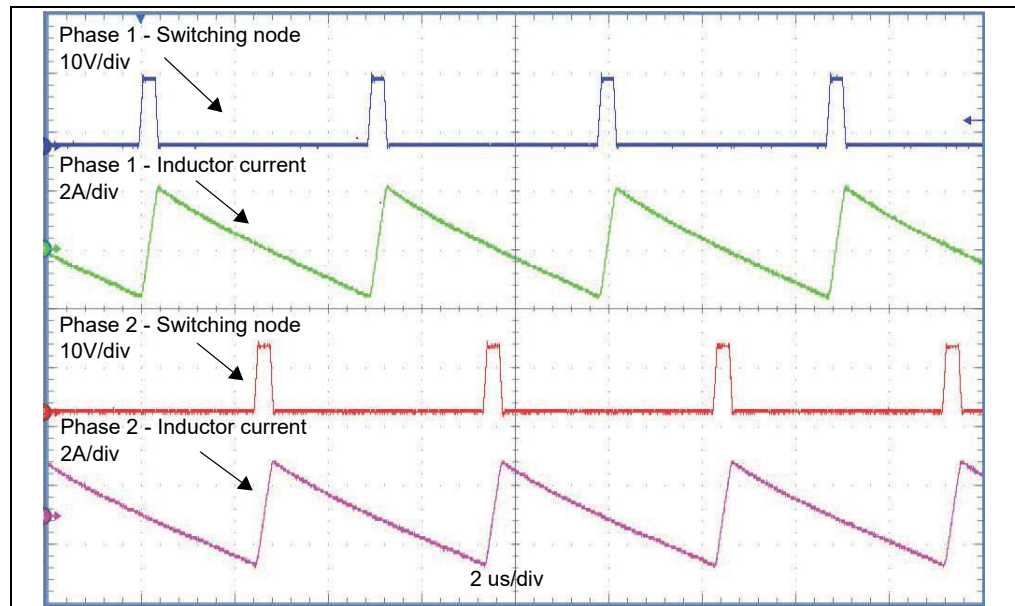

FIGURE C-1: Switching Node Waveforms for V_{in} 12V, V_{out} 0.82V and No Load.

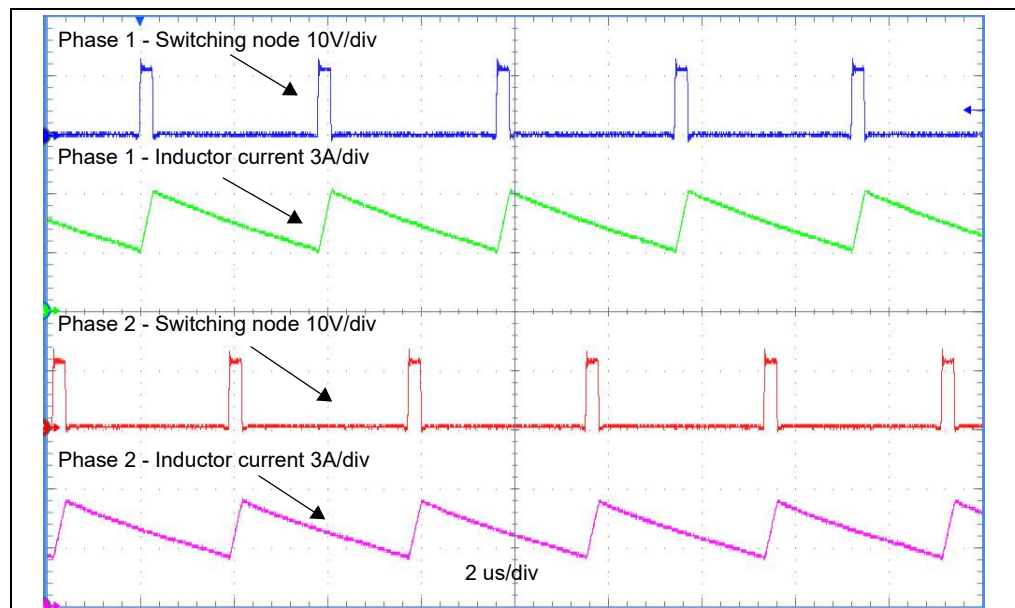

FIGURE C-2: Switching Node Waveforms for $V_{in} = 12V$, $V_{out} = 0.82V$ and $I_{out} = 8A$.

MIC21LV33 Evaluation Board User's Guide

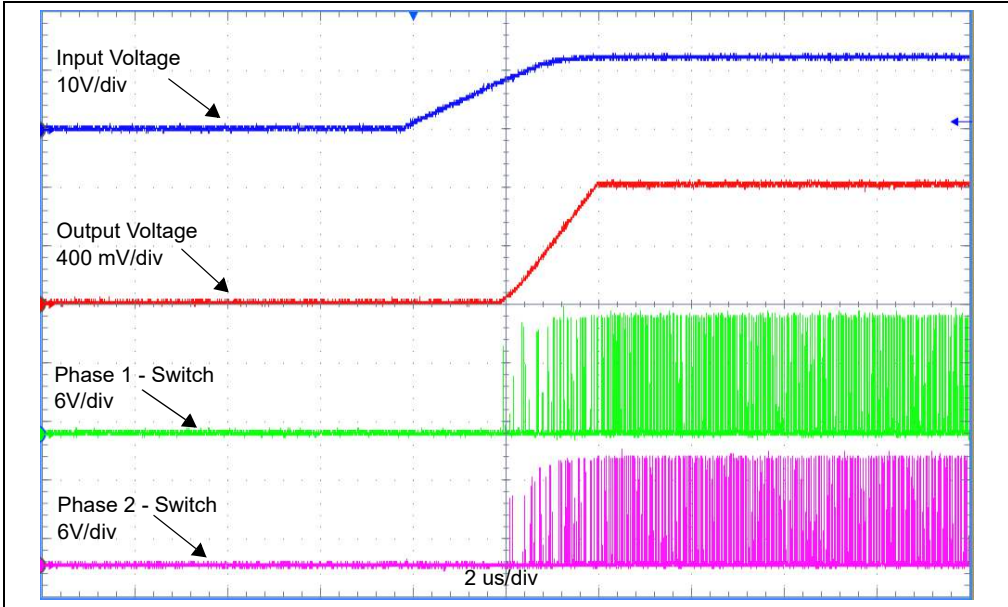

FIGURE C-3: Soft Start.

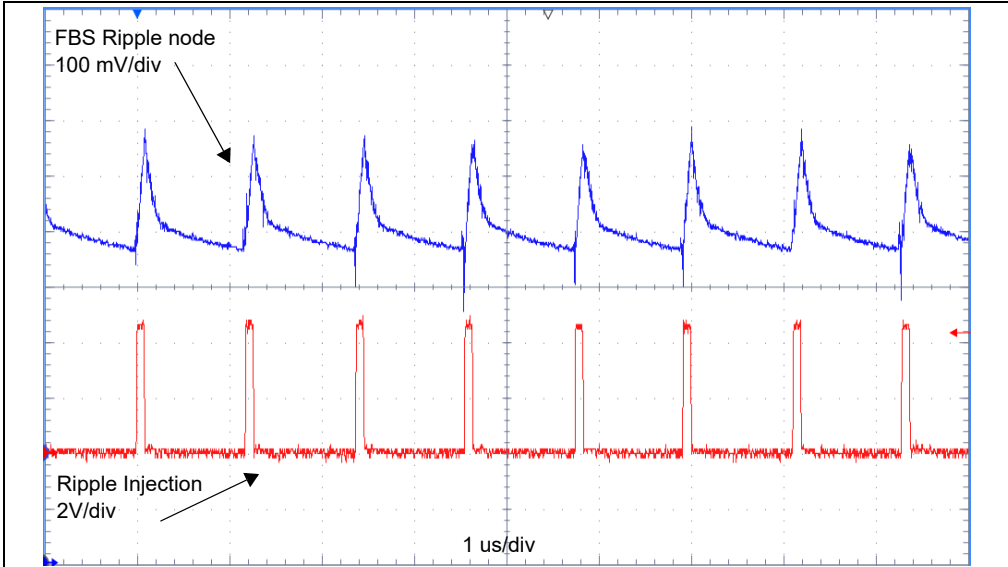

FIGURE C-4: Ripple Injection 12V In, 0.82V Out, 0A.

Board Waveforms and Performance Curves

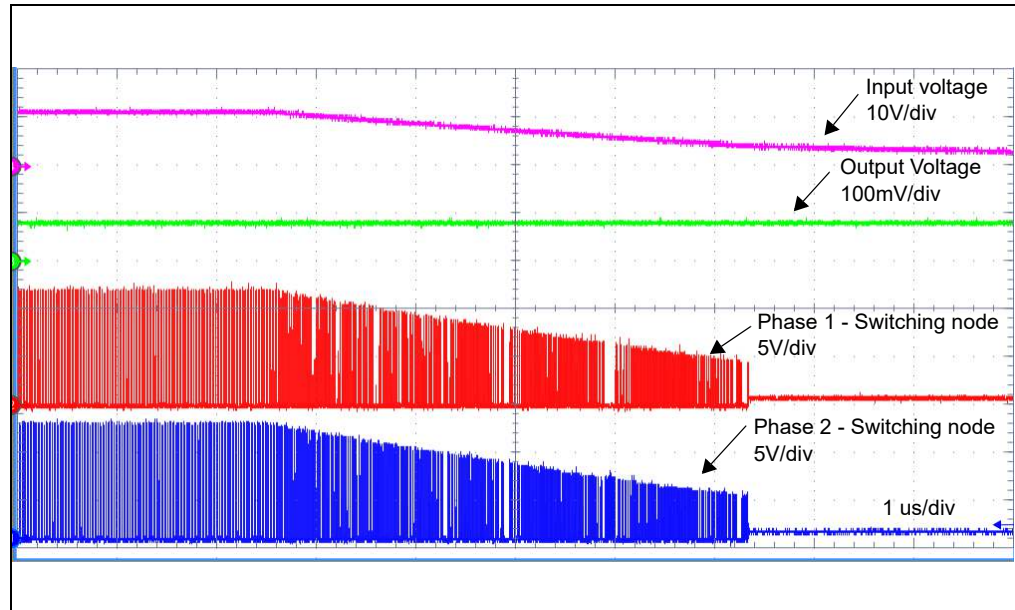

FIGURE C-5: Power Down.

C.2 PERFORMANCE CURVES

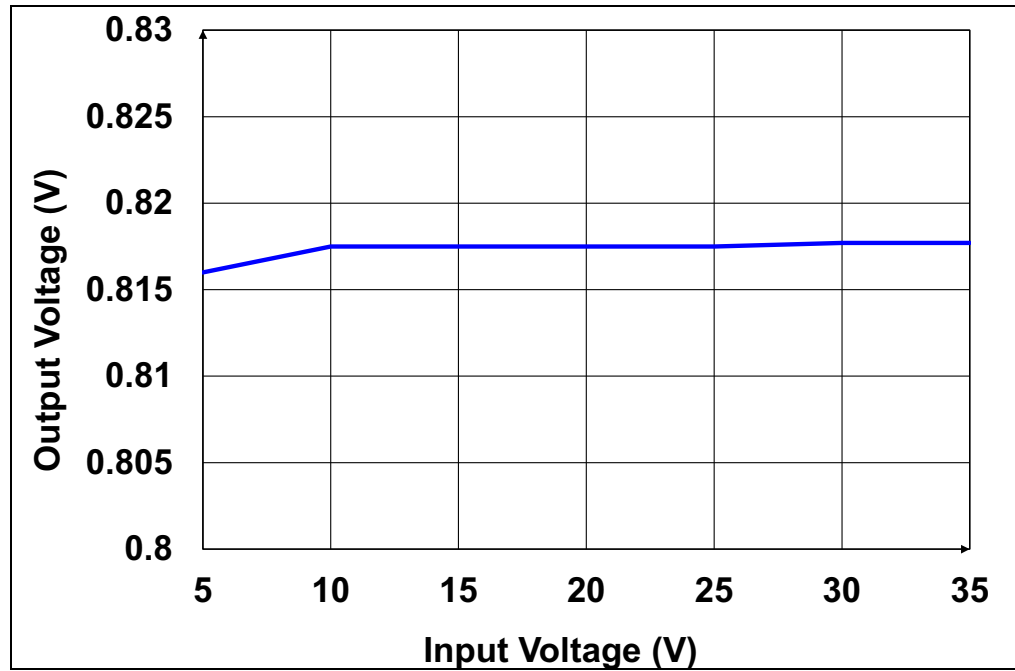

FIGURE C-6: Output Voltage vs Input Voltage with No Load.

MIC21LV33 Evaluation Board User's Guide

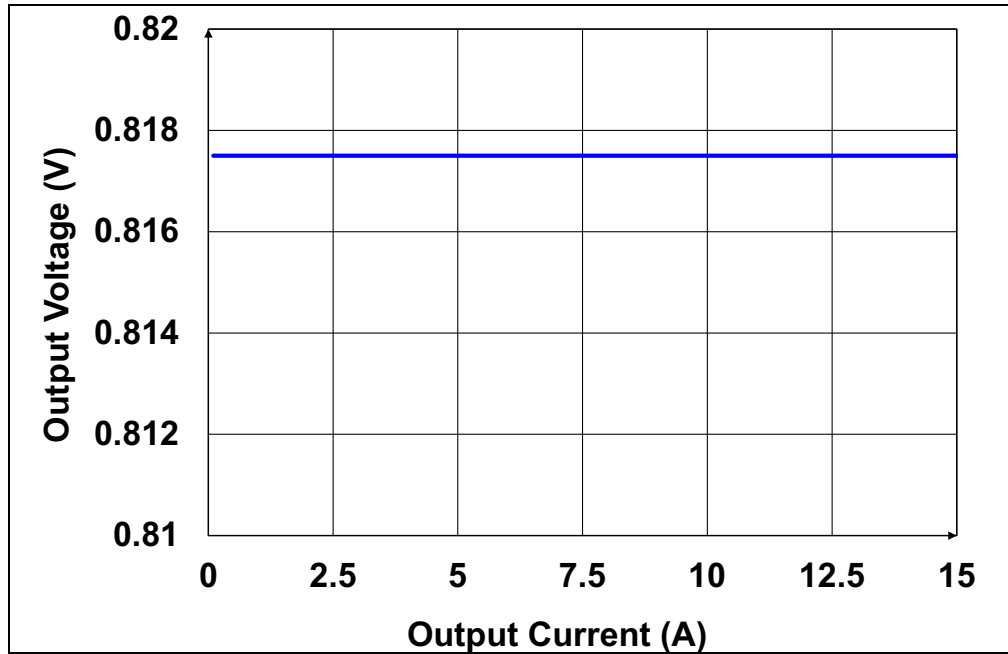

FIGURE C-7: Output Voltage vs Output Current ($V_{in} = 12V$).

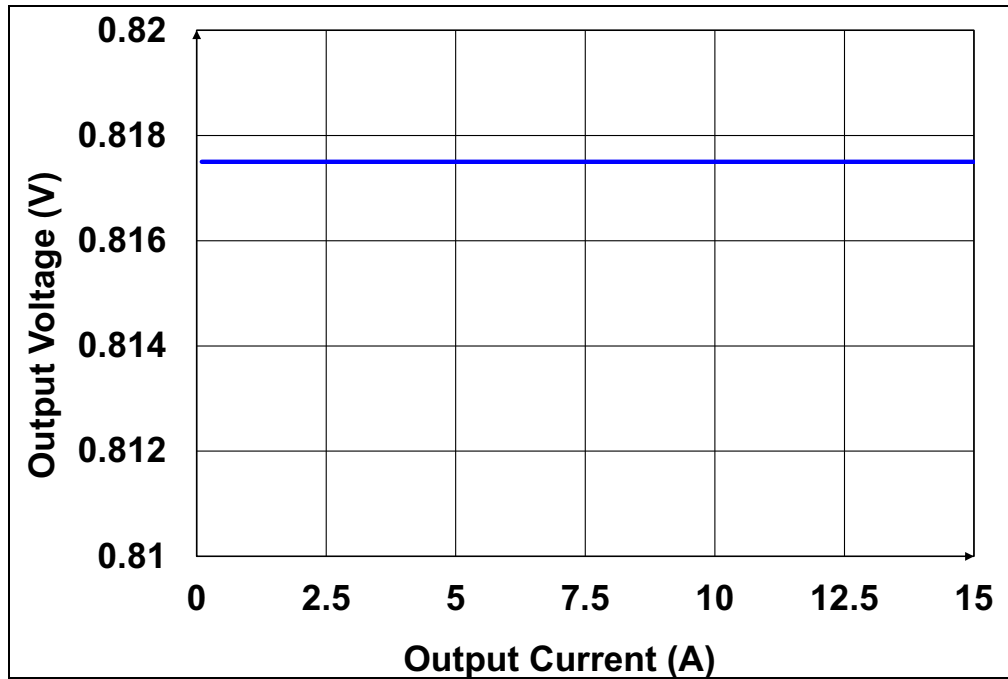

FIGURE C-8: Output Voltage vs Output Current ($V_{in} = 20V$).

Board Waveforms and Performance Curves

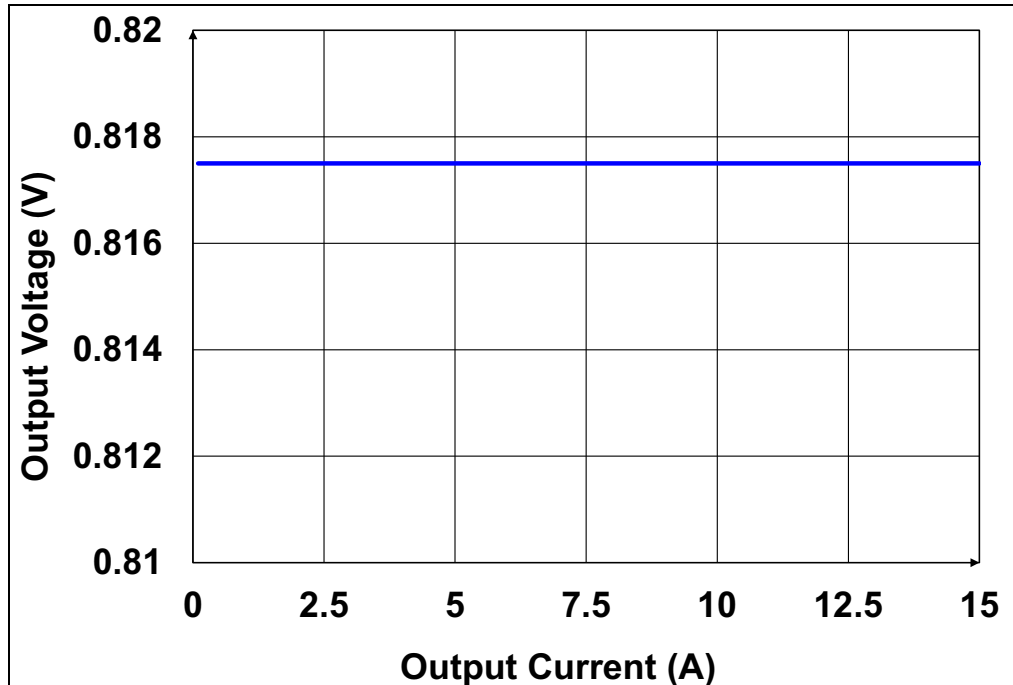

FIGURE C-9: Output Voltage vs Output Current ($V_{in} = 35V$).

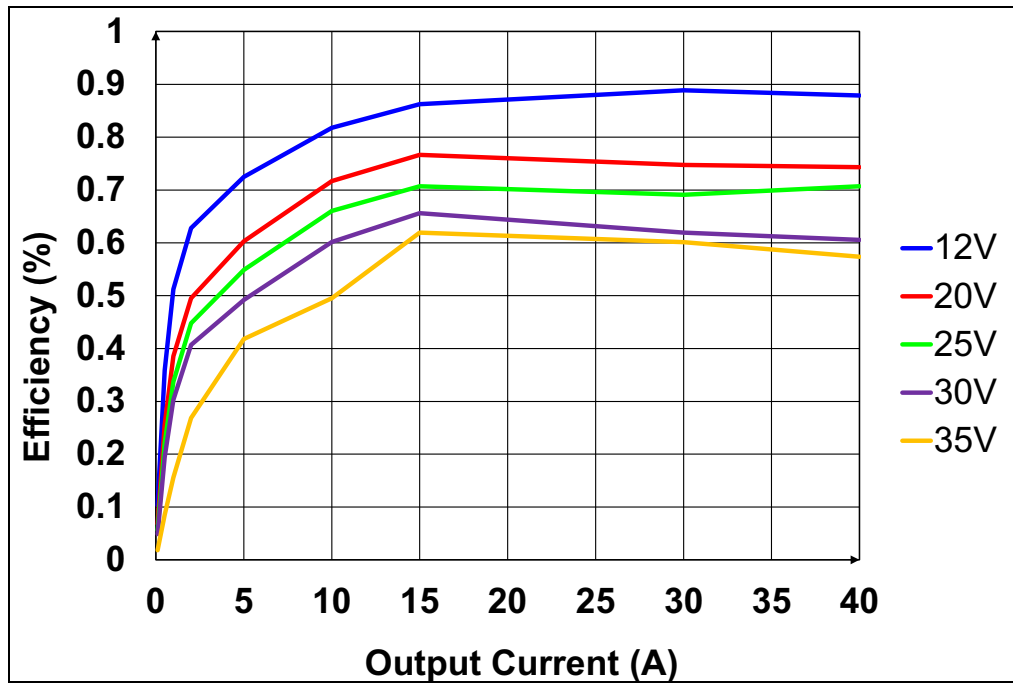

FIGURE C-10: Efficiency vs Output Current.



MICROCHIP

Worldwide Sales and Service

AMERICAS

Corporate Office
2355 West Chandler Blvd.
Chandler, AZ 85224-6199
Tel: 480-792-7200
Fax: 480-792-7277
Technical Support:
<http://www.microchip.com/support>
Web Address:
www.microchip.com

Atlanta

Duluth, GA
Tel: 678-957-9614
Fax: 678-957-1455

Austin, TX

Tel: 512-257-3370

Boston

Westborough, MA
Tel: 774-760-0087
Fax: 774-760-0088

Chicago

Itasca, IL
Tel: 630-285-0071
Fax: 630-285-0075

Dallas

Addison, TX
Tel: 972-818-7423
Fax: 972-818-2924

Detroit

Novi, MI
Tel: 248-848-4000

Houston, TX

Tel: 281-894-5983

Indianapolis

Noblesville, IN
Tel: 317-773-8323
Fax: 317-773-5453
Tel: 317-536-2380

Los Angeles

Mission Viejo, CA
Tel: 949-462-9523
Fax: 949-462-9608
Tel: 951-273-7800

Raleigh, NC

Tel: 919-844-7510

New York, NY

Tel: 631-435-6000

San Jose, CA

Tel: 408-735-9110
Tel: 408-436-4270

Canada - Toronto

Tel: 905-695-1980
Fax: 905-695-2078

ASIA/PACIFIC

Australia - Sydney
Tel: 61-2-9868-6733

China - Beijing
Tel: 86-10-8569-7000

China - Chengdu
Tel: 86-28-8665-5511

China - Chongqing
Tel: 86-23-8980-9588

China - Dongguan
Tel: 86-769-8702-9880

China - Guangzhou
Tel: 86-20-8755-8029

China - Hangzhou
Tel: 86-571-8792-8115

China - Hong Kong SAR
Tel: 852-2943-5100

China - Nanjing
Tel: 86-25-8473-2460

China - Qingdao
Tel: 86-532-8502-7355

China - Shanghai
Tel: 86-21-3326-8000

China - Shenyang
Tel: 86-24-2334-2829

China - Shenzhen
Tel: 86-755-8864-2200

China - Suzhou
Tel: 86-186-6233-1526

China - Wuhan
Tel: 86-27-5980-5300

China - Xian
Tel: 86-29-8833-7252

China - Xiamen
Tel: 86-592-2388138

China - Zhuhai
Tel: 86-756-3210040

ASIA/PACIFIC

India - Bangalore
Tel: 91-80-3090-4444

India - New Delhi
Tel: 91-11-4160-8631

India - Pune
Tel: 91-20-4121-0141

Japan - Osaka
Tel: 81-6-6152-7160

Japan - Tokyo
Tel: 81-3-6880-3770

Korea - Daegu
Tel: 82-53-744-4301

Korea - Seoul
Tel: 82-2-554-7200

Malaysia - Kuala Lumpur
Tel: 60-3-7651-7906

Malaysia - Penang
Tel: 60-4-227-8870

Philippines - Manila
Tel: 63-2-634-9065

Singapore
Tel: 65-6334-8870

Taiwan - Hsin Chu
Tel: 886-3-577-8366

Taiwan - Kaohsiung
Tel: 886-7-213-7830

Taiwan - Taipei
Tel: 886-2-2508-8600

Thailand - Bangkok
Tel: 66-2-694-1351

Vietnam - Ho Chi Minh
Tel: 84-28-5448-2100

EUROPE

Austria - Wels
Tel: 43-7242-2244-39
Fax: 43-7242-2244-393

Denmark - Copenhagen
Tel: 45-4485-5910
Fax: 45-4485-2829

Finland - Espoo
Tel: 358-9-4520-820

France - Paris
Tel: 33-1-69-53-63-20
Fax: 33-1-69-30-90-79

Germany - Garching
Tel: 49-8931-9700

Germany - Haan
Tel: 49-2129-3766400

Germany - Heilbronn
Tel: 49-7131-72400

Germany - Karlsruhe
Tel: 49-721-625370

Germany - Munich
Tel: 49-89-627-144-0
Fax: 49-89-627-144-44

Germany - Rosenheim
Tel: 49-8031-354-560

Israel - Ra'anana
Tel: 972-9-744-7705

Italy - Milan
Tel: 39-0331-742611
Fax: 39-0331-466781

Italy - Padova
Tel: 39-049-7625286

Netherlands - Drunen
Tel: 31-416-690399
Fax: 31-416-690340

Norway - Trondheim
Tel: 47-7288-4388

Poland - Warsaw
Tel: 48-22-3325737

Romania - Bucharest
Tel: 40-21-407-87-50

Spain - Madrid
Tel: 34-91-708-08-90
Fax: 34-91-708-08-91

Sweden - Gothenberg
Tel: 46-31-704-60-40

Sweden - Stockholm
Tel: 46-8-5090-4654

UK - Wokingham
Tel: 44-118-921-5800
Fax: 44-118-921-5820