

Multi CERAMOS

Enhanced optical Power LED (ThinFilm / ThinGaN)

Lead (Pb) Free Product - RoHS Compliant

LRTB C9TP



Released

Besondere Merkmale

- **Gehäusetyp:** Keramik Gehäuse für RGB-Anzeigen mit diffusem Silikon Verguss.
- **Besonderheit des Bauteils:** additive Farbmischung durch unabhängige Ansteuerung aller Chips; Kontrasterhöhung durch schwarze Oberfläche (RGB-Displays)
- **Wellenlänge:** 625 nm (rot), 528 nm (true green), 470 nm (blau)
- **Abstrahlwinkel:** Lambertscher Strahler (120°)
- **Technologie:** ThinFilm (rot), ThinGaN (true green, blau)
- **optischer Wirkungsgrad:** 45 lm/W (rot), 45 lm/W (true green), 15 lm/W (blau)
- **Gruppierungsparameter:** Lichtstärke, Wellenlänge
- **Verarbeitungsmethode:** für alle SMT-Bestücktechniken geeignet
- **Lötmethode:** Reflow Löten
- **Vorbehandlung:** nach JEDEC Level 2
- **Gurtung:** 12 mm Gurt mit 1000/Rolle, ø180 mm
- **ESD-Festigkeit:** ESD-sensitives Bauteil

Anwendungen

- Anzeigen im Innen- und Außenbereich (z.B. im Verkehrsbereich; Laufschriftanzeigen)
- Getrennte Antsteuerung der Leuchtdiodenchips zur Darstellung verschiedener Farben inklusive weiß
- Vollfarbdisplays bzw. RGB-Displays
- Hinterleuchtung (LCD, Werbebeleuchtung, Allgemeinbeleuchtung)
- Einkopplung in Lichtleiter

Features

- **package:** ceramic package for RGB-Displays with diffused silicon resin.
- **feature of the device:** additive mixture of color stimuli by independent driving of each chip; higher contrast by a black surface (RGB-Displays)
- **wavelength:** 625 nm (red), 528 nm (true green), 470 nm (blue)
- **viewing angle:** Lambertian Emitter (120°)
- **technology:** ThinFilm (red), ThinGaN (true green, blue)
- **optical efficiency:** 45 lm/W (red), 45 lm/W (true green), 15 lm/W (blue)
- **grouping parameter:** luminous intensity, wavelength
- **assembly methods:** suitable for all SMT assembly methods
- **soldering methods:** reflow soldering
- **preconditioning:** acc. to JEDEC Level 2
- **taping:** 12 mm tape with 1000/reel, ø180 mm
- **ESD-withstand voltage:** ESD sensitive Device

Applications

- indoor and outdoor displays (e.g. displays for traffic; light writing displays)
- LED chips can be controlled separately to display various colors including white
- full color displays, RGB-Displays
- backlighting (LCD, illuminated advertising, general lighting)
- coupling into light guides

Bestellinformation
Ordering Information

Typ	Emissionsfarbe	Lichtstärke ^{1) Seite 25}		
Type	Color of Emission	Luminous Intensity ^{1) page 25}		
		$I_F = 140 \text{ mA}$		
		$I_V \text{ (mcd)}$		
		red	true green	blue
LRTB C9TP	red true green blue	2.800...8.000	5.000 ...14.000	1.400 ...5.000

Bestellinformation
Ordering Information

Typ	Bestellnummer
Type	Ordering Code
LRTB C9TP-CWD5-1+D5E7-25+A9C5-49	Q65110A8879
LRTB C9TP-CWD5-1+D5E7-25+A7CW-49	Q65111A2182

Anm.: Die oben genannten Typbezeichnungen umfassen die bestellbaren Selektionen. Diese bestehen aus wenigen Helligkeitsgruppen (siehe **Seite 7** für nähere Informationen). Es wird nur eine einzige Helligkeitsgruppe pro Gurt geliefert. Z.B.: LRTB C9TP-CWD5-1+D5E7-25+A9C5-49 bedeutet, dass auf dem Gurt nur eine der Helligkeitsgruppen CW, C5, C7, C9, DW oder D5 enthalten ist.

Um die Liefersicherheit zu gewährleisten, können einzelne Helligkeitsgruppen nicht bestellt werden.

Gleiches gilt für die Farben, bei denen Wellenlängengruppen gemessen und gruppiert werden. Pro Gurt wird nur eine Wellenlängengruppe geliefert. Z.B.: LRTB C9TP-CWD5-1+D5E7-25+A9C5-49 bedeutet, dass auf dem Gurt nur eine der Wellenlängengruppen -2, -3, -4 oder -5 enthalten ist (siehe **Seite 8** für nähere Information). Z.B.: LRTB C9TP-CWD5-1+D5E7-25+A9C5-49 bedeutet, dass das Bauteil innerhalb der auf **Seite 4** spezifizierten Grenzen geliefert wird.

Um die Liefersicherheit zu gewährleisten, können einzelne Wellenlängengruppen nicht bestellt werden.

Note: The above Type Numbers represent the order groups which include only a few brightness groups (see **page 7** for explanation). Only one group will be shipped on each reel (there will be no mixing of two groups on each reel). E.g. LRTB C9TP-CWD5-1+D5E7-25+A9C5-49 means that only one group CW, C5, C7, C9, DW or D5 will be shippable for any one reel. In order to ensure availability, single brightness groups will not be orderable.

In a similar manner for colors where wavelength groups are measured and binned, single wavelength groups will be shipped on any one reel. E.g. LRTB C9TP-CWD5-1+D5E7-25+A9C5-49 means that only 1 wavelength group -2, -3, -4 or -5 will be shippable (see **page 8** for explanation). E.g. LRTB C9TP-CWD5-1+D5E7-25+A9C5-49 means that the device will be shipped within the specified limits as stated on **page 4**. In order to ensure availability, single wavelength groups will not be orderable.

Grenzwerte
Maximum Ratings

Bezeichnung Parameter	Symbol Symbol	Werte Values			Einheit Unit
		red	true green	blue	
Betriebstemperatur (auf PC-Board FR4/G30) Operating temperature range (on PC-Board FR4/G30)	T_{op}	- 40 ... + 110*			°C
Lagertemperatur Storage temperature range	T_{stg}	- 40 ... + 110			°C
Sperrschichttemperatur Junction temperature	T_j	+ 150			°C
Durchlassstrom (min.) Forward current (max.) ($T_S=25^\circ\text{C}$)	I_F I_F	30 250			mA
Stoßstrom Surge current $t_p = 10 \mu\text{s}$, $D = 0.005$, $T_S=25^\circ\text{C}$	I_{FM}	1000	750	750	mA
Sperrspannung ^{2) Seite 25} Reverse voltage ^{2) page 25} ($T_S=25^\circ\text{C}$)	V_R	12	5		V

*auf Grund von unterschiedlichen thermischen Ausdehnungskoeffizienten nicht empfehlenswert für MCPCB
on MCPCB not recommended due to thermal mismatch issue

Kennwerte
Characteristics
 $(T_S = 25\text{ °C})$

Bezeichnung Parameter	Symbol Symbol	Werte Values			Einheit Unit
		red	true green	blue	
Wellenlänge des emittierten Lichtes Wavelength at peak emission $I_F = 140\text{ mA}$	(typ.) λ_{peak}	632	523	465	nm
Dominantwellenlänge ^{3) Seite 25} Dominant wavelength ^{3) page 25} $I_F = 140\text{ mA}$	(min.) λ_{dom} (typ.) (max.)	619 625 631	518 528* 544	459 470* 476.5	nm nm nm
Spektrale Bandbreite bei 50 % $I_{\text{rel max}}$ Spectral bandwidth at 50 % $I_{\text{rel max}}$ $I_F = 140\text{ mA}$	(typ.) $\Delta\lambda$	18	33	25	nm
Abstrahlwinkel bei 50 % I_V (Vollwinkel) Viewing angle at 50 % I_V	(typ.) 2ϕ	120	120	120	Grad deg.
Durchlassspannung ^{4) Seite 25} Forward voltage ^{4) page 25} $I_F = 140\text{ mA}$	(min.) V_F (typ.) V_F (max.) V_F	1.9 2.1 2.65	2.9 3.4 4.1	2.9 3.3 4.1	V V V
Sperrstrom Reverse current $V_R = 5\text{ V}$ (blue / true green); 12 V (red)	(typ.) I_R (max.) I_R	0.01 10	0.01 10	0.01 10	μA μA
Wärmewiderstand Thermal resistance Sperrschicht/Lötchip 1 chip on Junction/solder point 1 chip on	(typ.) $R_{\text{th JS}}$ (max.) $R_{\text{th JS}}$		41 55		K/W K/W
Sperrschicht/Lötchip 3 chip on Junction/solder point 3 chip on	(typ.) $R_{\text{th JS}}$ (max.) $R_{\text{th JS}}$		50** 82**		K/W K/W

* Einzelgruppen siehe Seite 8
Individual groups on page 8

** R_{th} (max) basiert auf statistischen Werten
 R_{th} (max) is based on statistic values

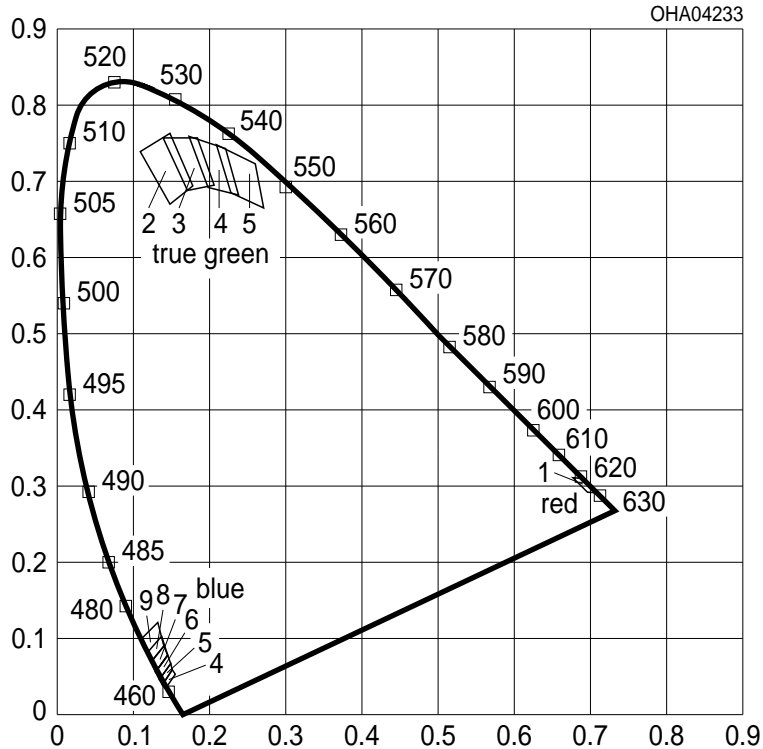

Gruppe Group	Cx	Cy	Gruppe Group	Cx	Cy
2	0.109	0.739	4	0.146	0.029
	0.148	0.670		0.157	0.047
	0.178	0.694		0.152	0.058
	0.148	0.763		0.139	0.038
3	0.139	0.757	5	0.142	0.034
	0.171	0.688		0.155	0.053
	0.206	0.695		0.149	0.065
	0.184	0.757		0.135	0.044
4	0.173	0.759	6	0.138	0.039
	0.198	0.692		0.151	0.059
	0.238	0.682		0.145	0.075
	0.221	0.743		0.129	0.053
5	0.209	0.748	7	0.134	0.046
	0.228	0.685		0.149	0.067
	0.271	0.665		0.141	0.087
	0.260	0.723		0.123	0.065
1	0.689	0.310	8	0.129	0.056
	0.677	0.311		0.145	0.078
	0.696	0.292		0.137	0.103
	0.709	0.291		0.118	0.081
			9	0.122	0.068
				0.140	0.090
				0.132	0.121
				0.110	0.099

Anm.: Die Farbkoordinaten des Mischlichtes können innerhalb des gekennzeichneten Bereichs des Farbdreiecks erwartet werden.
 Note: The color coordinates of the mixed light can be expected within the marked area of the color triangle

Floating Bins

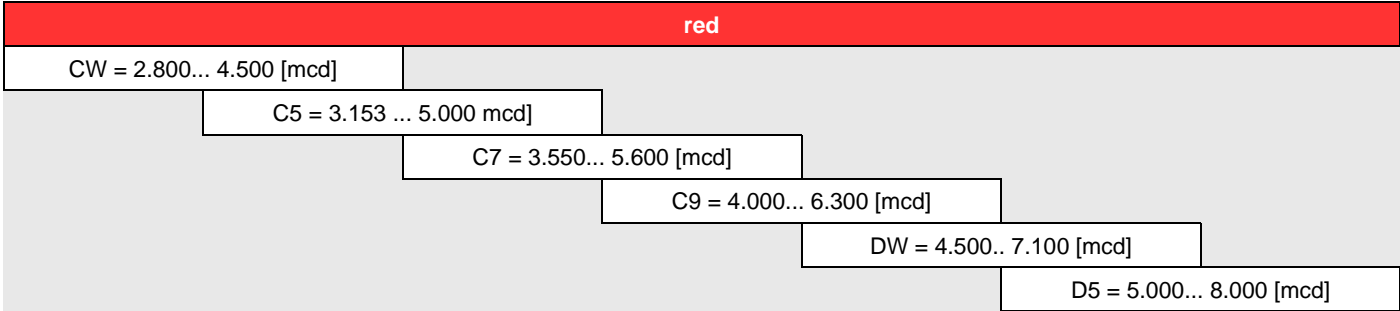

Floating Bins

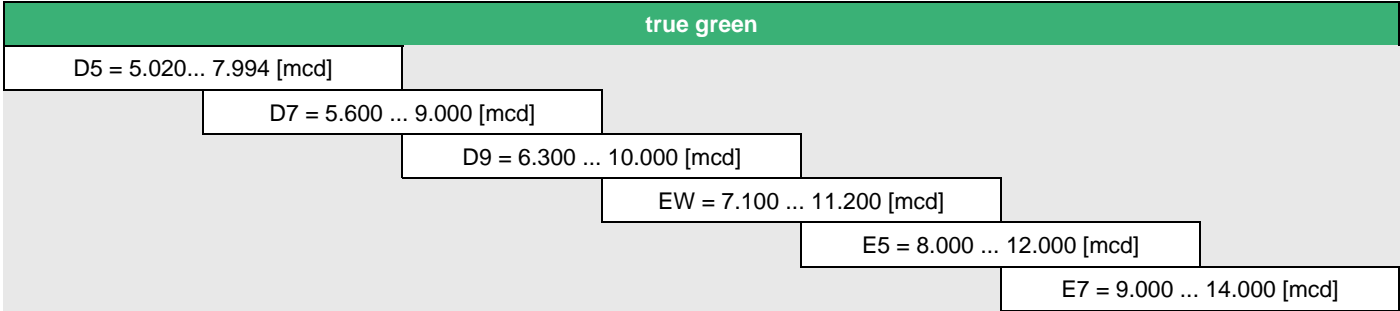

Floating Bins

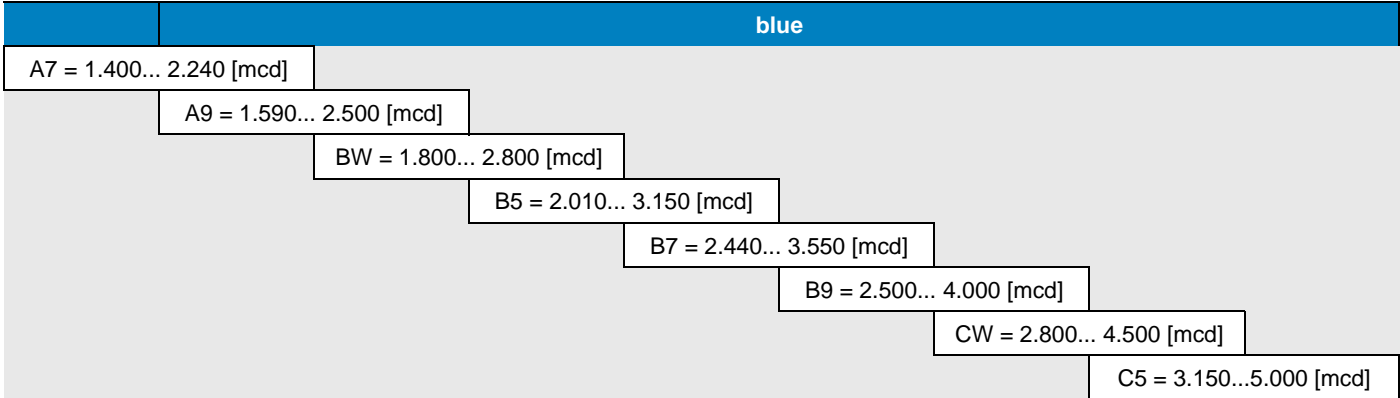

Wellenlängengruppen (Dominantwellenlänge)³⁾ Seite 25
Wavelength Groups (Dominant Wavelength)³⁾ page 25

Gruppe Group	true green		Einheit Unit
	min.	max.	
2	518	526	nm
3	524	532	nm
4	530	538	nm
5	536	544	nm

Gruppe Group	blue		Einheit Unit
	min.	max.	
4	459.0	463.5	nm
5	461.5	466.0	nm
6	464.0	468.5	nm
7	466.5	471.0	nm
8	469.0	473.5	
9	471.5	476.0	

Gruppenbezeichnung auf Etikett

Group Name on Label

Beispiel: CW-1+DW-2+A79-3

Example: CW-1+DW-2+A9-3

Helligkeits- gruppe Brightness Group (red)	Wellenlänge (keine Gruppierung) Wavelength (no grouping) (red)	Helligkeits- gruppe Brightness Group (true green)	Wellenlänge Wavelength (true green)	Helligkeits- gruppe Brightness Group (blue)	Wellenlänge Wavelength (blue)
CW	1	D5	2	A9	4

Anm.: In einer Verpackungseinheit / Gurt ist immer nur eine Helligkeitsgruppe pro Farbe enthalten.

Note: No packing unit / tape ever contains more than one brightness group per color.

Relative spektrale Emission^{5) Seite 25}

Relative Spectral Emission^{5) page 25}

$V(\lambda)$ = spektrale Augenempfindlichkeit / Standard eye response curve

$I_{rel} = f(\lambda)$; $T_S = 25\text{ °C}$; $I_F = 140\text{ mA}$

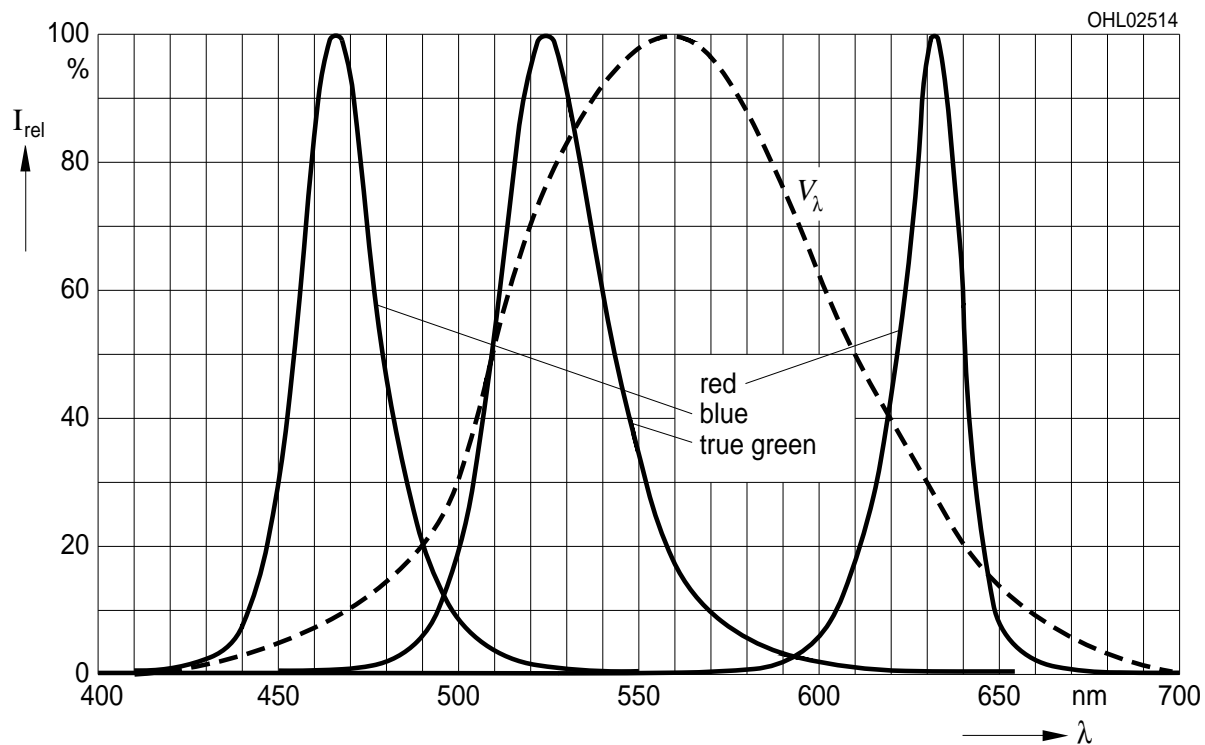

Abstrahlcharakteristik^{5) Seite 25}

Radiation Characteristic^{5) page 25}

$I_{rel} = f(\varphi)$; $T_S = 25\text{ °C}$

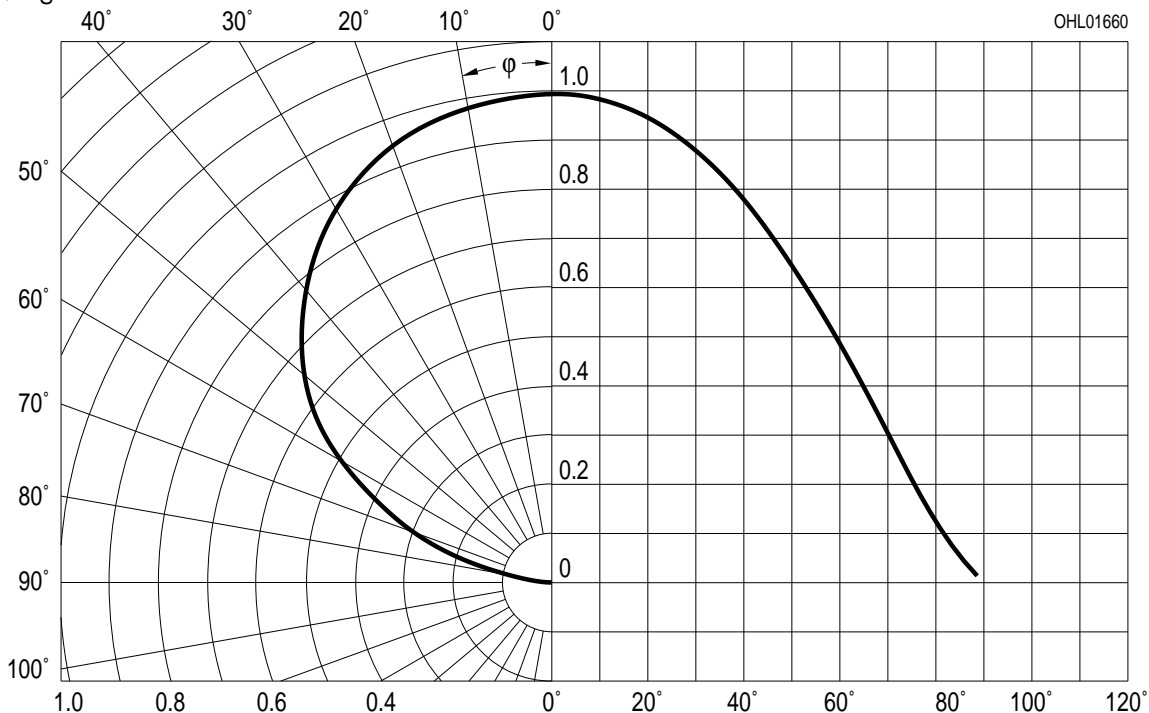

Durchlassstrom
Forward Current

$I_F = f(V_F); T_S = 25\text{ °C}$, red

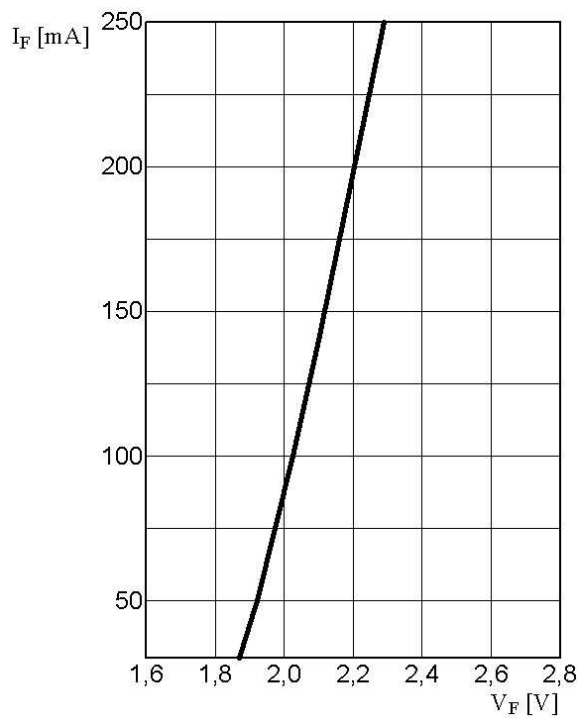

Durchlassstrom
Forward Current

$I_F = f(V_F); T_S = 25\text{ °C}$, true green

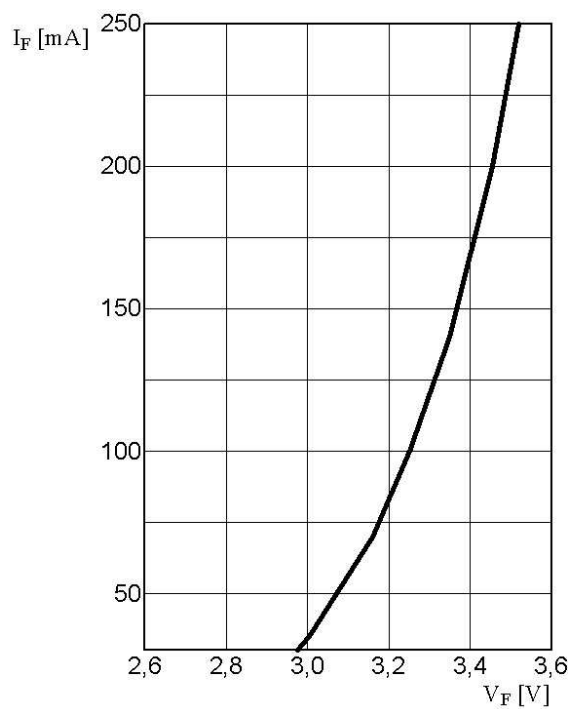

Durchlassstrom
Forward Current

$I_F = f(V_F); T_S = 25\text{ °C}$, blue

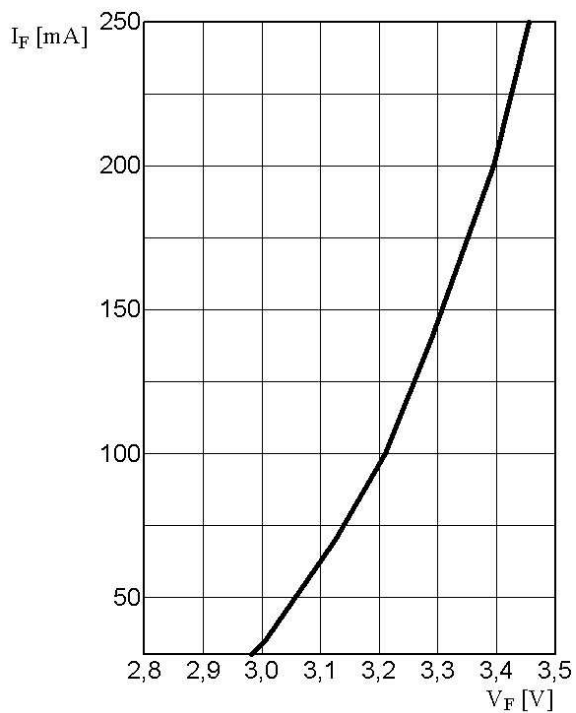

Relative Lichtstärke⁶⁾ Seite 25

Relative Luminous Intensity⁶⁾ page 25

$I_V/I_V(140\text{ mA}) = f(I_F); T_S = 25\text{ °C}; \text{red}$

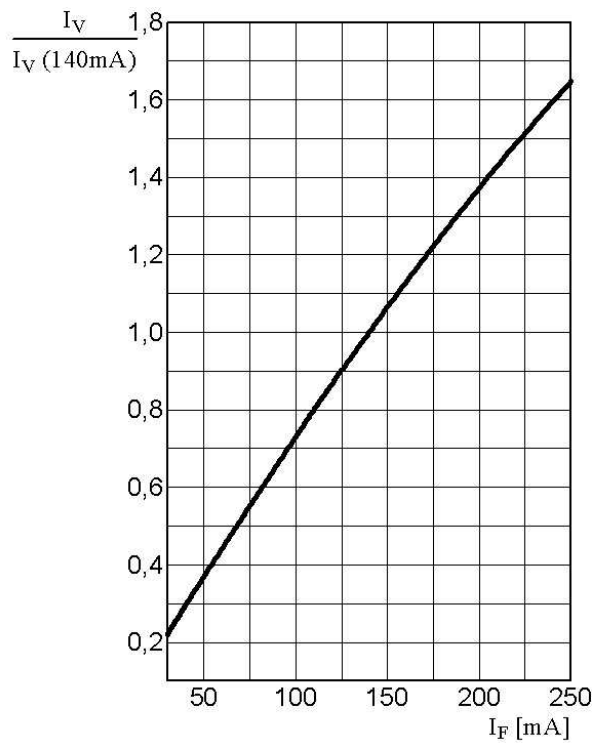

Relative Lichtstärke⁶⁾ Seite 25

Relative Luminous Intensity⁶⁾ page 25

$I_V/I_V(140\text{ mA}) = f(I_F); T_S = 25\text{ °C}; \text{true green}$

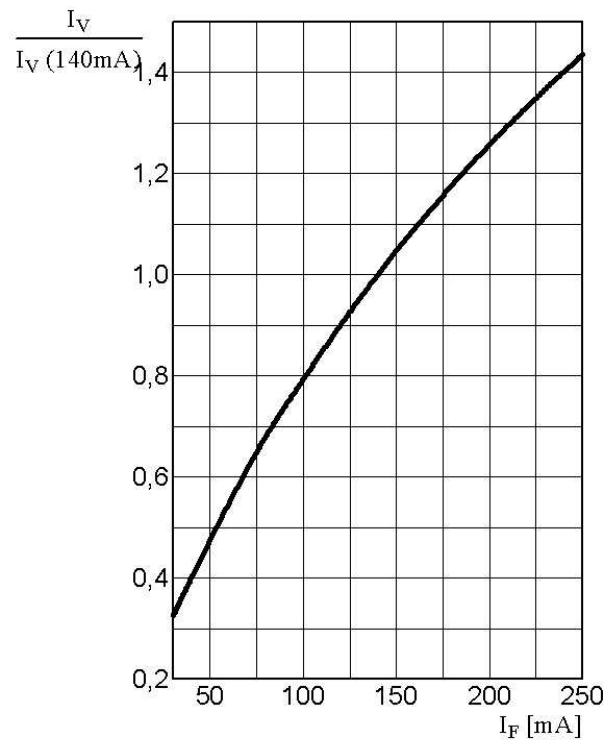

Relative Lichtstärke⁶⁾ Seite 25

Relative Luminous Intensity⁶⁾ page 25

$I_V/I_V(140\text{ mA}) = f(I_F); T_S = 25\text{ °C}; \text{blue}$

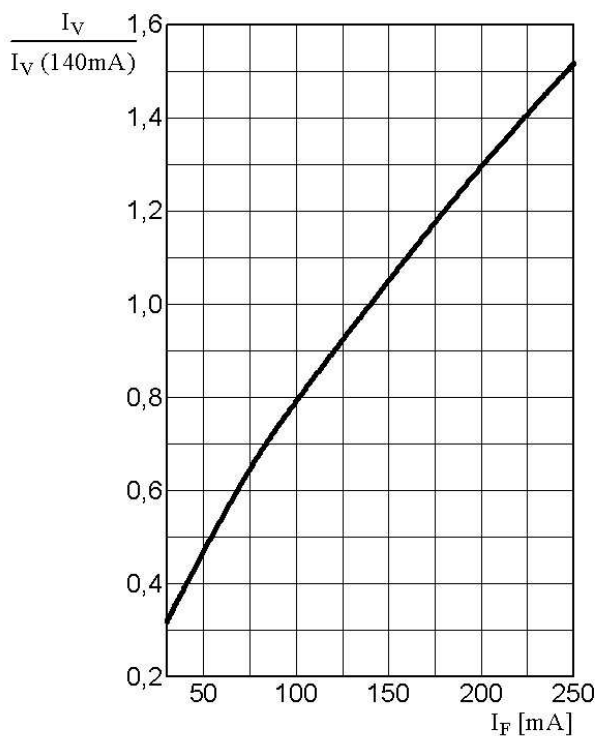

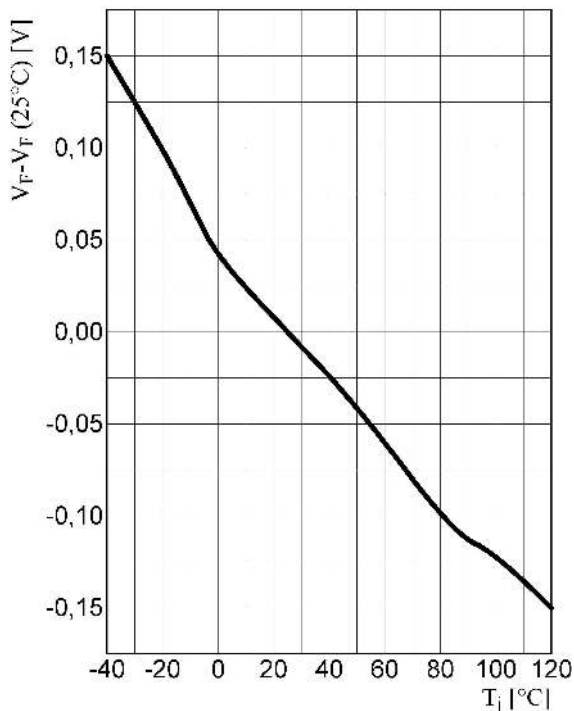
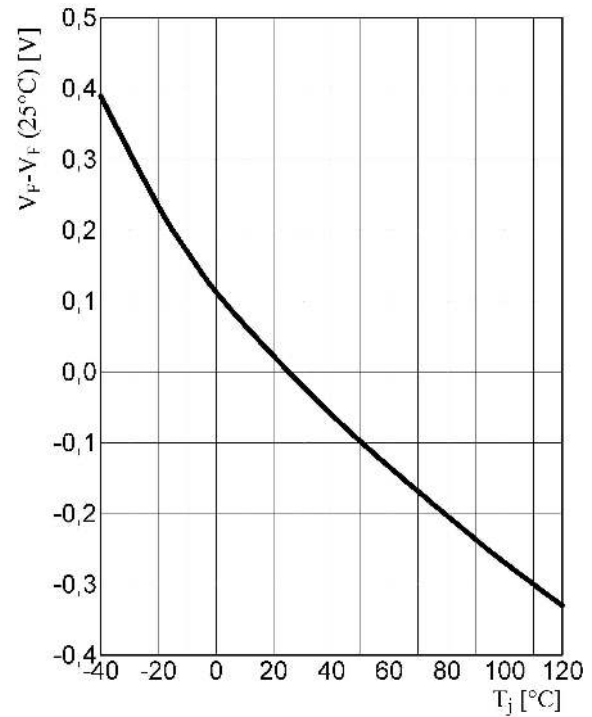
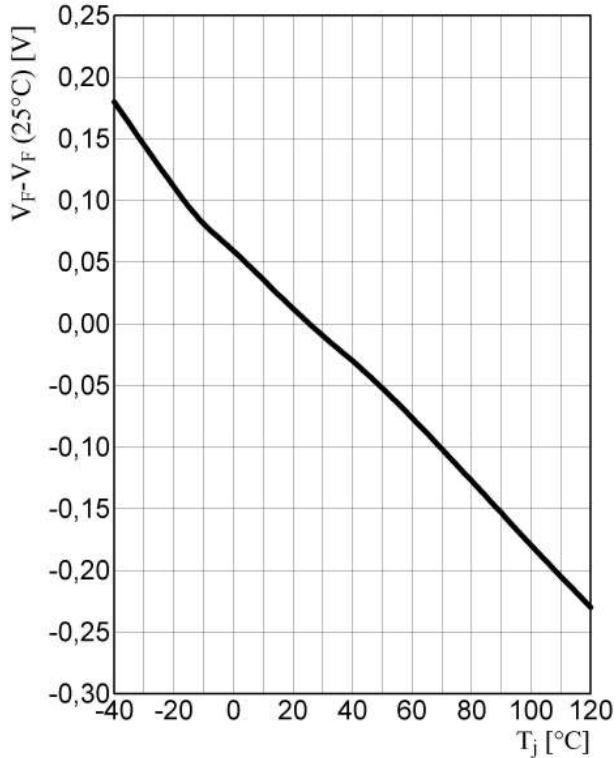
Relative Vorwärtsspannung**Relative Forward Voltage** $\Delta V_F = V_F - V_F(25^\circ\text{C})$; $I_F = 140\text{ mA}$, red**Relative Vorwärtsspannung****Relative Forward Voltage** $\Delta V_F = V_F - V_F(25^\circ\text{C})$; $I_F = 140\text{ mA}$, true green**Relative Vorwärtsspannung****Relative Forward Voltage** $\Delta V_F = V_F - V_F(25^\circ\text{C})$; $I_F = 140\text{ mA}$, blue

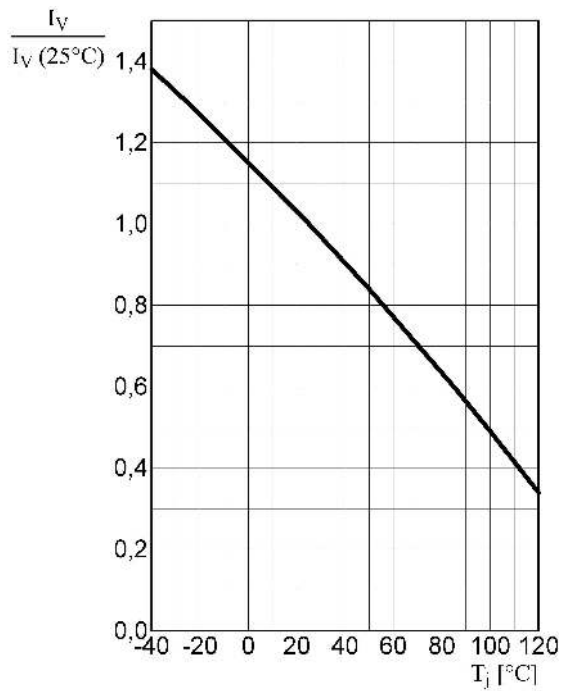
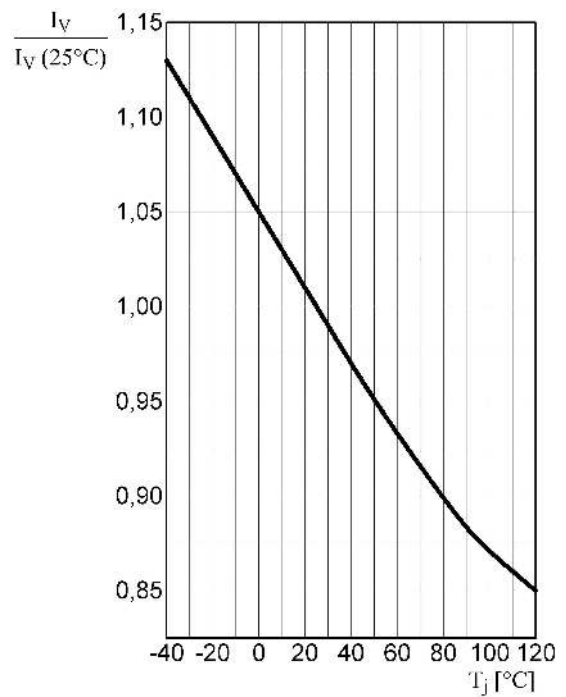
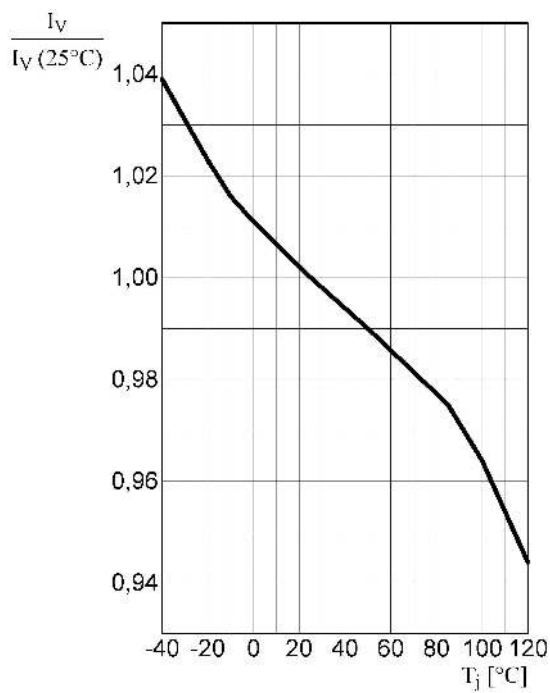
Relative Lichtstärke**Relative Luminous Intensity** $I_V/I_V(25\text{ °C}) = f(T_j); I_F = 140\text{ mA}$, red**Relative Lichtstärke****Relative Luminous Intensity** $I_V/I_V(25\text{ °C}) = f(T_j); I_F = 140\text{ mA}$, true green**Relative Lichtstärke****Relative Luminous Intensity** $I_V/I_V(25\text{ °C}) = f(T_j); I_F = 140\text{ mA}$, blue

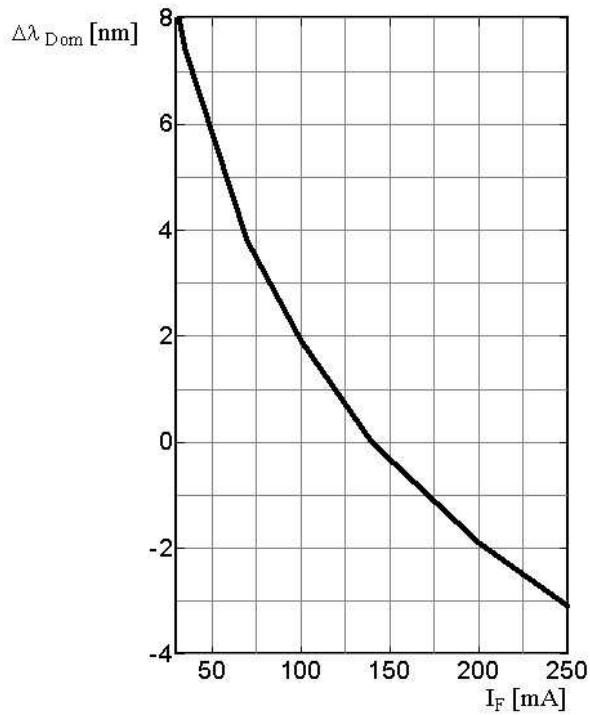
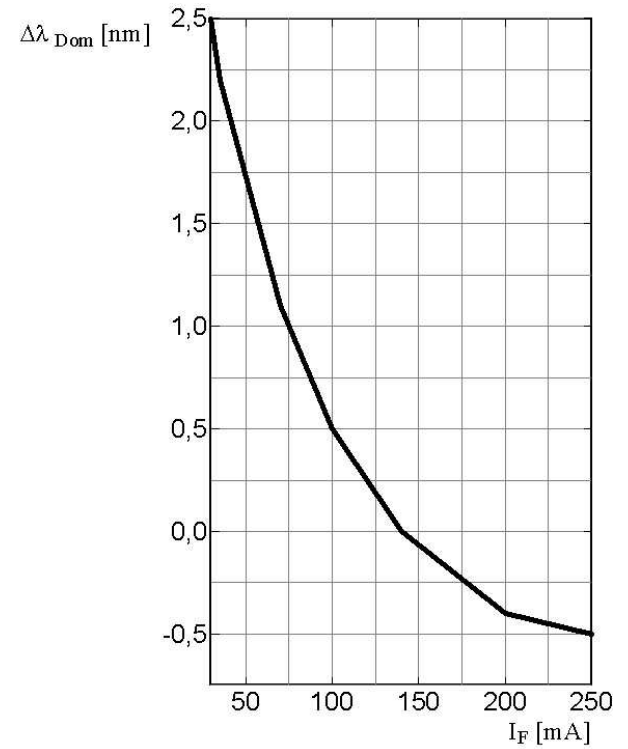
Relative Dominante Wellenlänge**Relative Dominant Wavelength** $\Delta\lambda_{\text{dom}} = f(I_F); T_S = 25\text{ °C}; \text{ true green}$ **Relative Dominante Wellenlänge****Relative Dominant Wavelength** $\Delta\lambda_{\text{dom}} = f(I_F); T_S = 25\text{ °C}; \text{ blue}$ 

Relative Dominante Wellenlänge**Relative Dominant Wavelength**

$$\Delta\lambda_{\text{dom}} = f(T_j); I_F = 140 \text{ mA, red}$$

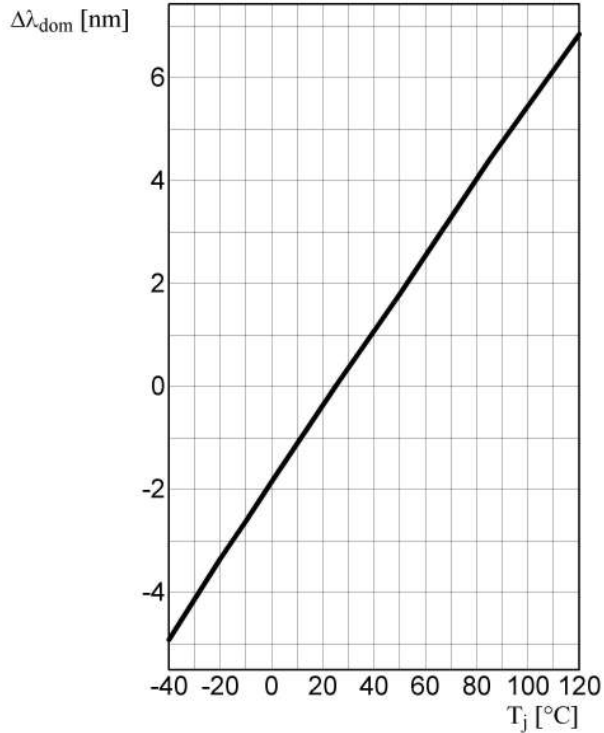
**Relative Dominante Wellenlänge****Relative Dominant Wavelength**

$$\Delta\lambda_{\text{dom}} = f(T_j); I_F = 140 \text{ mA, true green}$$

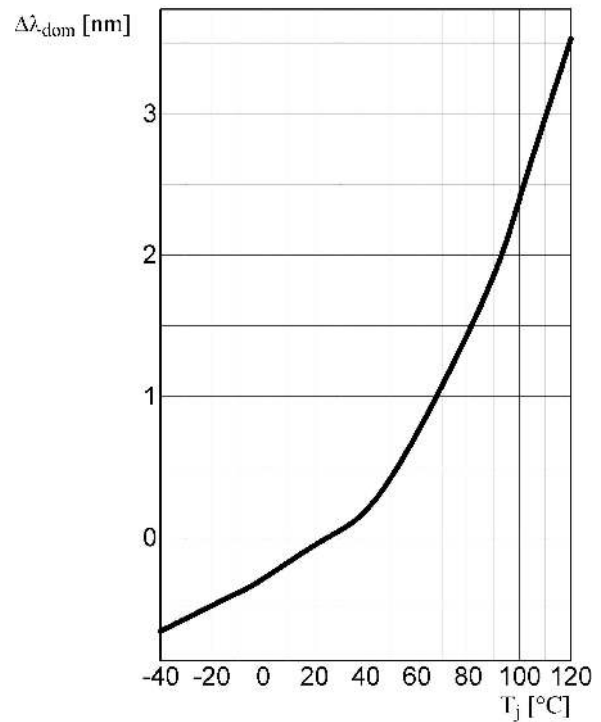
**Relative Dominante Wellenlänge****Relative Dominant Wavelength**

$$\Delta\lambda_{\text{dom}} = f(T_j); I_F = 140 \text{ mA, blue}$$

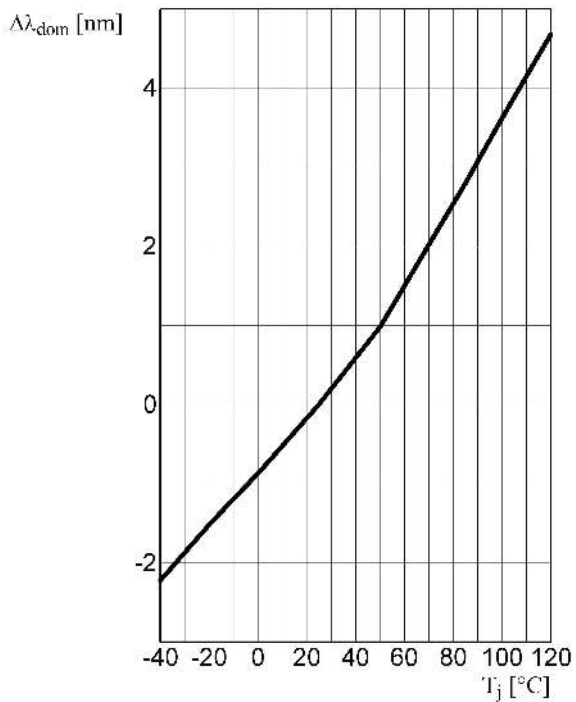

Maximal zulässiger Durchlassstrom
Max. Permissible Forward Current

$I_F = f(T_S)$; (1 chip on); red

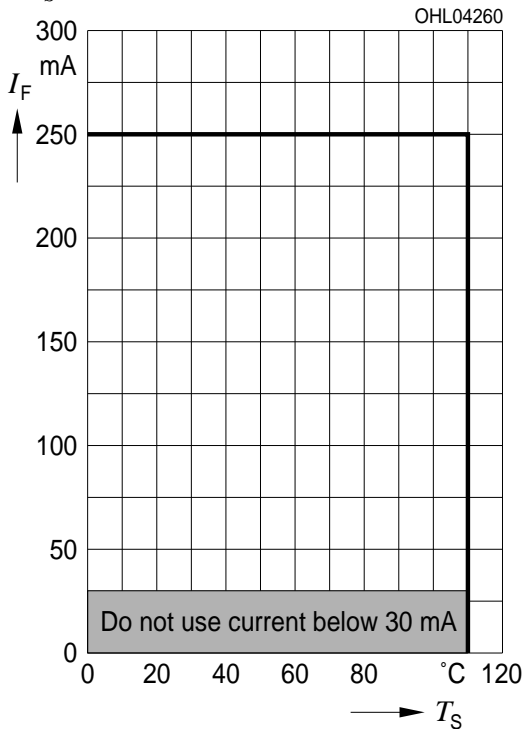

Maximal zulässiger Durchlassstrom
Max. Permissible Forward Current

$I_F = f(T_S)$; (3 chips on); red

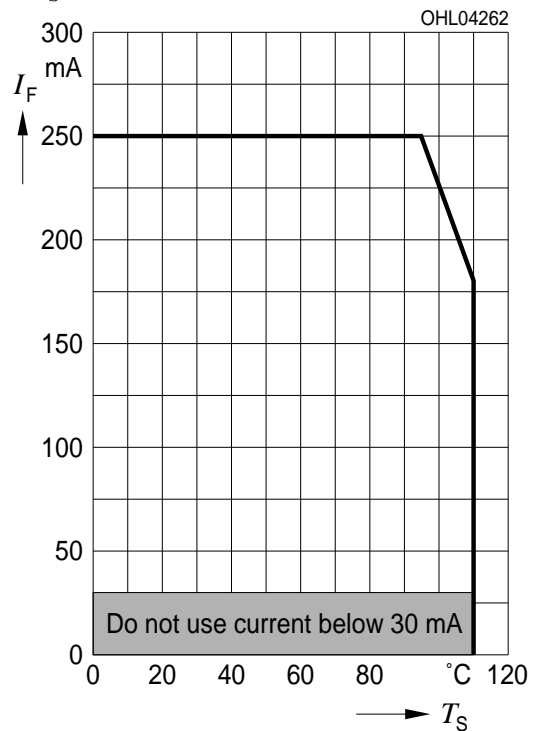

Maximal zulässiger Durchlassstrom
Max. Permissible Forward Current

$I_F = f(T_S)$; (1 chip on); true green, blue

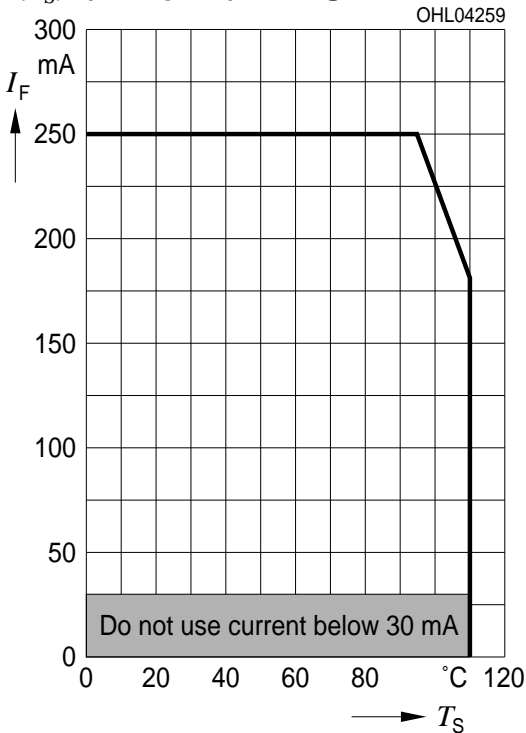

Maximal zulässiger Durchlassstrom
Max. Permissible Forward Current

$I_F = f(T_S)$; (3 chips on); true green, blue

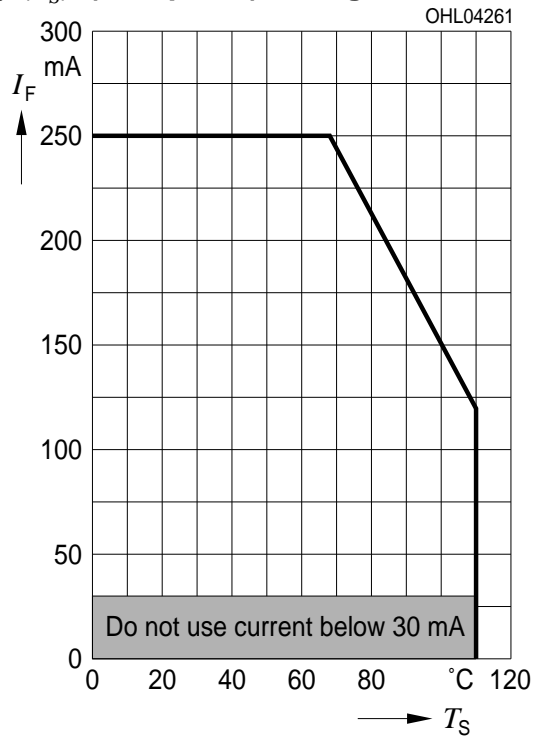

Zulässige Impulsbelastbarkeit
Permissible Pulse Handling Capability

Duty cycle $D =$ parameter, $T_S = 25\text{ °C}$

$I_F = f(t_p)$; (1 Chip on); red

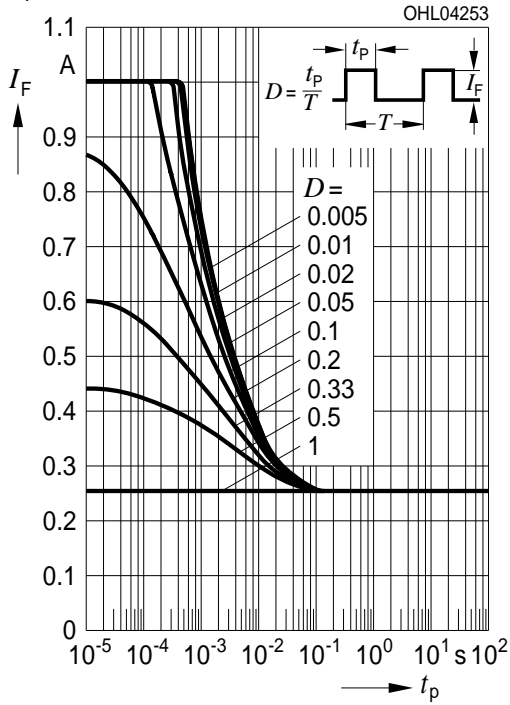

Zulässige Impulsbelastbarkeit
Permissible Pulse Handling Capability

Duty cycle $D =$ parameter, $T_S = 85\text{ °C}$

$I_F = f(t_p)$; (1 Chip on); red

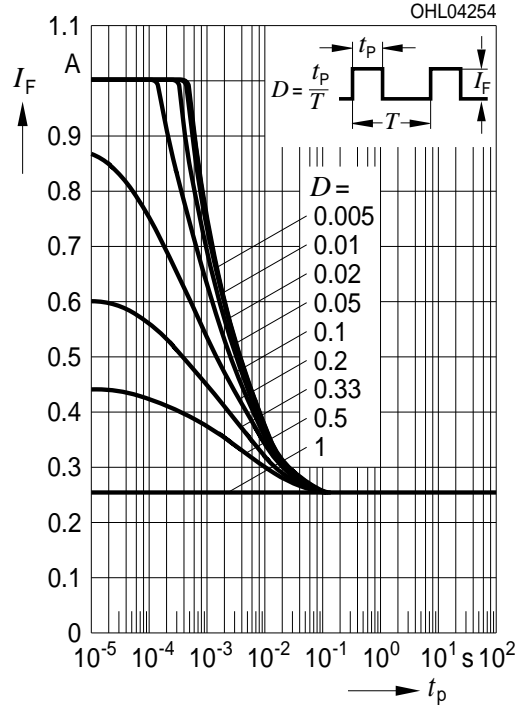

Zulässige Impulsbelastbarkeit
Permissible Pulse Handling Capability

Duty cycle $D =$ parameter, $T_S = 25\text{ °C}$

$I_F = f(t_p)$; (1 Chip on); true green, blue

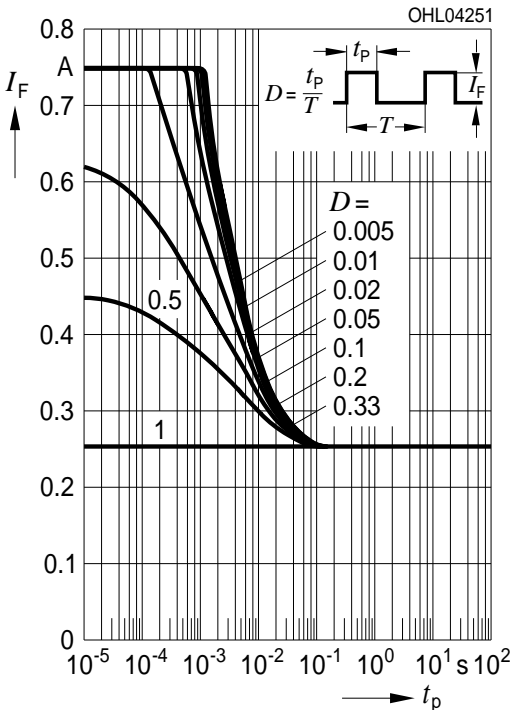

Zulässige Impulsbelastbarkeit
Permissible Pulse Handling Capability

Duty cycle $D =$ parameter, $T_S = 85\text{ °C}$

$I_F = f(t_p)$; (1 Chip on); true green, blue

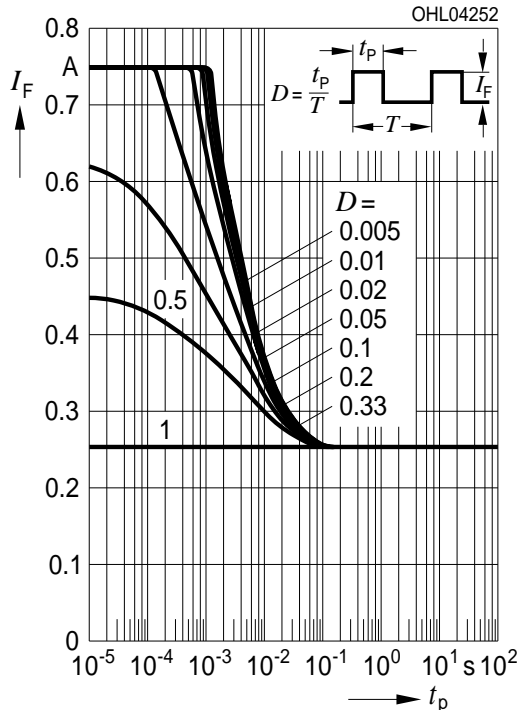

Zulässige Impulsbelastbarkeit
Permissible Pulse Handling Capability

Duty cycle $D =$ parameter, $T_S = 25\text{ °C}$

$I_F = f(t_p)$; (3 Chip on); red

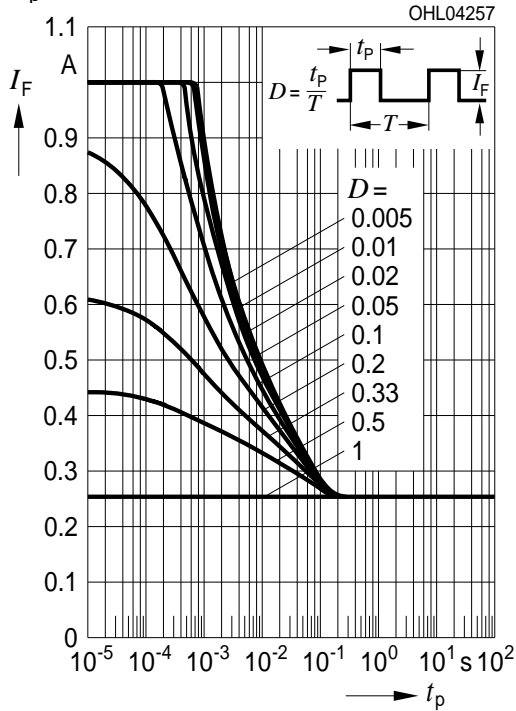

Zulässige Impulsbelastbarkeit
Permissible Pulse Handling Capability

Duty cycle $D =$ parameter, $T_S = 85\text{ °C}$

$I_F = f(t_p)$; (3 Chip on); red

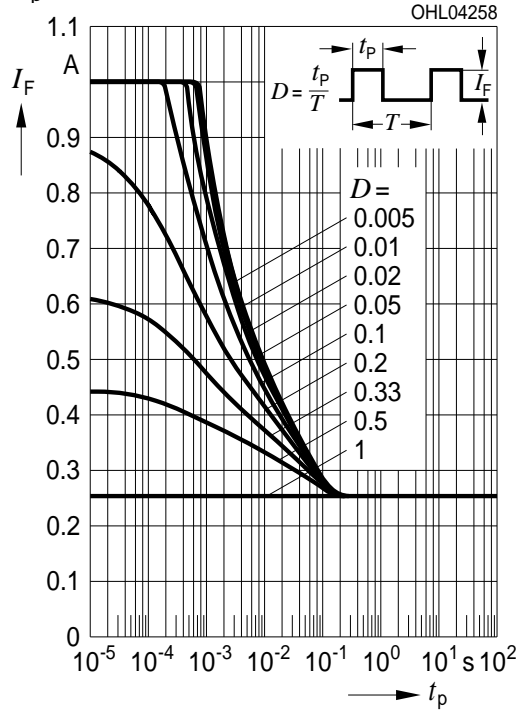

Zulässige Impulsbelastbarkeit
Permissible Pulse Handling Capability

Duty cycle $D =$ parameter, $T_S = 25\text{ °C}$

$I_F = f(t_p)$; (3 Chip on); true green, blue

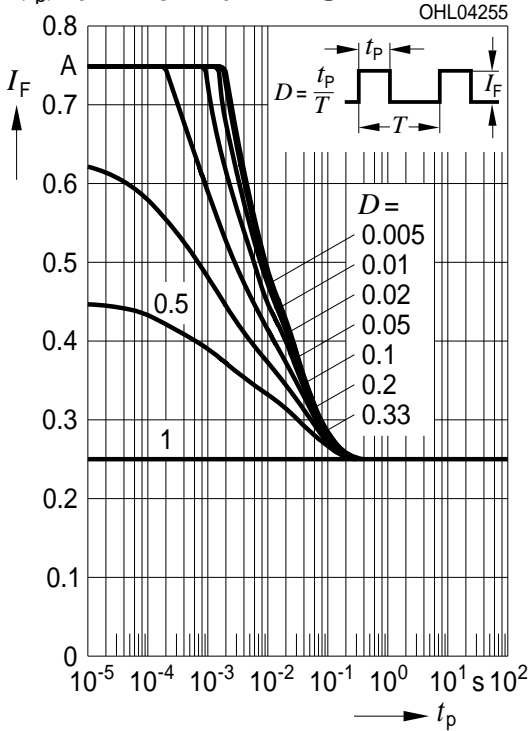

Zulässige Impulsbelastbarkeit
Permissible Pulse Handling Capability

Duty cycle $D =$ parameter, $T_S = 85\text{ °C}$

$I_F = f(t_p)$; (3 Chip on); true green, blue

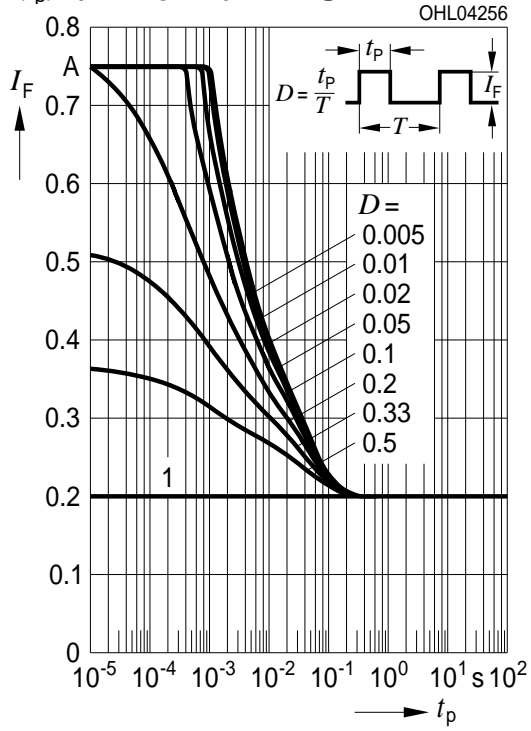

Maßzeichnung⁶⁾ Seite 25
 Package Outlines⁶⁾ page 25

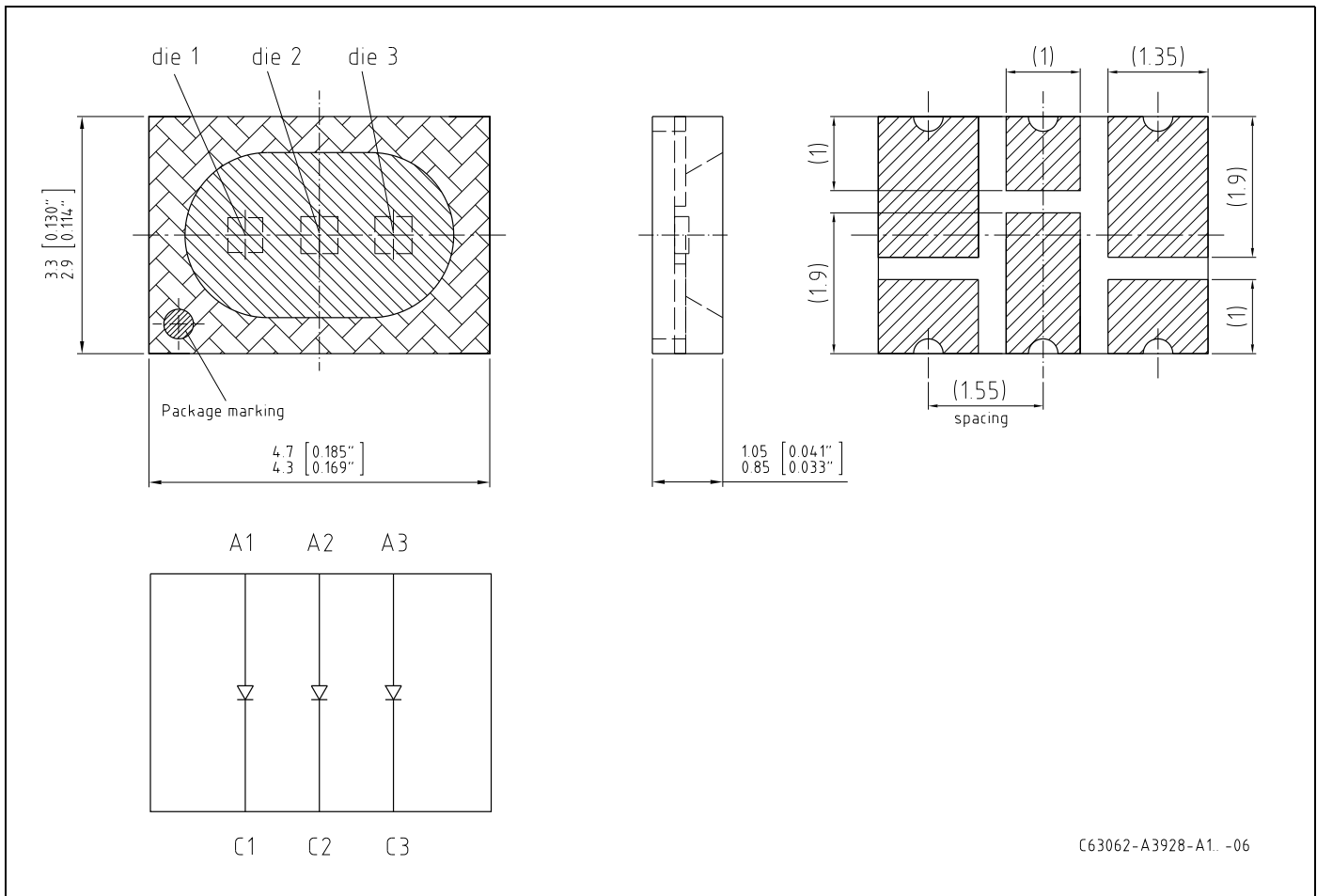

C1	Cathode	Red (R)
A1	Anode	Red (R)
C2	Cathode	True Green (T)
A2	Anode	True Green (T)
C3	Cathode	Blue (B)
A3	Anode	Blue (B)

Gewicht / Approx. weight:

45 mg

Gurtung / Polarität und Lage⁶⁾ Seite 25

Verpackungseinheit 1000/Rolle, ø180 mm

Method of Taping / Polarity and Orientation⁶⁾ page 25

Packing unit 1000/reel, ø180 mm

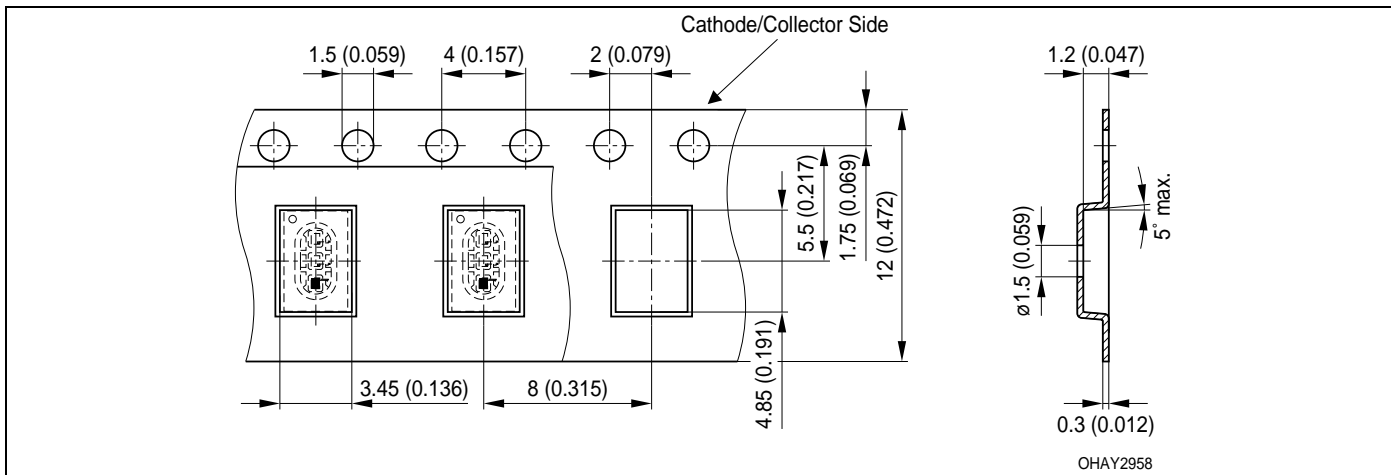

Empfohlenes Lötpadding^{6) 7)} Seite 25
 Recommended Solder Pad^{6) 7)} page 25

Reflow Lötén
 Reflow Soldering

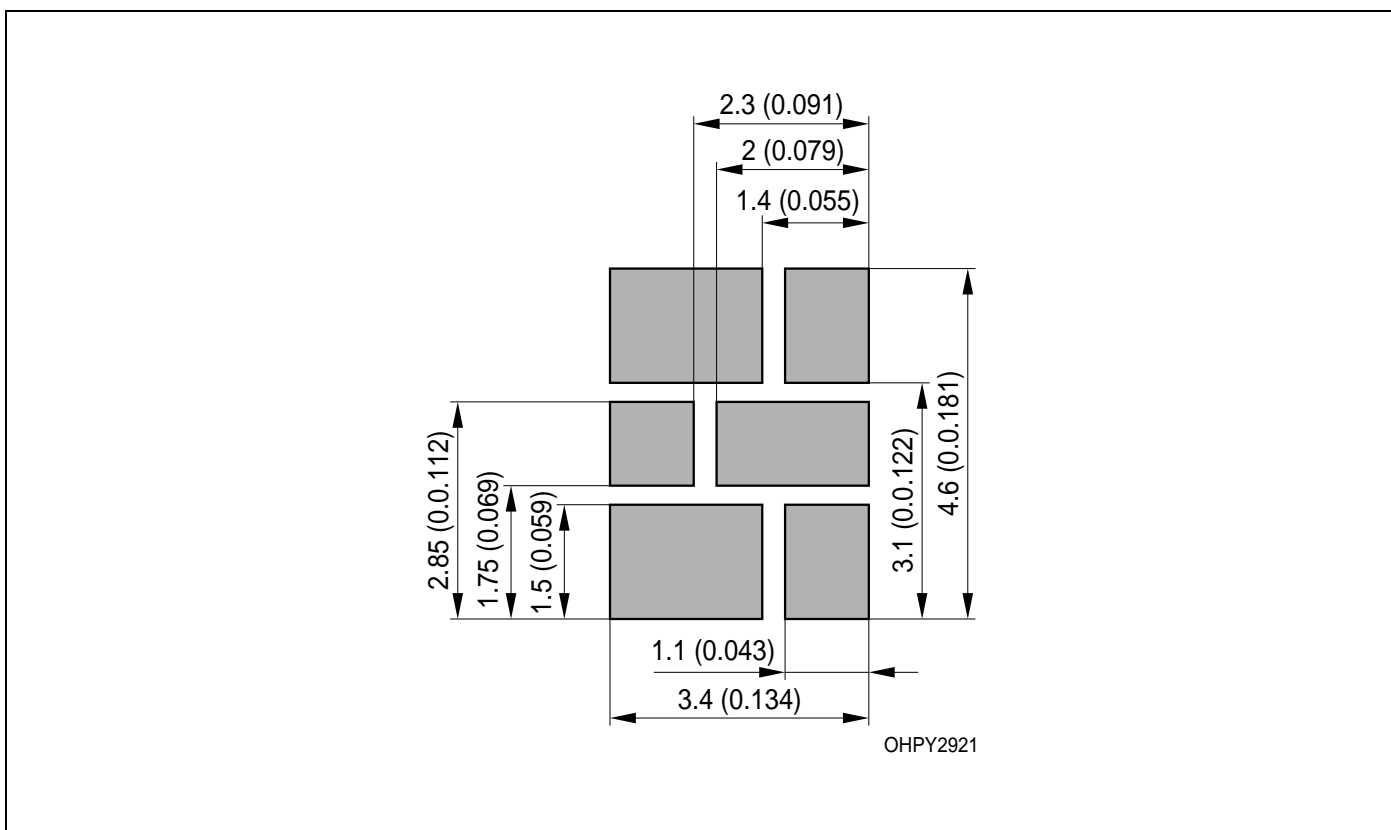

Lötbedingungen Soldering Conditions

Vorbehandlung nach JEDEC Level 2
Preconditioning acc. to JEDEC Level 2

Reflow Lötprofil für bleifreies Löten Reflow Soldering Profile for lead free soldering

(nach J-STD-020D.01)
(acc. to J-STD-020D.01)

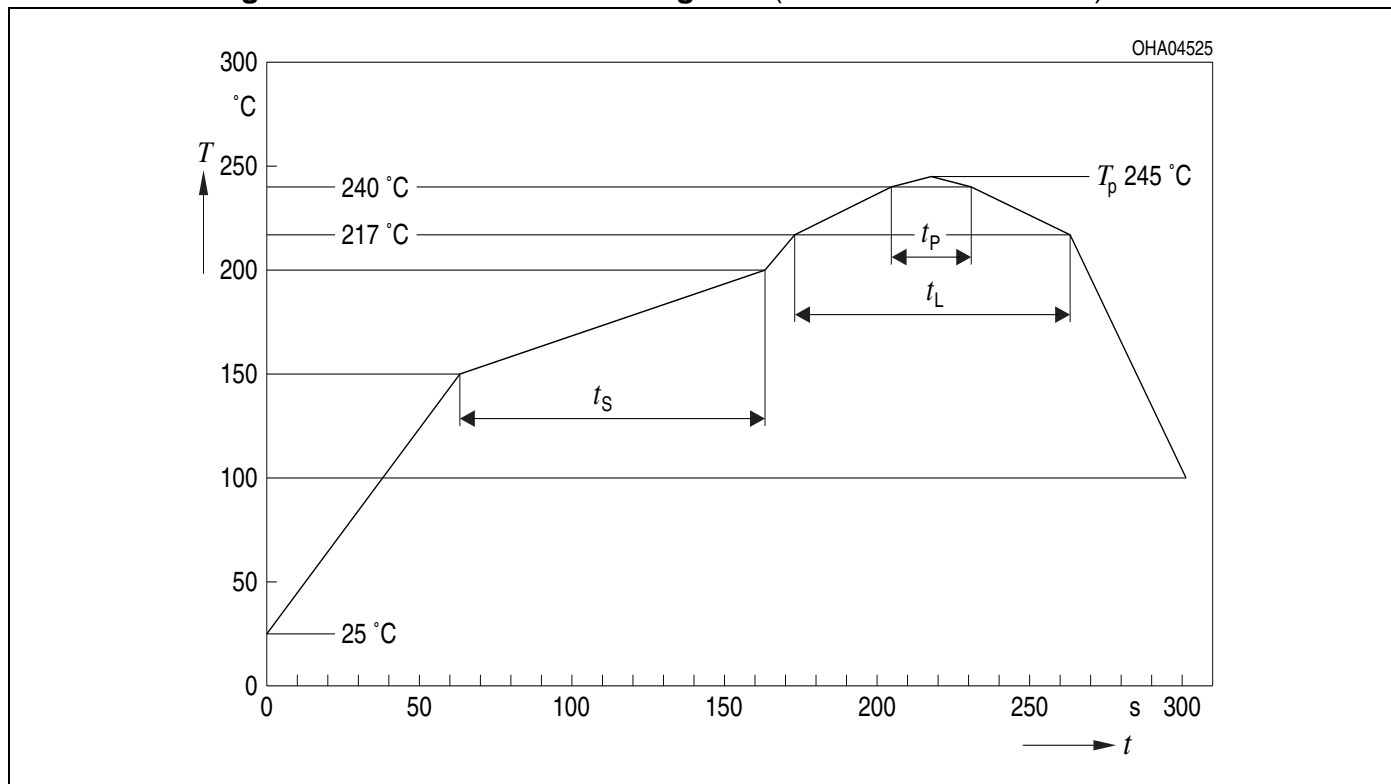

Profile Feature	Pb-Free (SnAgCu) Assembly	
	Recommendation	Max. Ratings
Ramp-up Rate to Preheat*) 25°C to 150°C	2°C / sec	3°C / sec
Time t_s from T_{Smin} to T_{Smax} (150°C to 200°C)	100s	min. 60sec max. 120sec
Ramp-up Rate to Peak*) 180°C to T_p	2°C / sec	3°C / sec
Liquidus Temperature T_L	217°C	
Time t_L above T_L	80sec	max. 100sec
Peak Temperature T_p	245°C	max. 260°C
Time t_p within 5°C of the specified peak temperature $T_p - 5K$	20sec	min. 10sec max. 30sec
Ramp-down Rate* T_p to 100°C	3K / sec	6K / sec maximum
Time 25°C to Peak temperature		max. 8 min.

All temperatures refer to the center of the package, measured on the top of the component

* slope calculation $\Delta T/\Delta t$: Δt max. 5 sec; fulfillment for the whole T-range

Barcode-Produkt-Etikett (BPL)
Barcode-Product-Label (BPL)

OSRAM Opto Semiconductors

(6P) BATCH NO: 1004109518



(1T) LOT NO: 1234567890



(X) PROD NO: 11055131





LRTBGFTG BIN1: U5-1-0-20
6-LEAD MULTILED BIN2: V9-5-0-20
RoHS Compliant BIN3: S7-6-0-20

ML Temp ST
4 260 °C R



(9D) D/C: 1016

Pack: R33
DEMY 031
B_R999_1011.1241_R

(G) GROUP: U5-1-0+V9-5-0+S7-6-0





OHA04614

Gurtverpackung
Tape and Reel

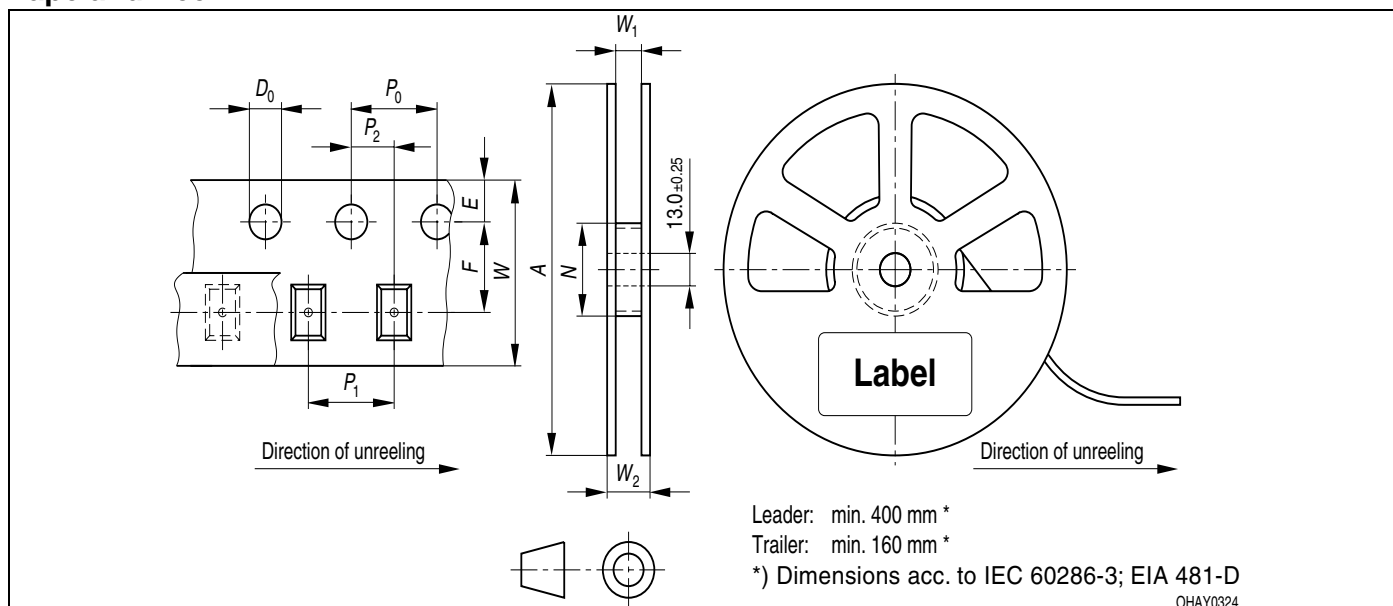

Tape dimensions in mm (inch)

W	P ₀	P ₁	P ₂	D ₀	E	F
12 ^{+0.3} _{-0.1}	4 ± 0.1 (0.157 ± 0.004)	8 ± 0.1 (0.315 ± 0.004)	2 ± 0.05 (0.079 ± 0.002)	1.5 + 0.1 (0.059 + 0.004)	1.75 ± 0.1 (0.069 ± 0.004)	5.5 ± 0.05 (0.217 ± 0.002)

Reel dimensions in mm (inch)

A	W	N _{min}	W ₁	W _{2 max}
180 (7)	12 (0.472)	60 (2.362)	12.4 + 2 (0.488 + 0.079)	18.4 (0.724)

Trockenverpackung und Materialien Dry Packing Process and Materials

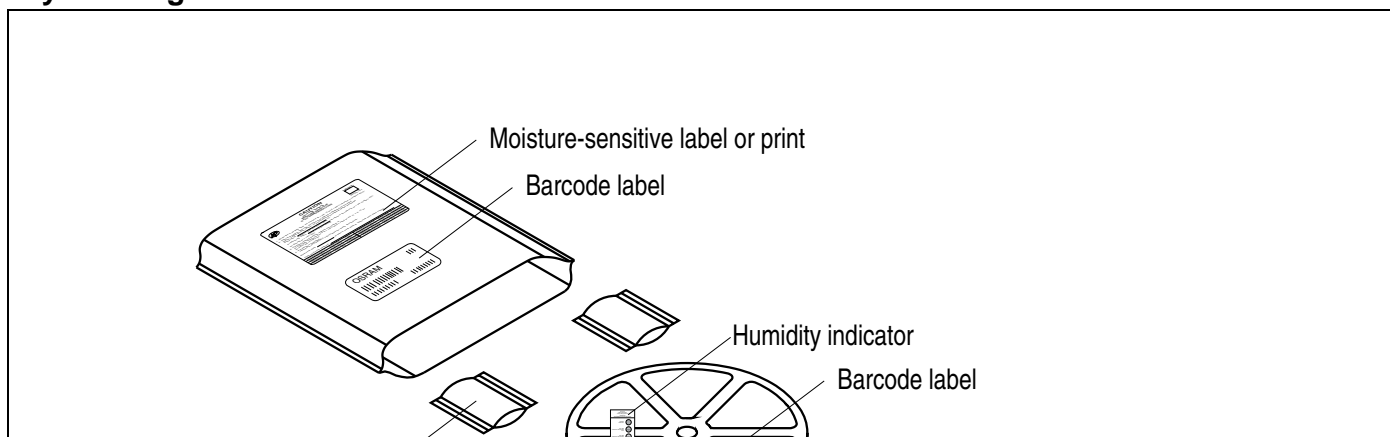

Anm.: Feuchteempfindliche Produkte sind verpackt in einem Trockenbeutel zusammen mit einem Trockenmittel und einer Feuchteindikatorkarte

Bezüglich Trockenverpackung finden Sie weitere Hinweise im Internet und in unserem Short Form Catalog im Kapitel "Gurtung und Verpackung" unter dem Punkt "Trockenverpackung". Hier sind Normenbezüge, unter anderem ein Auszug der JEDEC-Norm, enthalten.

Note: Moisture-sensitive product is packed in a dry bag containing desiccant and a humidity card.

Regarding dry pack you will find further information in the internet and in the Short Form Catalog in chapter "Tape and Reel" under the topic "Dry Pack". Here you will also find the normative references like JEDEC.

Kartonverpackung und Materialien Transportation Packing and Materials

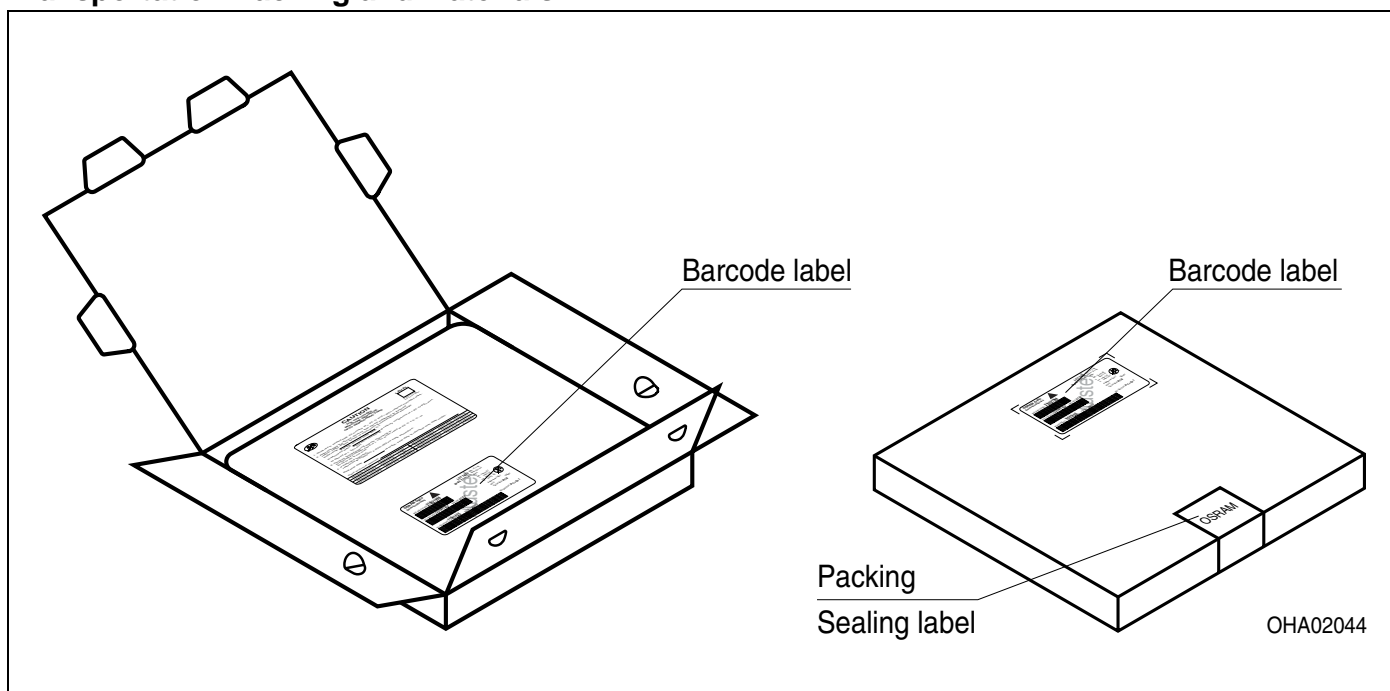

Dimensions of transportation box in mm (inch)

Breite / Width	Länge / length	Höhe / height
200 ±5 (7,874 ±0,1968±)	200 ±5 (7,874 ±0,1968)	30 ±5 (1,1811 ±0,1968)

Revision History: 2014-01-28

Previous Version: 2010-12-02

Page	Subjects (major changes since last revision)	Date of change
all	Preliminary Data Sheet	2009-07-28
2, 6, 7, 8	ordering code changed	2009-10-14
4, 8	Dominant wavelength: Color blue: groups 8 and 9 removed	2009-10-14
5, 6	Chromaticity Coordinate Groups: Color blue: groups 8 and 9 removed	2009-10-14
2, 6, 7, 8	ordering code changed	2010-02-26
4, 8	Dominant wavelength: Color blue: groups 8 and 9 added	2010-02-26
5, 6	Chromaticity Coordinate Groups: Color blue: groups 8 and 9 added	2010-02-26
23	OS-IN-2010-032	2010-10-04
all	Final datasheet created	2010-12-02
19	Package Outlines updated	
1	Application recommendation adapted	2014-01-28

Attention please!

The information describes the type of component and shall not be considered as assured characteristics.

Terms of delivery and rights to change design reserved. Due to technical requirements components may contain dangerous substances. For information on the types in question please contact our Sales Organization.

If printed or downloaded, please find the latest version in the Internet.

Packing

Please use the recycling operators known to you. We can also help you – get in touch with your nearest sales office. By agreement we will take packing material back, if it is sorted. You must bear the costs of transport. For packing material that is returned to us unsorted or which we are not obliged to accept, we shall have to invoice you for any costs incurred.

Components used in life-support devices or systems must be expressly authorized for such purpose! Critical components^{8) page 25} may only be used in life-support devices or systems^{9) page 25} with the express written approval of OSRAM OS.

Fußnoten:

- 1) Helligkeitswerte werden während eines Strompulses einer typischen Dauer von 25 ms, mit einer internen Reproduzierbarkeit von +/- 8 % und einer erweiterten Messunsicherheit von +/- 11 % gemessen (gemäß GUM mit Erweiterungsfaktor $k = 3$).
- 2) Die LED kann kurzzeitig in Sperrichtung betrieben werden.
- 3) Die dominante Wellenlänge wird während eines Strompulses einer typischen Dauer von 25 ms, mit einer internen Reproduzierbarkeit von +/- 0,5 nm und einer erweiterten Messunsicherheit von +/- 1 nm gemessen (gemäß GUM mit Erweiterungsfaktor $k = 3$).
- 4) Vorwärtsspannungen werden während eines Strompulses einer typischen Dauer von 8 ms, mit einer internen Reproduzierbarkeit von +/- 0,05 V und einer erweiterten Messunsicherheit von +/- 0,1 V gemessen (gemäß GUM mit Erweiterungsfaktor $k=3$).
- 5) Wegen der besonderen Prozessbedingungen bei der Herstellung von LED können typische oder abgeleitete technische Parameter nur aufgrund statistischer Werte wiedergegeben werden. Diese stimmen nicht notwendigerweise mit den Werten jedes einzelnen Produktes überein, dessen Werte sich von typischen und abgeleiteten Werten oder typischen Kennlinien unterscheiden können. Falls erforderlich, z.B. aufgrund technischer Verbesserungen, werden diese typischen Werte ohne weitere Ankündigung geändert.
- 6) Maße werden wie folgt angegeben: mm (inch)
- 7) Gehäuse hält TTW-Löthitze aus nach CECC 00802
- 8) Ein kritisches Bauteil ist ein Bauteil, das in lebenserhaltenden Apparaten oder Systemen eingesetzt wird und dessen Defekt voraussichtlich zu einer Fehlfunktion dieses lebenserhaltenden Apparates oder Systems führen wird oder die Sicherheit oder Effektivität dieses Apparates oder Systems beeinträchtigt.
- 9) Lebenserhaltende Apparate oder Systeme sind für
 - (a) die Implantierung in den menschlichen Körper oder
 - (b) für die Lebenserhaltung bestimmt.
 Falls sie versagen, kann davon ausgegangen werden, dass die Gesundheit und das Leben des Patienten in Gefahr ist.

Remarks:

- 1) Brightness values are measured during a current pulse of typical 25 ms, with an internal reproducibility of +/- 8 % and an expanded uncertainty of +/- 11 % (acc. to GUM with a coverage factor of $k = 3$).
- 2) Driving the LED in reverse direction is suitable for short term application.
- 3) The dominant wavelength is measured at a current pulse of typical 25 ms, with an internal reproducibility of +/- 0,5 nm and an expanded uncertainty of +/- 1 nm (acc. to GUM with a coverage factor of $k=3$).
- 4) The forward voltage is measured during a current pulse of typical 8 ms, with an internal reproducibility of +/- 0,05 V and an expanded uncertainty of +/- 0,1 V (acc. to GUM with a coverage factor of $k=3$).
- 5) Due to the special conditions of the manufacturing processes of LED, the typical data or calculated correlations of technical parameters can only reflect statistical figures. These do not necessarily correspond to the actual parameters of each single product, which could differ from the typical data and calculated correlations or the typical characteristic line. If requested, e.g. because of technical improvements, these typ. data will be changed without any further notice.
- 6) Dimensions are specified as follows: mm (inch)
- 7) Package able to withstand TTW-soldering heat acc. to CECC 00802
- 8) A critical component is a component used in a life-support device or system whose failure can reasonably be expected to cause the failure of that life-support device or system, or to affect its safety or the effectiveness of that device or system.
- 9) Life support devices or systems are intended
 - (a) to be implanted in the human body,
 - or
 - (b) to support and/or maintain and sustain human life. If they fail, it is reasonable to assume that the health and the life of the user may be endangered.

