

EDGE NOTCHING FOR 10 ROW ASSEMBLIES (10 POSITION SHOWN)

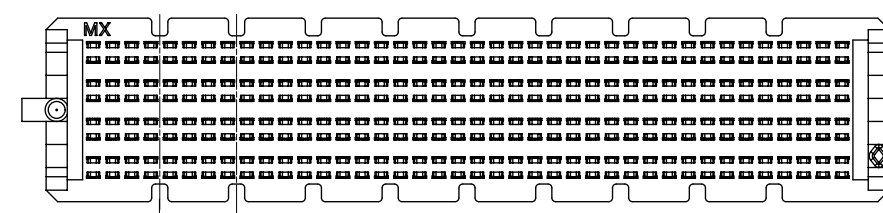

EDGE NOTCHING FOR 8 ROW 40 POSITION ASSEMBLIES

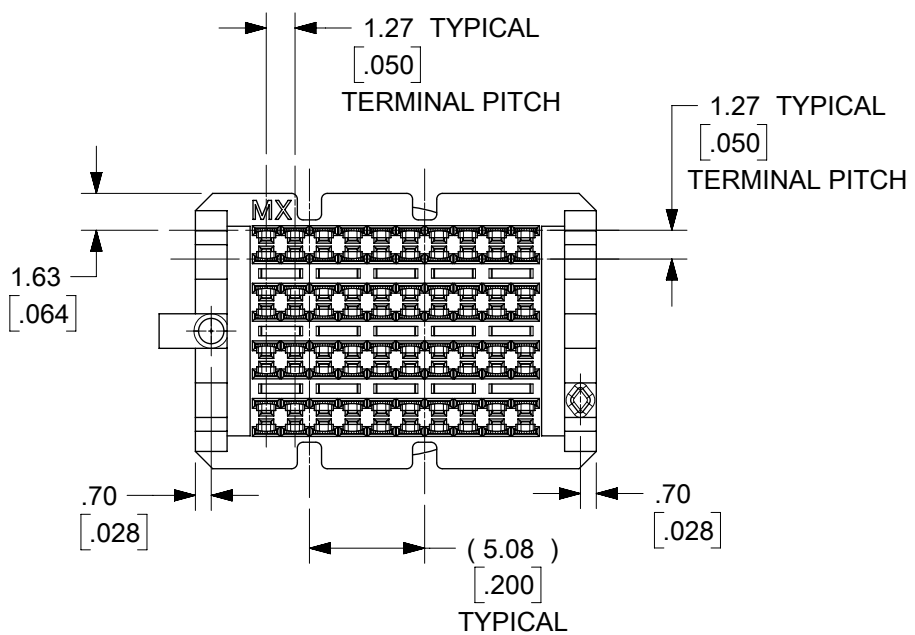

SEE OTHER EDGE NOTCHING VIEWS
SEE SHEET 2 FOR 6 ROW OPTION

- NOTES:
- MATERIAL: HOUSING: GLASS FILLED LCP (LIQUID CRYSTAL POLYMER), UL94V-0, BLACK
CONTACTS: COPPER ALLOY
SOLDER CHARGE: 95.5% TIN, 3.8% SILVER, 0.7% COPPER
 - FINISH: ALL DIM P HEIGHT OPTIONS: SELECT GOLD IN CONTACT AREA, 30 MICROINCH MINIMUM
DIM P HEIGHT OPTIONS 2.0 & 2.5: SELECT GOLD FLASH ON TAIL, 7 MICROINCH MINIMUM
DIM P HEIGHT OPTIONS 3.0 THRU 9.0: SELECT TIN ON TAIL, 50 MICROINCH MINIMUM
ALL OPTIONS - NICKEL UNDERPLATE OVERALL ON TAIL
 - PRODUCT SPECIFICATION: PS-45970-001
 - PACKAGING SPECIFICATION: PK-45970-002 (TAPE AND REEL)
 - MATES WITH SEARAY RECEPTACLE ASSEMBLY SERIES 45971
 - APPLICATION SPECIFICATION: AS-45970-001
 - COSMETIC SPECIFICATION: PS-45499-002 CLASS B
 - PART STATUS: CONTACT MOLEX

POSITIONS	TOTAL NUMBER OF EDGE NOTCHES			Symbol
	8 ROW	6 ROW	10 ROW	
10	4	4	4	0.15/.006
15	6	6	6	
20	10	10	10	
25	12	12	12	
30	14	14	14	
35	16	16	16	
40	18	20	20	0.23/.009
*40	-	-	*24	
45	22	22	22	
50	24	24	24	
**50	-	-	**28	

*FOR 45970-4916
**FOR 45970-5916

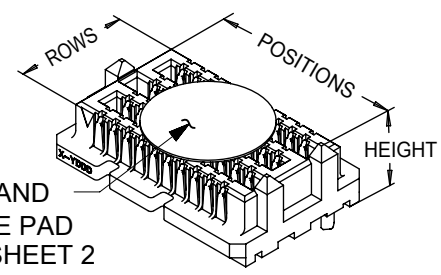

SEE TABLE ON SHEET 6 FOR HOUSING OPTIONS

THIS DRAWING CONTAINS INFORMATION THAT IS PROPRIETARY TO MOLEX ELECTRONIC TECHNOLOGIES, LLC AND SHOULD NOT BE USED WITHOUT WRITTEN PERMISSION

DIMENSION UNITS	SCALE	CURRENT REV DESC:		molex		
mm	NTS					
GENERAL TOLERANCES (UNLESS SPECIFIED)		EC NO: 712067		SEARAY PLUG ASSEMBLY 1.27/.050 CENTERS		
ANGULAR TOL ± °		DRWN: CLHOE01 2022/01/10				
4 PLACES ±		CHK'D: HCGOH 2022/06/27		PRODUCT CUSTOMER DRAWING		
3 PLACES ±		APPR: SHONG 2022/07/14				
2 PLACES ± 0.25		INITIAL REVISION:		DOCUMENT NUMBER		
1 PLACE ± 0.38		DRWN: TGREGORI 2006/01/25				
0 PLACES ±		APPR: JCOMERCI 2006/01/30		SD-45970-001		
DRAFT WHERE APPLICABLE MUST REMAIN WITHIN DIMENSIONS		THIRD ANGLE PROJECTION				
		DRAWING		PSD 001 V		
		SERIES				
		B-SIZE 45970		SEE TABLE GENERAL MARKET 1 OF 6		

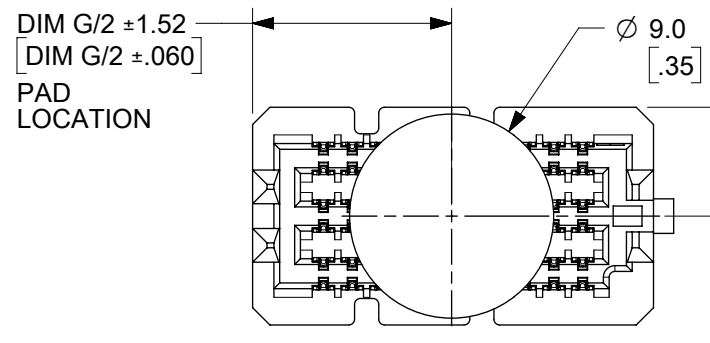

6 ROW OPTION

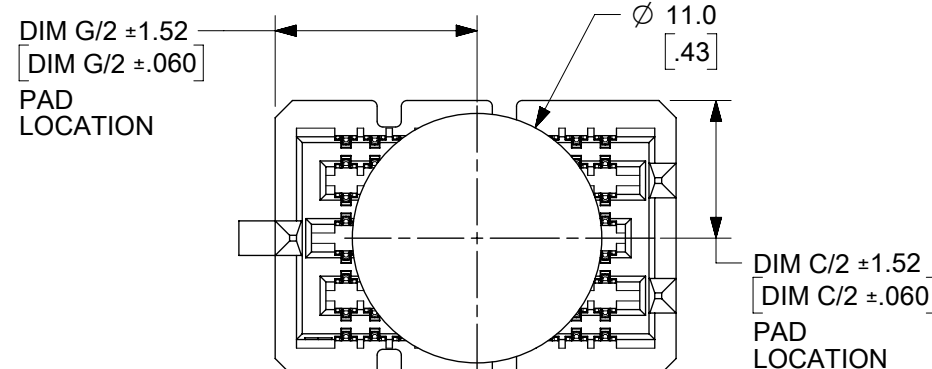

8 ROW OPTION

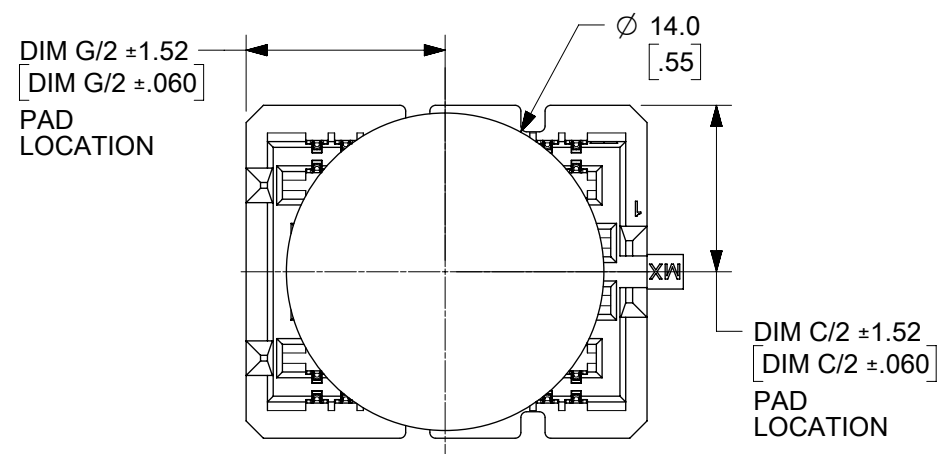

10 ROW OPTION

PICK AND PLACE
PAD DIAMETERS
10 POSITION VERSIONS SHOWN

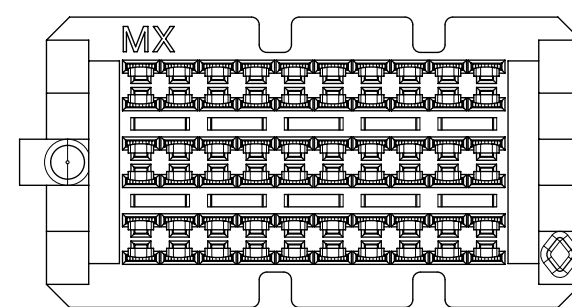
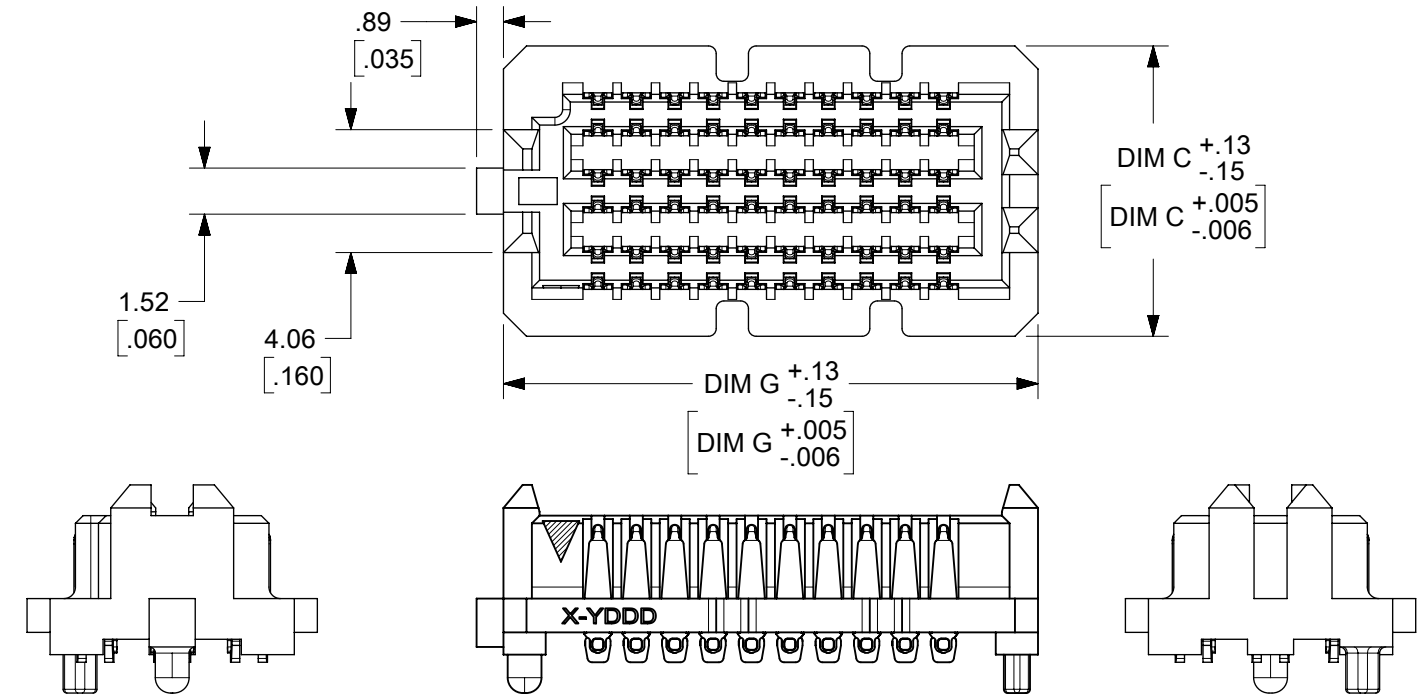

6 ROW OPTION

10 POSITION VERSION
SHOWN FOR REFERENCE

DIMENSIONS SHOWN ON
OTHER SHEETS APPLY TO
THE 6 ROW OPTION ALSO
(EXCEPT AS OTHERWISE
NOTED ON THIS SHEET)

THIS DRAWING CONTAINS INFORMATION THAT IS PROPRIETARY TO MOLEX ELECTRONIC TECHNOLOGIES, LLC AND SHOULD NOT BE USED WITHOUT WRITTEN PERMISSION											
DIMENSION UNITS		SCALE		CURRENT REV DESC:						molex	
mm		NTS									
GENERAL TOLERANCES (UNLESS SPECIFIED)				EC NO: 712067						SEARAY	
ANGULAR TOL ± °				DRWN: CLHOE01 2022/01/10						PLUG ASSEMBLY 1.27/.050 CENTERS	
4 PLACES ±				CHK'D: HCGOH 2022/06/27						PRODUCT CUSTOMER DRAWING	
3 PLACES ±				APPR: SHONG 2022/07/14						DOCUMENT NUMBER	
2 PLACES ± 0.25				INITIAL REVISION:						SD-45970-001	
1 PLACE ± 0.38				DRWN: TGREGORI 2006/01/25						DOC TYPE	
0 PLACES ±				APPR: JCOMERCI 2006/01/30						DOC PART	
DRAFT WHERE APPLICABLE MUST REMAIN WITHIN DIMENSIONS				THIRD ANGLE PROJECTION		DRAWING		SERIES		REVISION	
				B-SIZE		45970		MATERIAL NUMBER		SEE TABLE	
				GENERAL MARKET		CUSTOMER		SHEET NUMBER		2 OF 6	

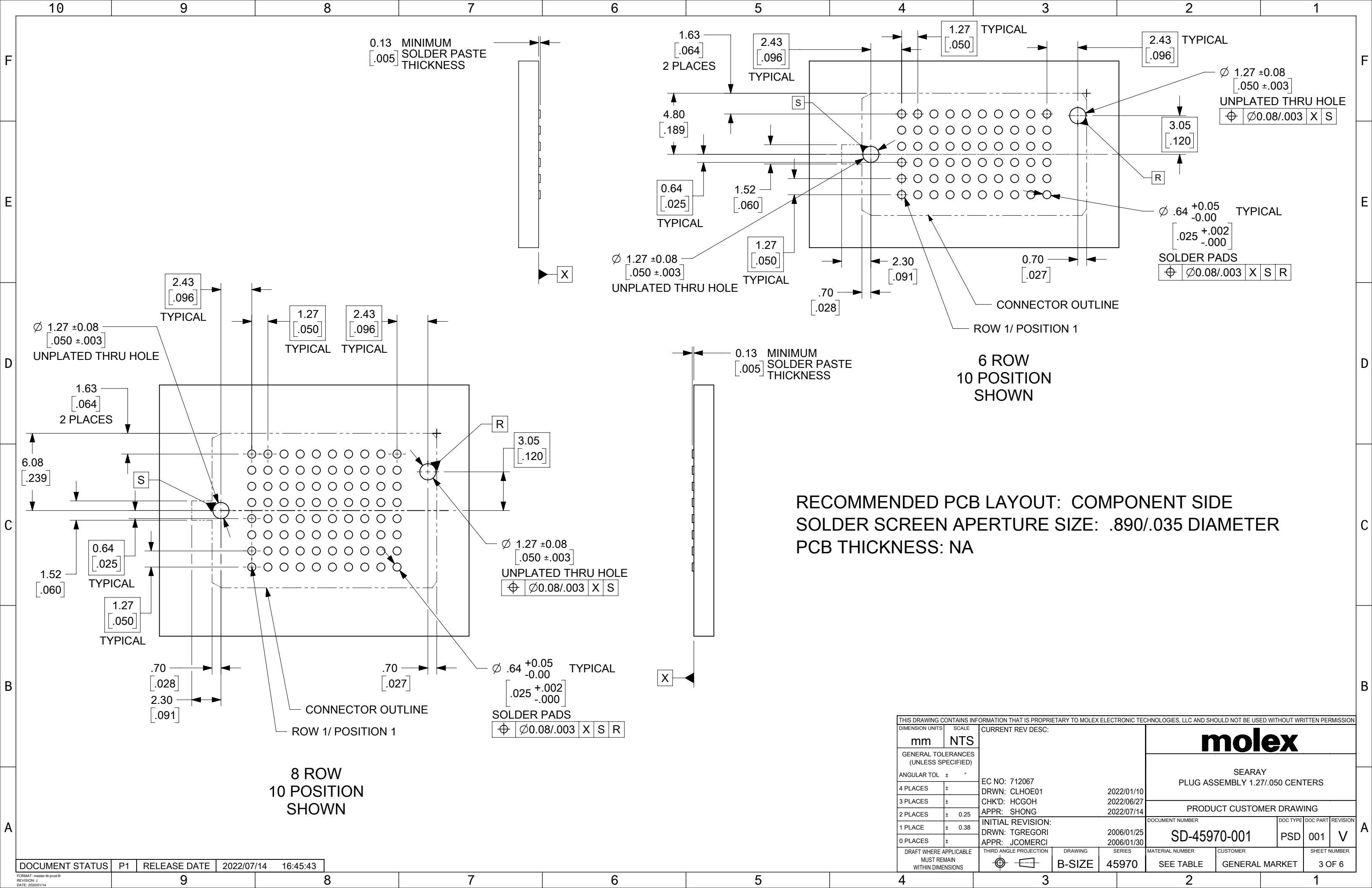

THIS DRAWING CONTAINS INFORMATION THAT IS PROPRIETARY TO MOLEX ELECTRONIC TECHNOLOGIES, LLC AND SHOULD NOT BE USED WITHOUT WRITTEN PERMISSION											
DIMENSION UNITS: mm		SCALE: NTS		CURRENT REV DESC:				molex		SEARAY PLUG ASSEMBLY 1.27/.050 CENTERS	
GENERAL TOLERANCES (UNLESS SPECIFIED)		ANGULAR TOL ± °		EC NO: 712067 DRWN: CLHOE01 2022/01/10 CHK'D: HCGOH 2022/06/27 APPR: SHONG 2022/07/14							
4 PLACES ±		3 PLACES ±		2 PLACES ± 0.25		1 PLACE ± 0.38		PRODUCT CUSTOMER DRAWING		DOCUMENT NUMBER	
0 PLACES ±		DRAFT WHERE APPLICABLE MUST REMAIN WITHIN DIMENSIONS		THIRD ANGLE PROJECTION		DRAWING: B-SIZE		SERIES: 45970		MATERIAL NUMBER: SEE TABLE	
CUSTOMER: GENERAL MARKET		REVISION: V		SHEET NUMBER: 3 OF 6		CUSTOMER: GENERAL MARKET		DOCUMENT NUMBER: SD-45970-001		DOC TYPE: PSD	

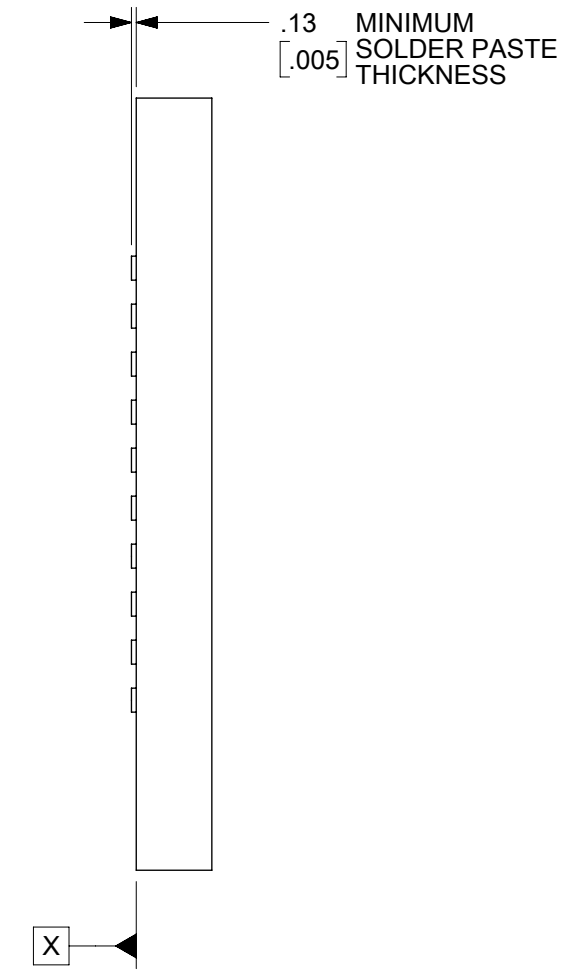
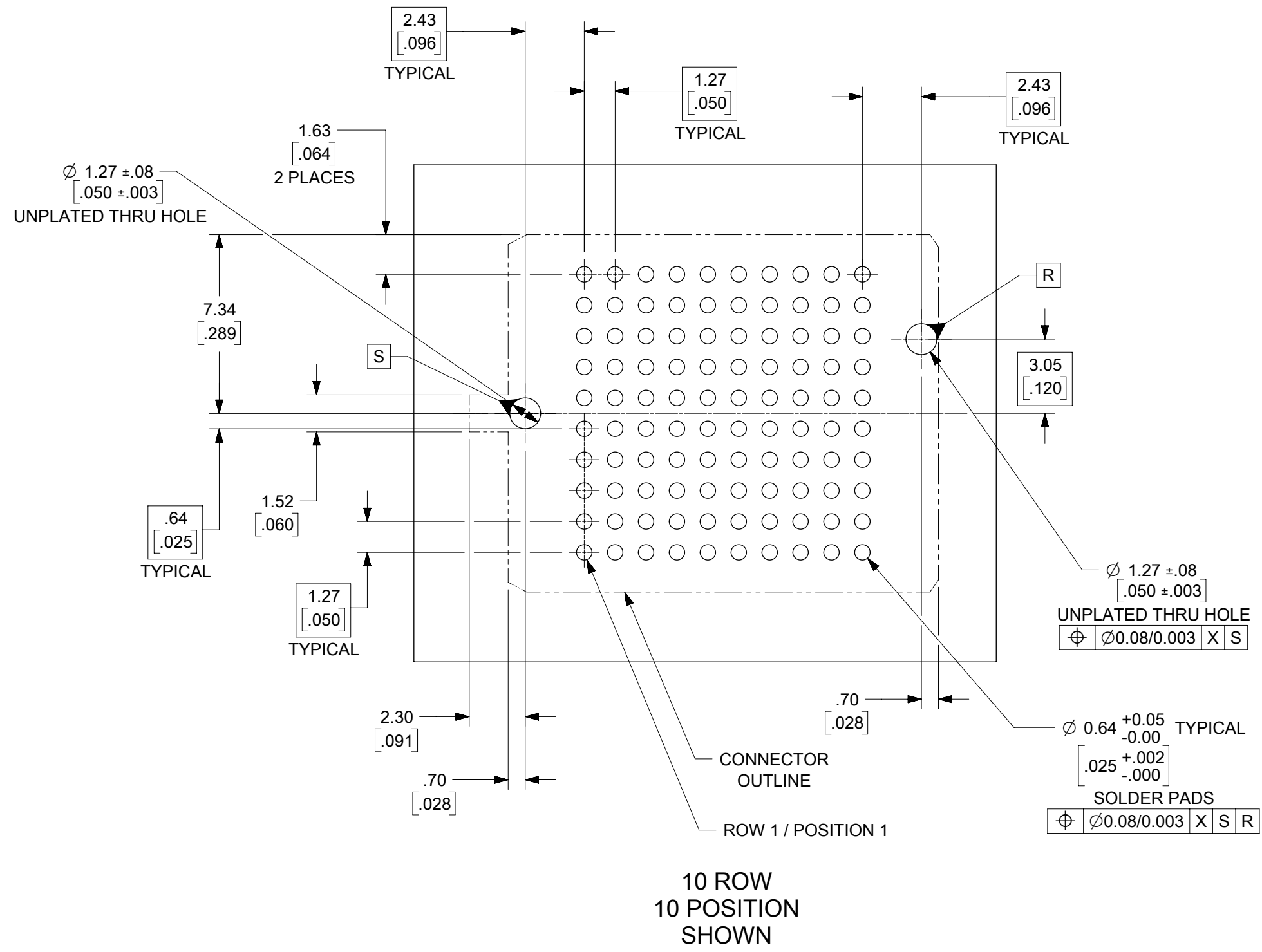

10 ROW
10 POSITION
SHOWN

RECOMMENDED PCB LAYOUT: COMPONENT SIDE
 SOLDER SCREEN APERTURE SIZE: .890/.035 DIAMETER
 PCB THICKNESS: NA

THIS DRAWING CONTAINS INFORMATION THAT IS PROPRIETARY TO MOLEX ELECTRONIC TECHNOLOGIES, LLC AND SHOULD NOT BE USED WITHOUT WRITTEN PERMISSION									
DIMENSION UNITS	SCALE	CURRENT REV DESC:							
mm	NTS								
GENERAL TOLERANCES (UNLESS SPECIFIED)		EC NO: 712067			SEARAY				
ANGULAR TOL ± °		DRWN: CLHOE01			PLUG ASSEMBLY 1.27/.050 CENTERS				
4 PLACES ±		CHK'D: HCGOH			PRODUCT CUSTOMER DRAWING				
3 PLACES ±		APPR: SHONG			DOCUMENT NUMBER				
2 PLACES ± 0.25		INITIAL REVISION:			SD-45970-001				
1 PLACE ± 0.38		DRWN: TREGORI			DOC TYPE DOC PART REVISION				
0 PLACES ±		APPR: JCOMERCI			PSD 001 V				
DRAFT WHERE APPLICABLE MUST REMAIN WITHIN DIMENSIONS		THIRD ANGLE PROJECTION	DRAWING	SERIES	MATERIAL NUMBER	CUSTOMER	SHEET NUMBER		
			B-SIZE	45970	SEE TABLE	GENERAL MARKET	4 OF 6		

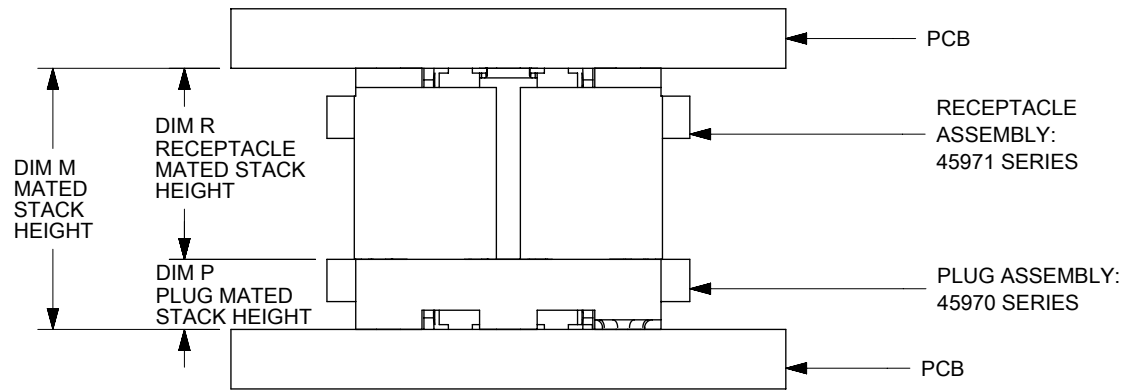

STACK HEIGHTS
GIVEN IN MILLIMETERS (MM) FOR REFERENCE ONLY

ROWS: 6 DIMENSION C = 9.60/.378		
DIM P:	2.0 mm	
DIM H:	5.61/.221	
DIM S:	5.86/.231	
POSITION	DIM G	MATERIAL NO
30	43.09/1.698	45970-3165

MATING STACK HEIGHTS (DIMENSION P)
GIVEN IN MILLIMETERS (mm) FOR REFERENCE ONLY

mm	DIM R RECEPTACLE STACK HEIGHT									
	5.0		6.0		6.5		7.5		8.0	
	DIM M FULLY MATED	DIM M MAX	DIM M FULLY MATED	DIM M MAX	DIM M FULLY MATED	DIM M MAX	DIM M FULLY MATED	DIM M MAX	DIM M FULLY MATED	DIM M MAX
2.0	7.00	7.74	8.00	8.74	8.50	9.24	9.50	10.24	10.00	10.74
2.5	7.50	8.24	8.50	9.24	9.00	9.74	10.00	10.74	10.50	11.24
3.0	8.00	8.74	9.00	9.74	9.50	10.24	10.50	11.24	11.00	11.74
3.5	8.50	9.24	9.50	10.24	10.00	10.74	11.00	11.74	11.50	12.24
4.5	9.50	10.24	10.50	11.24	11.00	11.74	12.00	12.74	12.50	13.24
5.0	10.00	10.74	11.00	11.74	11.50	12.24	12.50	13.24	13.00	13.74
7.0	12.00	12.74	13.00	13.74	13.50	14.24	14.50	15.24	15.00	15.74
9.0	14.00	14.74	15.00	15.74	15.50	16.24	16.50	17.24	17.00	17.74

MATED STACK HEIGHTS
GIVEN IN MILLIMETERS (mm) FOR REFERENCE ONLY

THIS DRAWING CONTAINS INFORMATION THAT IS PROPRIETARY TO MOLEX ELECTRONIC TECHNOLOGIES, LLC AND SHOULD NOT BE USED WITHOUT WRITTEN PERMISSION									
DIMENSION UNITS	SCALE	CURRENT REV DESC:				molex			
mm	NTS								
GENERAL TOLERANCES (UNLESS SPECIFIED)		EC NO: 712067				SEARAY PLUG ASSEMBLY 1.27/.050 CENTERS			
ANGULAR TOL ± °		DRWN: CLHOE01 2022/01/10							
4 PLACES ±		CHK'D: HCGOH 2022/06/27				PRODUCT CUSTOMER DRAWING			
3 PLACES ±		APPR: SHONG 2022/07/14							
2 PLACES ± 0.25		INITIAL REVISION:				DOCUMENT NUMBER			
1 PLACE ± 0.38		DRWN: TGREGORI 2006/01/25							
0 PLACES ±		APPR: JCOMERCI 2006/01/30				SD-45970-001			
DRAFT WHERE APPLICABLE MUST REMAIN WITHIN DIMENSIONS		THIRD ANGLE PROJECTION	DRAWING	SERIES	MATERIAL NUMBER	CUSTOMER	DOC TYPE	DOC PART	REVISION
			B-SIZE	45970	SEE TABLE	GENERAL MARKET	PSD	001	V
									SHEET NUMBER
									5 OF 6

ROWS: 8 DIMENSION C = 12.14/.478			
DIM P:		2.0 mm	3.5 mm
DIM H:		5.61/.221	7.11/.280
DIM S:		5.86/.231	7.36/.290
POSITION	DIM G	MATERIAL NO	MATERIAL NO
20	30.39/1.198	45970-2185	45970-2385
30	43.09/1.698	45970-3185	45970-3385
40	55.79/2.198	45970-4185	45970-4385
50	68.49/2.698	45970-5185	

ROWS: 10 DIMENSION C = 14.68/.578										
DIM P:		2.0 mm	3.0 mm	3.5 mm	2.5 mm	4.5 mm	5.0 mm	7.0 mm	9.0 mm	9.0 mm
DIM H:		5.61/.221	6.60/.260	7.11/.280	6.12/.241	8.10/.319	8.61/.339	10.61/.418	12.62/.497	12.62/.497
DIM S:		5.86/.231	6.85/.270	7.36/.290	6.37/.251	8.35/.329	8.86/.349	10.86/.428	12.87/.507	12.87/.507
POSITION	DIM G	MATERIAL NO	MATERIAL NO	MATERIAL NO	MATERIAL NO	MATERIAL NO	MATERIAL NO	MATERIAL NO	MATERIAL NO	MATERIAL NO
10	17.69/0.698	45970-1115	45970-1215	45970-1315	45970-1415	45970-1515	45970-1615	45970-1715	45970-1915	
20	30.39/1.198	45970-2115	45970-2215	45970-2315	45970-2415	45970-2515	45970-2615	45970-2715	45970-2915	
30	43.09/1.698	45970-3115	45970-3215	45970-3315	45970-3415	45970-3515	45970-3615	45970-3715	45970-3915	
40	55.79/2.198	45970-4115	45970-4215	45970-4315	45970-4415	45970-4515	45970-4615	45970-4715		45970-4916
50	68.49/2.698	45970-5115	45970-5215	45970-5315	45970-5415	45970-5515	45970-5615	45970-5715		45970-5916
15	24.04/0.948	45970-6115	45970-6215	45970-6315	45970-6415	45970-6515	45970-6615	45970-6715	45970-6915	
25	36.74/1.448	45970-7115	45970-7215	45970-7315	45970-7415	45970-7515	45970-7615	45970-7715	45970-7915	
35	49.44/1.948	45970-8115	45970-8215	45970-8315	45970-8415	45970-8515	45970-8615	45970-8715	45970-8915	
45	62.14/2.448	45970-9115	45970-9215	45970-9315	45970-9415	45970-9515	45970-9615	45970-9715	45970-9915	

MATING STACK HEIGHTS (DIMENSION P)
GIVEN IN MILLIMETERS (mm) FOR REFERENCE ONLY

9.0mm PLUG WITH ALIGNER
45970-4916 SHOWN

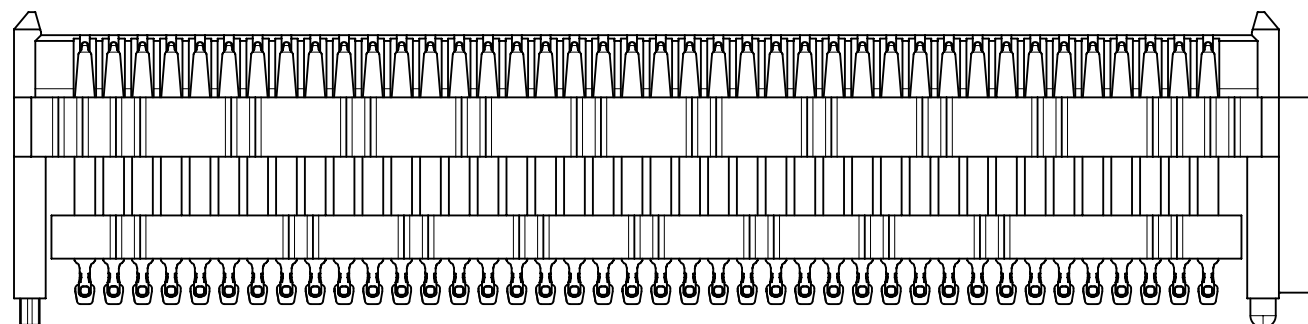

THIS DRAWING CONTAINS INFORMATION THAT IS PROPRIETARY TO MOLEX ELECTRONIC TECHNOLOGIES, LLC AND SHOULD NOT BE USED WITHOUT WRITTEN PERMISSION												
DIMENSION UNITS		SCALE		CURRENT REV DESC:							molex	
mm		NTS										
GENERAL TOLERANCES (UNLESS SPECIFIED)				EC NO: 712067							2022/01/10	
ANGULAR TOL ± °				DRWN: CLHOE01							2022/06/27	
4 PLACES ±				CHK'D: HCGOH							2022/07/14	
3 PLACES ±				APPR: SHONG								
2 PLACES ± 0.25				INITIAL REVISION:							DOCUMENT NUMBER	
1 PLACE ± 0.38				DRWN: TGREGORI							SD-45970-001	
0 PLACES ±				APPR: JCOMERCI							DOC TYPE DOC PART REVISION	
DRAFT WHERE APPLICABLE MUST REMAIN WITHIN DIMENSIONS				THIRD ANGLE PROJECTION		DRAWING		SERIES		MATERIAL NUMBER		
				B-SIZE		45970		CUSTOMER		SEE TABLE		
								GENERAL MARKET		SHEET NUMBER		
										6 OF 6		