

74ACTQ843 Quiet Series™ 9-Bit Transparent Latch with 3-STATE Outputs

General Description

The ACTQ843 bus interface latch is designed to eliminate the extra packages required to buffer existing latches and provide extra data width for wider address/data paths. The ACTQ843 utilizes Fairchild FACT Quiet Series™ technology to guarantee quiet output switching and improved dynamic threshold performance. FACT Quiet Series features GTO™ output control and undershoot corrector in addition to a split ground bus for superior performance.

Features

- Guaranteed simultaneous switching noise level and dynamic threshold performance
- Guaranteed pin-to-pin skew AC performance
- Inputs and outputs on opposite sides of package for easy interface with microprocessors
- Improved latch-up immunity
- Outputs source/sink 24 mA
- 3-STATE outputs for bus interfacing
- TTL compatible inputs

Ordering Code:

Order Number	Package Number	Package Description
74ACTQ843SC	M24B	24-Lead Small Outline Integrated Circuit (SOIC), JEDEC MS-013, 0.300 Wide
74ACTQ843SPC	N24C	24-Lead Plastic Dual-In-Line Package (PDIP), JEDEC MS-001, 0.300 Wide

Device also available in Tape and Reel. Specify by appending suffix letter "X" to the ordering code.

Logic Symbols

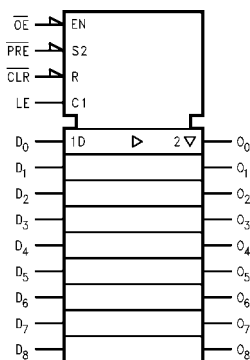
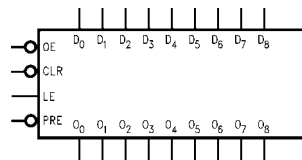

Connection Diagram

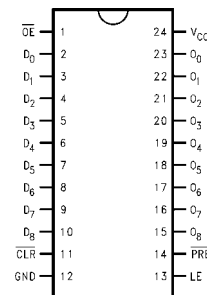

Pin Descriptions

Pin Names	Description
D ₀ -D ₈	Data Inputs
O ₀ -O ₈	Data Outputs
\overline{OE}	Output Enable
LE	Latch Enable
\overline{CLR}	Clear
PRE	Preset

FACT™, Quiet Series™, FACT Quiet Series™ and GTO™ are trademarks of Fairchild Semiconductor Corporation.

Functional Description

The ACTQ843 consists of nine D-type latches with 3-STATE outputs. The flip-flops appear transparent to the data when Latch Enable (LE) is HIGH. This allows asynchronous operation, as the output transition follows the data in transition. On the LE HIGH-to-LOW transition, the data that meets the setup times is latched. Data appears on the bus when the Output Enable (\overline{OE}) is LOW. When \overline{OE} is HIGH, the bus output is in the high impedance state. In addition to the LE and \overline{OE} pins, the ACTQ843 has a Clear (\overline{CLR}) pin and a Preset (\overline{PRE}) pin. These pins are ideal for parity bus interfacing in high performance systems. When \overline{CLR} is LOW, the outputs are LOW if \overline{OE} is LOW. When \overline{CLR} is HIGH, data can be entered into the latch. When \overline{PRE} is LOW, the outputs are HIGH if \overline{OE} is LOW. Preset overrides CLR.

Function Table

Inputs					Internal	Outputs	Function
\overline{CLR}	\overline{PRE}	\overline{OE}	LE	D	Q	O	
H	H	H	H	L	L	Z	High Z
H	H	H	H	H	H	Z	High Z
H	H	H	L	X	NC	Z	Latched
H	H	L	H	L	L	L	Transparent
H	H	L	H	H	H	H	Transparent
H	H	L	L	X	NC	NC	Latched
H	L	L	X	X	H	H	Preset
L	H	L	X	X	L	L	Clear
L	L	L	X	X	H	H	Preset
L	H	H	L	X	L	Z	Clear/High Z
H	L	H	L	X	H	Z	Preset/High Z

H = HIGH Voltage Level
 L = LOW Voltage Level
 X = Immaterial
 Z = High Impedance
 NC = No Change

Logic Diagram

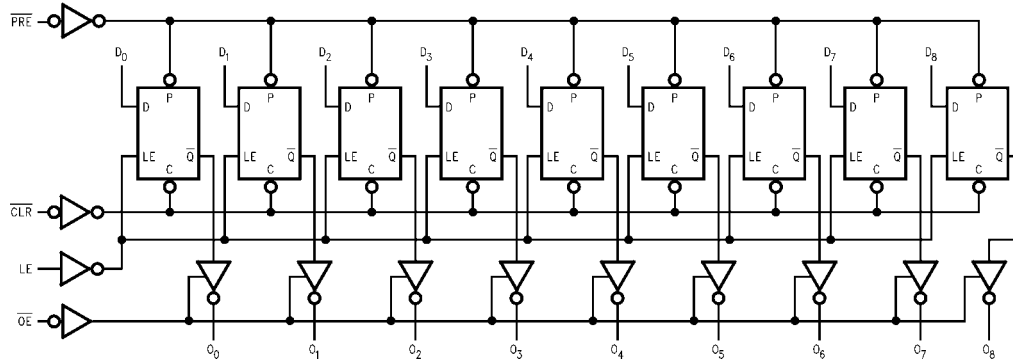

Absolute Maximum Ratings(Note 1)

Supply Voltage (V_{CC})	-0.5V to +7.0V
DC Input Diode Current (I_{IK})	
$V_I = -0.5V$	-20 mA
$V_I = V_{CC} + 0.5V$	+20 mA
DC Input Voltage (V_I)	-0.5V to $V_{CC} + 0.5V$
DC Output Diode Current (I_{OK})	
$V_O = -0.5V$	-20 mA
$V_O = V_{CC} + 0.5V$	+20 mA
DC Output Voltage (V_O)	-0.5V to $V_{CC} + 0.5V$
DC Output Source or Sink Current (I_O)	± 50 mA
DC V_{CC} or Ground Current per Output Pin (I_{CC} or I_{GND})	± 50 mA
Storage Temperature (T_{STG})	-65°C to +150°C
DC Latch-Up Source or Sink Current	± 300 mA
Junction Temperature (T_J) PDIP	140°C

Recommended Operating Conditions

Supply Voltage (V_{CC})	4.5V to 5.5V
Input Voltage (V_I)	0V to V_{CC}
Output Voltage (V_O)	0V to V_{CC}
Operating Temperature (T_A)	-40°C to +85°C
Minimum Input Edge Rate $\Delta V/\Delta t$	125 mV/ns
V_{IN} from 0.8V to 2.0V	
V_{CC} @ 4.5V, 5.5V	

Note 1: Absolute maximum ratings are those values beyond which damage to the device may occur. The databook specifications should be met, without exception, to ensure that the system design is reliable over its power supply, temperature, and output/input loading variables. Fairchild does not recommend operation of FACT™ circuits outside databook specifications.

DC Electrical Characteristics

Symbol	Parameter	V_{CC} (V)	$T_A = +25^\circ\text{C}$		$T_A = -40^\circ\text{C to } +85^\circ\text{C}$		Units	Conditions
			Typ	Guaranteed Limits				
V_{IH}	Minimum HIGH Level Input Voltage	4.5	1.5	2.0	2.0	V	$V_{OUT} = 0.1V$ or $V_{CC} - 0.1V$	
		5.5	1.5	2.0	2.0			
V_{IL}	Maximum LOW Level Input Voltage	4.5	1.5	0.8	0.8	V	$V_{OUT} = 0.1V$ or $V_{CC} - 0.1V$	
		5.5	1.5	0.8	0.8			
V_{OH}	Minimum HIGH Level Output Voltage	4.5	4.49	4.4	4.4	V	$I_{OUT} = -50 \mu A$	
		5.5	5.49	5.4	5.4			
		4.5		3.86	3.76	V	$V_{IN} = V_{IL}$ or V_{IH} $I_{OH} = 24$ mA $I_{OH} = 24$ mA (Note 2)	
		5.5		4.86	4.76			
V_{OL}	Maximum LOW Level Output Voltage	4.5	0.001	0.1	0.1	V	$I_{OUT} = 50 \mu A$	
		5.5	0.001	0.1	0.1			
		4.5		0.36	0.44	V	$V_{IN} = V_{IL}$ or V_{IH} $I_{OL} = 24$ mA $I_{OL} = 24$ mA (Note 2)	
		5.5		0.36	0.44			
I_{IN}	Maximum Input Leakage Current	5.5		± 0.1	± 1.0	μA	$V_I = V_{CC}$, GND	
I_{OZ}	Maximum 3-STATE Leakage Current	5.5		± 0.5	± 5.0	μA	$V_I = V_{IL}$, V_{IH} $V_O = V_{CC}$, GND	
I_{CCT}	Maximum $I_{CC}/$ Input	5.5	0.6		1.5	mA	$V_I = V_{CC} - 2.1V$	
I_{OLD}	Minimum Dynamic	5.5			75	mA	$V_{OLD} = 1.65V$ Max	
I_{OHD}	Output Current (Note 3)	5.5			-75	mA	$V_{OHD} = 3.85V$ Min	
I_{CC}	Maximum Quiescent Supply Current	5.5		8.0	80.0	μA	$V_{IN} = V_{CC}$ or GND	
V_{OLP}	Quiet Output Maximum Dynamic V_{OL}	5.0	1.1	1.5		V	Figures 1, 2 (Note 4)(Note 5)	
V_{OLV}	Quiet Output Minimum Dynamic V_{OL}	5.0	-0.6	-1.2		V	Figures 1, 2 (Note 4)(Note 5)	
V_{IHD}	Minimum HIGH Level Dynamic Input Voltage	5.0	1.9	2.0		V	(Note 4)(Note 6)	

DC Electrical Characteristics (Continued)

Symbol	Parameter	V _{CC} (V)	T _A = +25°C		T _A = -40°C to +85°C		Units	Conditions
			Typ	Guaranteed Limits				
V _{ILD}	Maximum LOW Level Dynamic Input Voltage	5.0	1.2	0.8			V	(Note 4)(Note 6)

Note 2: All outputs loaded; thresholds on input associated with output under test.

Note 3: Maximum test duration 2.0 ms, one output loaded at a time.

Note 4: DIP package.

Note 5: Max number of outputs defined as (n). Data inputs are driven 0V to 3V. One output @ GND.

Note 6: Max number of data inputs (n) switching. (n - 1) inputs switching 0V to 3V. Input-under-test switching: 3V to threshold (V_{ILD}), 0V to threshold (V_{IHD}), f = 1 MHz.

AC Electrical Characteristics

Symbol	Parameter	V _{CC} (V) (Note 7)	T _A = +25°C C _L = 50 pF			T _A = -40°C to +85°C C _L = 50 pF		Units
			Min	Typ	Max	Min	Max	
t _{PLH}	Propagation Delay D _n to O _n	5.0	2.5	6.2	9.5	2.0	10.0	ns
t _{PHL}	Propagation Delay D _n to O _n	5.0	2.5	6.7	9.5	2.0	10.0	ns
t _{PLH}	Propagation Delay LE to O _n	5.0	2.5	7.1	9.0	2.0	10.0	ns
t _{PHL}	Propagation Delay LE to O _n	5.0	2.5	6.9	9.0	2.0	10.0	ns
t _{PLH}	Propagation Delay PRE to O _n	5.0	2.5	7.3	10.0	2.0	11.0	ns
t _{PHL}	Propagation Delay CLR to O _n	5.0	2.5	7.2	11.0	2.0	12.0	ns
t _{PZH}	Output Enable Time OE to O _n	5.0	2.5	7.2	9.5	2.0	10.5	ns
t _{PZL}	Output Enable Time OE to O _n	5.0	2.5	7.5	9.5	2.0	10.5	ns
t _{PHZ}	Output Disable Time OE to O _n	5.0	1.5	5.0	8.0	1.0	8.5	ns
t _{PLZ}	Output Disable Time OE to O _n	5.0	1.5	5.1	8.0	1.0	8.5	ns
t _{PHL}	Propagation Delay PRE to O _n	5.0	2.5	6.7	10.0	2.0	11.0	ns
t _{PLH}	Propagation Delay CLR to O _n	5.0	2.5	7.3	11.0	2.0	12.0	ns
t _{OSLH}	Output to Output Skew (Note 8)	5.0		0.5	1.5		1.5	ns
t _{OSHL}	D _n to O _n							

Note 7: Voltage Range 5.0 is 5.0V ± 0.5V.

Note 8: Skew is defined as the absolute value of the difference between the actual propagation delay for any two outputs within the same packaged device. The specification applies to any outputs switching in the same direction, either HIGH-to-LOW (t_{OSHL}) or LOW-to-HIGH (t_{OSLH}). Parameter guaranteed by design. Not tested.

AC Operating Requirements

Symbol	Parameter	V _{CC} (V) (Note 9)	T _A = +25°C	T _A = -40°C to +85°C		Units
			C _L = 50 pF	C _L = 50 pF		
			Typ	Guaranteed Minimum		
t _S	Setup Time, HIGH or LOW D _n to LE	5.0		3.0	3.0	ns
t _H	Hold Time, HIGH or LOW D _n to LE	5.0		1.5	1.5	ns
t _W	LE Pulse Width, HIGH	5.0		4.0	4.0	ns
t _W	$\overline{\text{PRE}}$ Pulse Width, LOW	5.0		4.0	4.0	ns
t _W	$\overline{\text{CLR}}$ Pulse Width, LOW	5.0		4.0	4.0	ns
t _{REC}	$\overline{\text{PRE}}$ Recovery Time	5.0		2.0	2.0	ns
t _{rec}	$\overline{\text{CLR}}$ Recovery Time	5.0		2.0	2.0	ns

Note 9: Voltage Range 5.0 is 5.0V ± 0.5V.

Capacitance

Symbol	Parameter	Typ	Units	Conditions
C _{IN}	Input Capacitance	4.5	pF	V _{CC} = OPEN
C _{PD}	Power Dissipation Capacitance	52	pF	V _{CC} = 5.0V

FACT Noise Characteristics

The setup of a noise characteristics measurement is critical to the accuracy and repeatability of the tests. The following is a brief description of the setup used to measure the noise characteristics of FACT.

Equipment:

Hewlett Packard Model 8180A Word Generator
PC-163A Test Fixture
Tektronics Model 7854 Oscilloscope

Procedure:

1. Verify Test Fixture Loading: Standard Load 50 pF, 500Ω.
2. Deskew the HFS generator so that no two channels have greater than 150 ps skew between them. This requires that the oscilloscope be deskewed first. It is important to deskew the HFS generator channels before testing. This will ensure that the outputs switch simultaneously.
3. Terminate all inputs and outputs to ensure proper loading of the outputs and that the input levels are at the correct voltage.
4. Set the HFS generator to toggle all but one output at a frequency of 1 MHz. Greater frequencies will increase DUT heating and effect the results of the measurement.
5. Set the HFS generator input levels at 0V LOW and 3V HIGH for ACT devices and 0V LOW and 5V HIGH for AC devices. Verify levels with an oscilloscope.

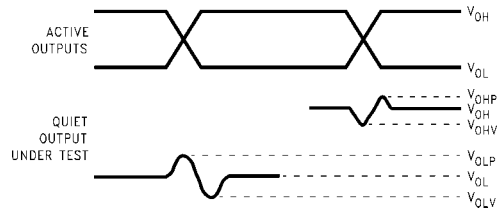

FIGURE 1. Quiet Output Noise Voltage Waveforms

Note 10: V_{OHV} and V_{OLP} are measured with respect to ground reference.

Note 11: Input pulses have the following characteristics: $f = 1$ MHz, $t_r = 3$ ns, $t_f = 3$ ns, skew < 150 ps.

V_{OLP}/V_{OLV} and V_{OHP}/V_{OHV} :

- Determine the quiet output pin that demonstrates the greatest noise levels. The worst case pin will usually be the furthest from the ground pin. Monitor the output voltages using a 50Ω coaxial cable plugged into a standard SMB type connector on the test fixture. Do not use an active FET probe.
- Measure V_{OLP} and V_{OLV} on the quiet output during the worst case transition for active and enable. Measure V_{OHP} and V_{OHV} on the quiet output during the worst case active and enable transition.
- Verify that the GND reference recorded on the oscilloscope has not drifted to ensure the accuracy and repeatability of the measurements.

V_{ILD} and V_{IHD} :

- Monitor one of the switching outputs using a 50Ω coaxial cable plugged into a standard SMB type connector on the test fixture. Do not use an active FET probe.
- First increase the input LOW voltage level, V_{IL} , until the output begins to oscillate or steps out a min of 2 ns. Oscillation is defined as noise on the output LOW level that exceeds V_{IL} limits, or on output HIGH levels that exceed V_{IH} limits. The input LOW voltage level at which oscillation occurs is defined as V_{ILD} .
- Next decrease the input HIGH voltage level on the, V_{IH} , until the output begins to oscillate or steps out a min of 2 ns. Oscillation is defined as noise on the output LOW level that exceeds V_{IL} limits, or on output HIGH levels that exceed V_{IH} limits. The input HIGH voltage level at which oscillation occurs is defined as V_{IHD} .
- Verify that the GND reference recorded on the oscilloscope has not drifted to ensure the accuracy and repeatability of the measurements.

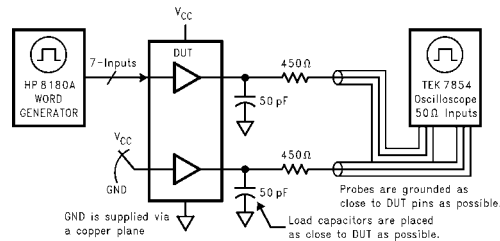
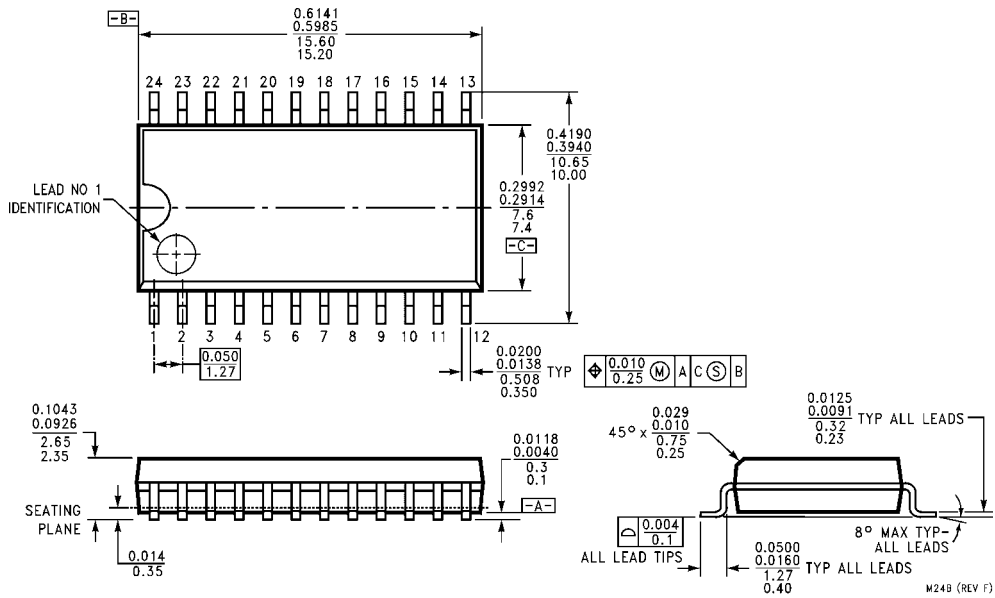

FIGURE 2. Simultaneous Switching Test Circuit

Physical Dimensions inches (millimeters) unless otherwise noted



**24-Lead Small Outline Integrated Circuit (SOIC), JEDEC MS-013, 0.300 Wide
Package Number M24B**

Physical Dimensions inches (millimeters) unless otherwise noted (Continued)

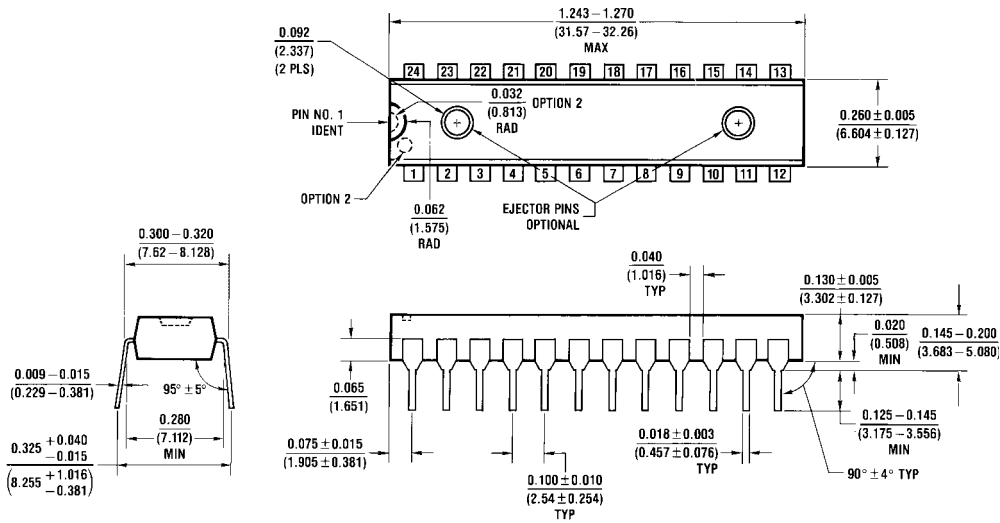

N24C (REV F)

**24-Lead Plastic Dual-In-Line Package (PDIP), JEDEC MS-001, 0.300 Wide
 Package Number N24C**

Fairchild does not assume any responsibility for use of any circuitry described, no circuit patent licenses are implied and Fairchild reserves the right at any time without notice to change said circuitry and specifications.

LIFE SUPPORT POLICY

FAIRCHILD'S PRODUCTS ARE NOT AUTHORIZED FOR USE AS CRITICAL COMPONENTS IN LIFE SUPPORT DEVICES OR SYSTEMS WITHOUT THE EXPRESS WRITTEN APPROVAL OF THE PRESIDENT OF FAIRCHILD SEMICONDUCTOR CORPORATION. As used herein:

1. Life support devices or systems are devices or systems which, (a) are intended for surgical implant into the body, or (b) support or sustain life, and (c) whose failure to perform when properly used in accordance with instructions for use provided in the labeling, can be reasonably expected to result in a significant injury to the user.
2. A critical component in any component of a life support device or system whose failure to perform can be reasonably expected to cause the failure of the life support device or system, or to affect its safety or effectiveness.

www.fairchildsemi.com