



# KBJ4AU thru KBJ4MU

Glass Passivated Single-Phase Bridge Rectifiers  
Reverse Voltage 50 to 1000 Volts Forward Current 4.0 Amperes

## Features

- ◆ Ideal for printed circuit boards
- ◆ High surge current capability
- ◆ High case dielectric strength of 2000  $V_{RMS}$
- ◆ Glass passivated chip junction
- ◆ Plastic package has Underwriters Laboratory Flammability Classification 94V-0

## Mechanical Data

- ◆ Case: KBJ(3S)  
Epoxy meets UL-94V-0 Flammability rating
- ◆ Terminals: Plated leads solderable per MIL-STD-750, Method 2026
- ◆ High temperature soldering guaranteed:  
260°C/10 seconds, 0.375 (9.5mm) lead length,  
5lbs.(2.3kg) tension
- ◆ Polarity: As marked on body
- ◆ Mounting Torque: 10 cm-kg (8.8 inches-lbs) max.
- ◆ Recommended Torque: 5.7 cm-kg (5 inches-lbs)

## Typical Applications

General purpose use in ac-to-dc bridge full wave rectification for Monitor, TV, Printer, Switching Mode Power Supply, Adapter, Audio equipment, and Home Appliances applications

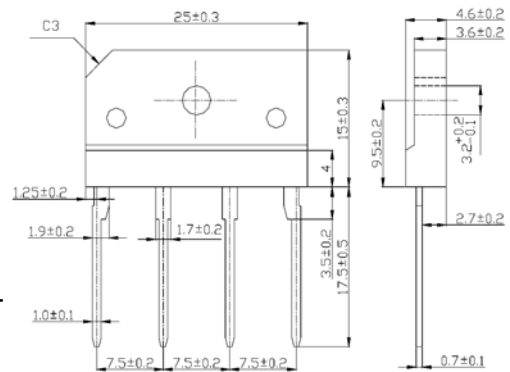
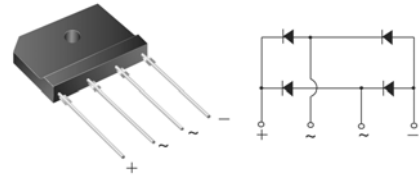

Package outline dimensions in millimeters

## Maximum Ratings and Electrical Characteristics

Rating at 25°C ambient temperature unless otherwise specified.

Parameter	Symbols	KBJ4AU	KBJ4BU	KBJ4DU	KBJ4GU	KBJ4JU	KBJ4KU	KBJ4MU	Units
Maximum repetitive peak reverse voltage	$V_{RRM}$	50	100	200	400	600	800	1000	Volts
Maximum RMS voltage	$V_{RMS}$	35	70	140	280	420	560	700	Volts
Maximum DC blocking voltage	$V_{DC}$	50	100	200	400	600	800	1000	Volts
Maximum average forward rectified output current at $T_C=100^\circ\text{C}$ $T_A=25^\circ\text{C}$	$I_{F(AV)}$	4.0 <sup>(1)</sup> 2.3 <sup>(2)</sup>							Amps
Peak forward surge current, 8.3ms single half sine-wave superimposed on rated load (JEDEC Method)	$I_{FSM}$	120							Amps
Rating for fusing (t<8.3ms)	$I^2t$	60							A <sup>2</sup> sec
Maximum instantaneous forward voltage drop per leg at 2.0A	$V_F$	1.0							Volt
Maximum DC reverse current at rated DC blocking voltage per leg $T_A=25^\circ\text{C}$ $T_R=125^\circ\text{C}$	$I_R$	5 250							uA
Typical thermal resistance per leg	$R_{\theta JA}$ $R_{\theta JC}$	26 <sup>(2)</sup> 5 <sup>(1)</sup>							°C/W
Dielectric strength (Terminals to case, AC 1 minute)	$V_{ISO}$	2000							Volts
Operating junction and storage temperature range	$T_J, T_{STG}$	-55 to +150							°C

- Notes:**
1. Unit case mounted on 6.3x6.3x0.15cm thick Al plate heatsink.
  2. Units mounted on P.C.B. with 0.5 x 0.5" (13 x 13 mm) copper pads and 0.375" (9.5 mm) lead length
  3. Recommended mounting position is to bolt down on heatsink with silicone thermal compound for maximum heat transfer with #6 screw

## RATINGS AND CHARACTERISTIC CURVES

( $T_A = 25^\circ\text{C}$  unless otherwise noted)

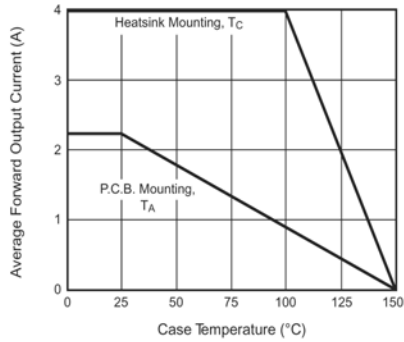

Figure 1. Derating Curve Output Rectified Current

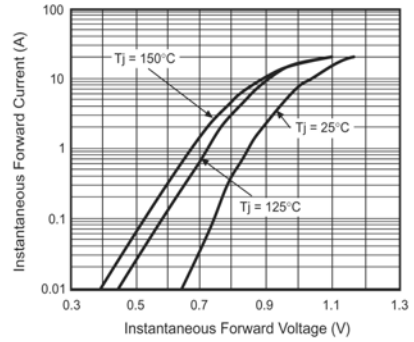

Figure 3. Typical Instantaneous Forward Characteristics Per Leg

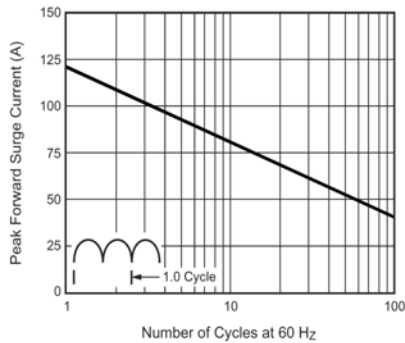

Figure 2. Maximum Non-Repetitive Peak Forward Surge Current Per Leg

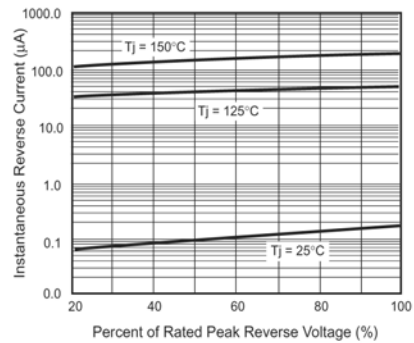

Figure 4. Typical Reverse Characteristics Per Leg

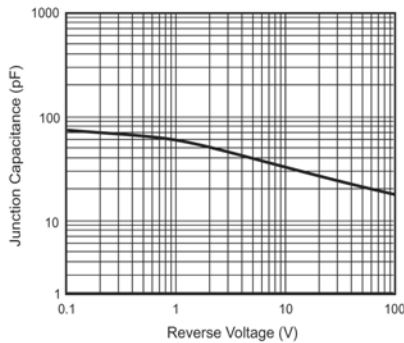

Figure 5. Typical Junction Capacitance Per Leg

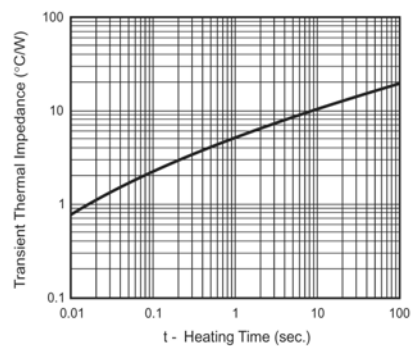

Figure 6. Typical Transient Thermal Impedance Per Leg