

REV.	DATE	ECR NO.	DESCRIPTION
NC	08/18/08	100046	INITIAL RELEASE

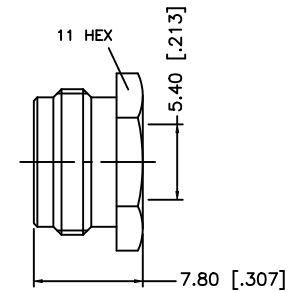
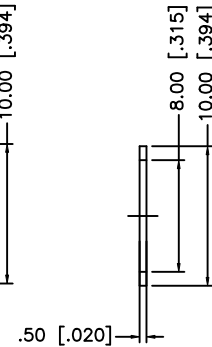
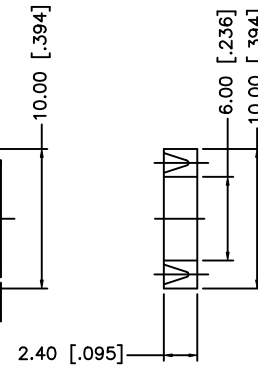
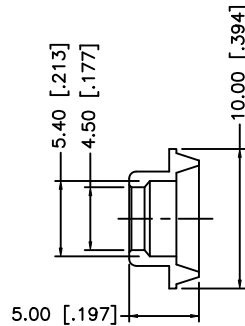
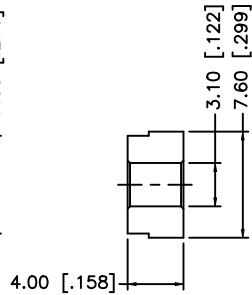
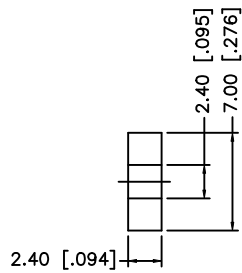
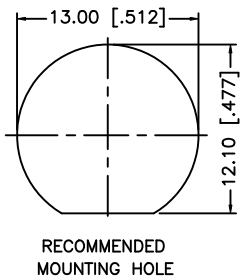
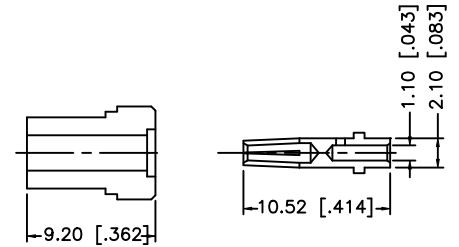
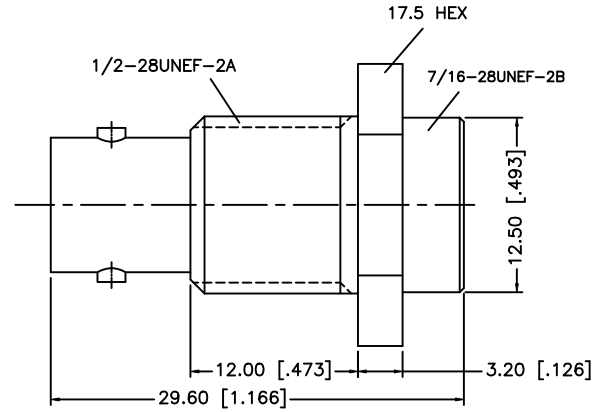
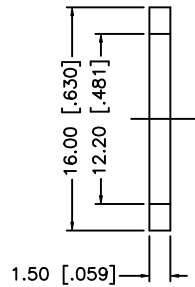
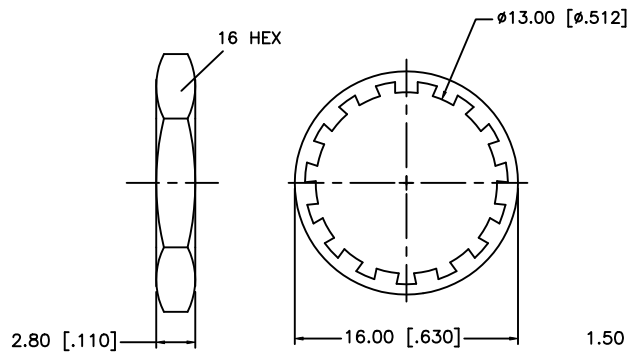
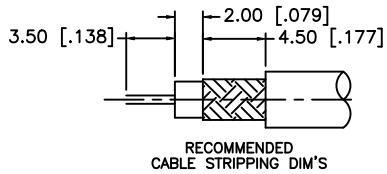

13	HEX NUT	BRASS	NICKEL	1
12	WASHER	BRASS	NICKEL	1
11	GASKET	SILICONE	RED	1
10	BRAID CLAMP	BRASS	NICKEL	1
9	RING	BRASS	NICKEL	1
8	INSULATOR	PTFE	NATURAL	1
7	CONTACT PIN	PHOS. BRONZE	GOLD	1
6	INSULATOR	PTFE	NATURAL	1
5	HEX NUT	BRASS	NICKEL	1
4	LOCK WASHER	BRASS	NICKEL	1
3	GASKET	RUBBER	RED	1
2	HOUSING	BRASS	NICKEL	1
1	BODY	BRASS	NICKEL	1
	DESCRIPTION	MATERIAL	FINISH	QTY

UNLESS OTHERWISE SPECIFIED DIMENSIONS ARE IN MILLIMETERS. DIMENSIONS IN [] ARE IN INCHES AND FOR CUSTOMER REFERENCE ONLY.

UNLESS OTHERWISE SPECIFIED TOLERANCES FOR MILLIMETERS ARE:
0.5 - 8mm ± 0.20mm
8 - 30mm ± 0.40mm
30 - 120mm ± 0.50mm

UNLESS OTHERWISE SPECIFIED TOLERANCES FOR INCHES ARE:
.020 - .315 = ± 0.007"
.315 - 1.180 = ± 0.015"
1.180 - 4.724 = ± 0.020"

DO NOT SCALE DRAWING

APPROVALS		DATE
DRAWN	GRS	08/18/08
CHECKED		
ISSUED		
SHEET	1 OF 1	
CAD FILE	C:/112/112577.DWG	

Amphenol Connex

BNC BULKHEAD CLAMP JACK
(FOR RG-58/U, 58B/U)

PART DESCRIPTION

PART NO.

112577

DWG. NO.

112577.DWG

REV. NC

SIZE A

SCALE NA

NOTE:
1. CONTACT PIN TO SOLDER.