

RTKA223021DE0010BU

The [RAA223021](#) evaluation board (RTKA223021DE0010BU) is a high voltage flyback converter that is designed to demonstrate a low-cost high performance isolated AC/DC conversion from a universal input of 85V_{AC} to 265V_{AC}, to a 12V output with the output current up to 1A.

The board has a built-in overcurrent, short-circuit, input brownout and over-temperature protections, and is designed on a double side Printed Circuit Board (PCB) with a full-wave input rectification. It is pre-compliant with the conducted EMI requirements by EN55022/CISPR 22. The RTKA223021DE0010BU uses the RAA223021 SOIC-7 packaged IC.

Features

- Universal input
- EMI compliance for EN55022/CISPR22
- Standby power less than 50mW
- No audible noise

Specifications

This board is optimized for the following operating conditions:

- Input voltage: 85V_{AC} ~ 265V_{AC}
- Output voltage: 12V_{DC}
- Output current: 1A maximum
- Output power: 12W
- Efficiency: >78% at 100% load; 80% at 50% load
- No-load power: 50mW
- Load regulation: ±0.1%
- Operating temperature: -40°C~85°C
- Board dimension: 70mm x 75mm

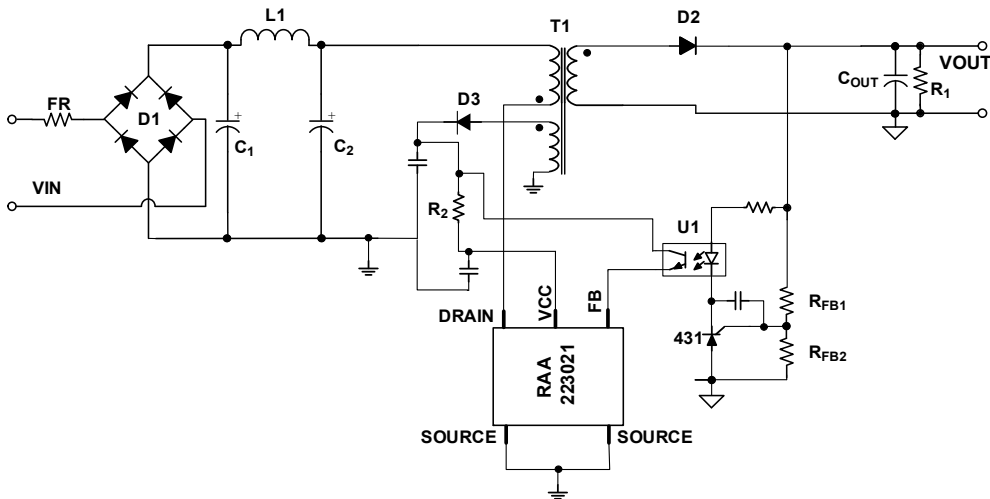

Figure 1. RTKA223021DE0010BU Block Diagram

Contents

1. Functional Description	3
1.1 Recommended Equipment and Operating Range	3
1.2 Quick Test Guide	3
2. Board Design	4
2.1 PCB Layout Guidelines	5
2.2 Schematic Drawings	6
2.3 Bill of Materials	8
2.4 Board Layout	9
3. Typical Performance Graphs	10
4. EMI Test Results	12
5. Ordering Information	12
6. Revision History	12

1. Functional Description

The RTKA223021DE0010BU is a flyback regulator implemented with constant off control. D1 is a full bridge rectifier on the input end. FR is 1A fuse providing input overcurrent protection. As an option, you can replace the standard fuse with a fusible resistor instead to limit inrush current.

C1, L1, and C2 consist of the input filter that provides the energy buffer after rectification and reduces the conducted EMI noises to the input. RAA223021, T1, and D2 configures the flyback converter. RFB1, RFB2, 431, and U1 provide the output feedback signal to the IC. D3 and R2 provide V_{CC} biasing current after startup, to increase the efficiency. They can be optional for low-cost low power applications.

1.1 Recommended Equipment and Operating Range

- AC power supply capable of generating AC voltage from $85V_{AC}$ to $265V_{AC}$ at 60Hz/50Hz, with at least 100mA output current capability.
- Load resistor box with adjustable value of 12Ω and up, or an electronics load that can emulate a resistor load or current load up to 1A.
- Multimeters to measure the output voltage and current.
- Power meter to measure the AC input power.

1.2 Quick Test Guide

1. Program the AC power supply with a voltage between $85V_{AC}$ and $265V_{AC}$ at the corresponding frequency of 60Hz or 50Hz.
2. While the AC power supply is off, connect the output cables of the AC power supply to the VIN+ and VIN- terminals of the RTKA223021DE0010BU. An optional power meter can be added in between the AC power supply output and the input of the board.
3. Connect the load to the output terminals VOUT and GND.
4. Connect a voltage meter to VOUT and GND and connect a current meter between the board output and the load.
5. Turn on the AC power supply.

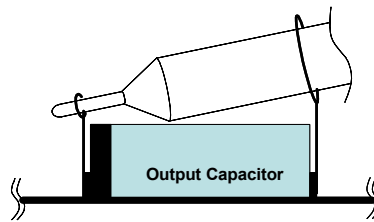

Figure 2. Proper Probe Setup to Measure Output Ripple

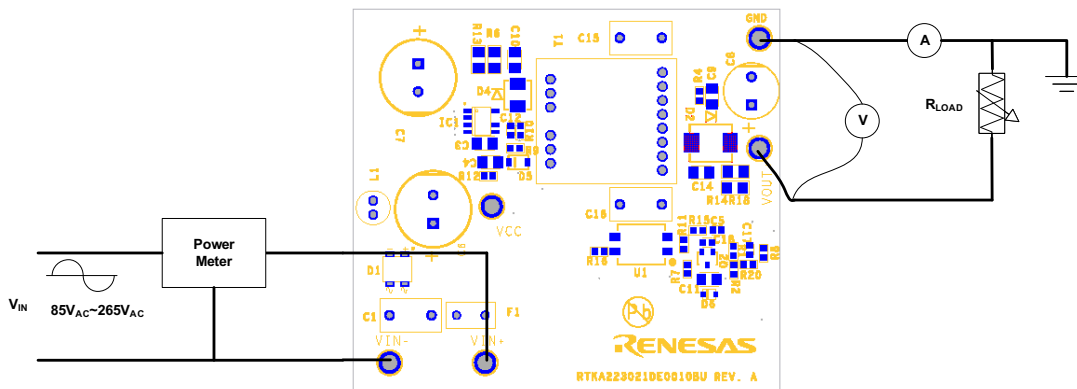

Figure 3. Proper Test Setup

2. Board Design

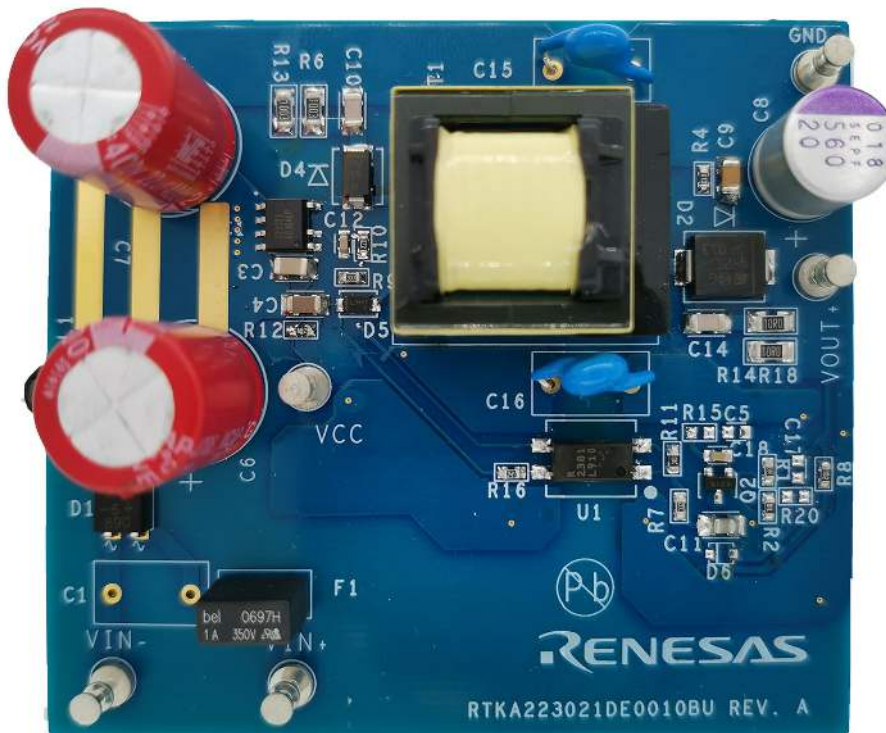

Figure 4. RTKA223021DE0010BU Board, Top View

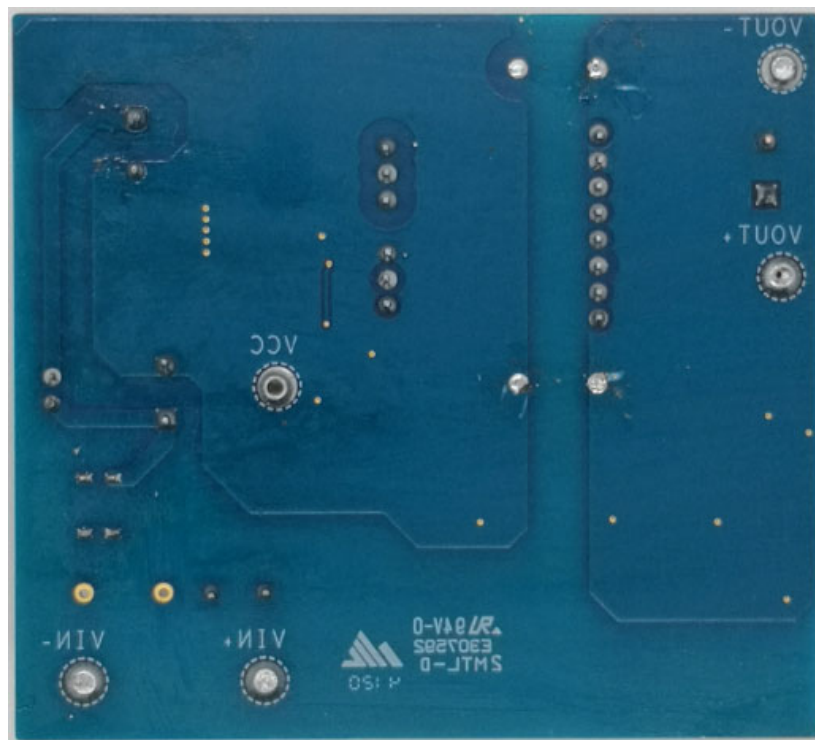

Figure 5. RTKA223021DE0010BU Board, Bottom View

2.1 PCB Layout Guidelines

Proper layout is important to ensure a stable operation, good thermal behavior, EMI performance, and reliable operation for various operating environments. **Note:** Pay attention to the following layout recommendations.

- Leave proper spacing (minimum 2mm) between the high voltage traces (maximum 400V) and the low voltage traces and between the primary and secondary circuit.
- Keep a small loop from the input filter capacitor to IC and transformer.
- Keep a small loop consisted of a switching transformer, output capacitor, and freewheeling diode.
- Keep a small loop consisted of an input filter capacitor to IC and snubber circuit.
- Keep a sufficient copper area on the IC source pins for better thermal performance.
- Keep the switching node away from the input EMI inductor to avoid noise coupling, especially when an unshielded inductor is used.
- Place the V_{CC} decoupling capacitor and the FB pin decoupling capacitor close to the pins.

2.2 Schematic Drawings

2.2.1 RTKA223021DE0010BU Circuit

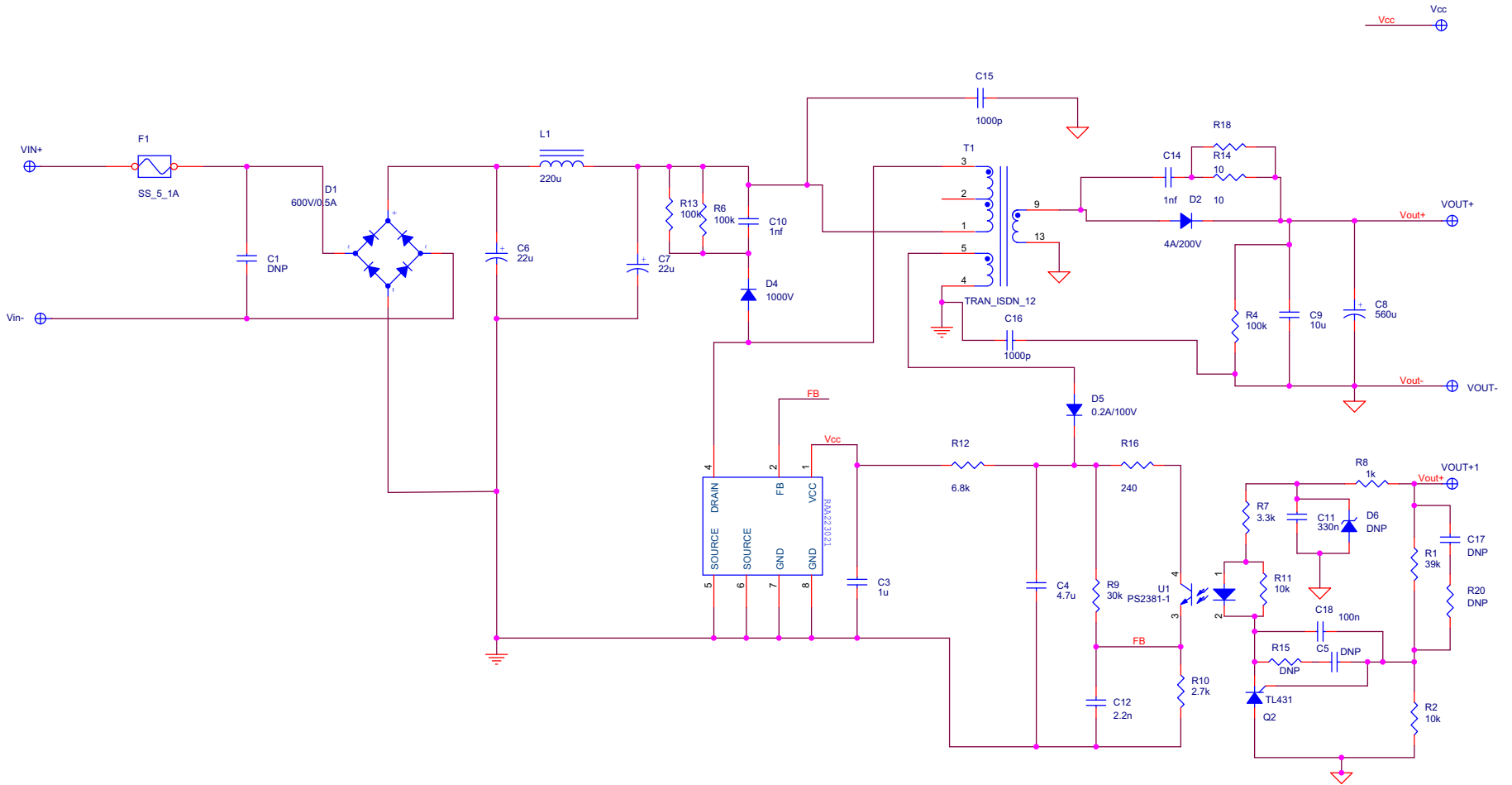

Figure 6. Schematic

2.2.2 Transformer Information

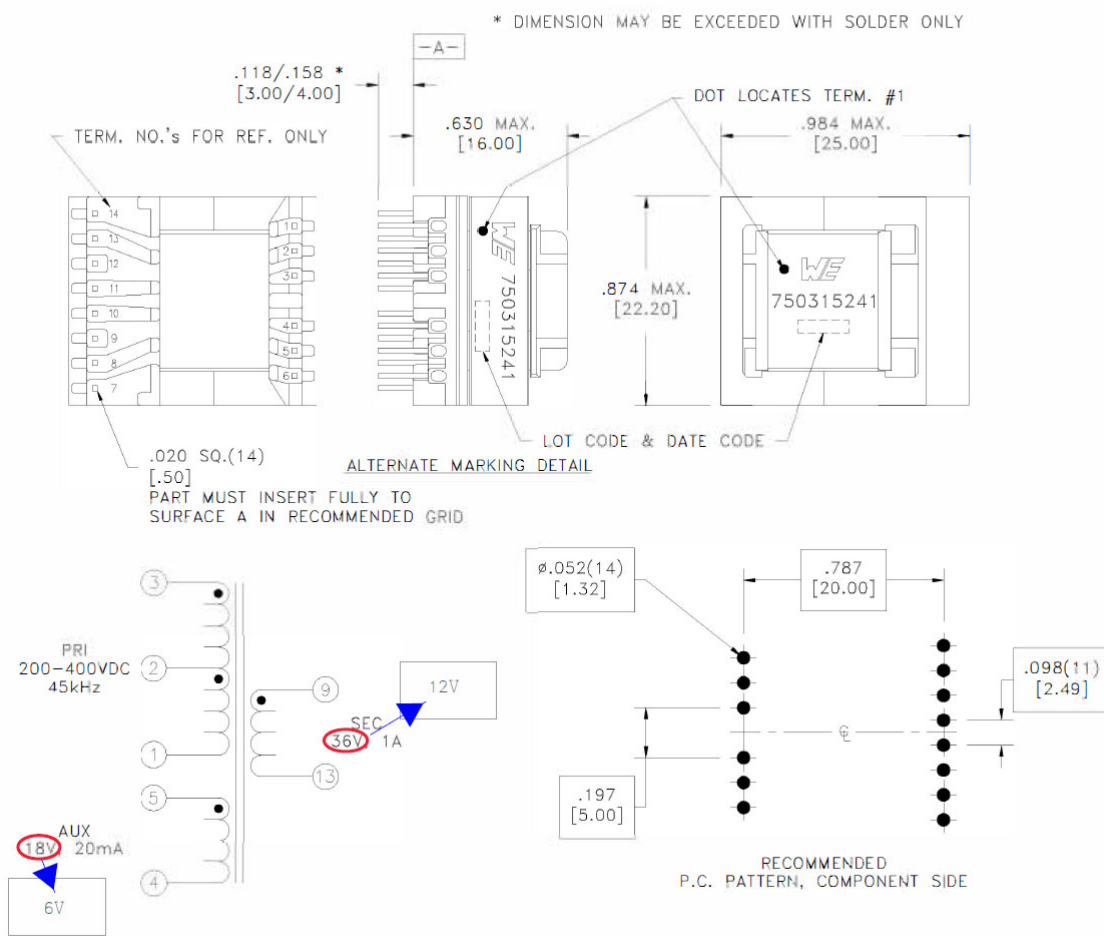

Figure 7. Transformer Schematic

Electrical Specifications at 25°C unless otherwise noted

Parameter	Test Conditions	Value
D.C. Resistance	3-1 at 20°C	2.10Ω ±10%
D.C. Resistance	5-4 at 20°C	0.600Ω ±10%
D.C. Resistance	9-13 at 20°C	0.125Ω ±10%
Inductance	3-1 10kHz, 100mVAC, Ls	1.10mH ±1 0%
Saturation Current	3-1 20% roll off from initial	1.3A
Leakage Inductance	3-1 tie(4 +5, 9 +13), 100kHz, 100mVAC, Ls	21.0μH typical, 35.0μH maximum
Dielectric	1-13 tie(3+4), 3750VAC, 1s	3000VAC, 1min
Dielectric	1-5 625VAC, 1s	-
Turns Ratio	(3 - 2):(2 - 1)	1:1, ±1%
Turns Ratio	(3-1):(5-4)	8:1, ±1%
Turns Ratio	(3-1):(9-13)	4:1, ±1%

2.3 Bill of Materials

Qty	Reference Designator	Description	Manufacturer	Manufacturer Part
1	C3	CAP CER 1 μ F 25V X7R 1206	TDK	CGJ5L2X7R1E105K160AA
1	C4	CAP CER 4.7 μ F 25V X7R 1206	TDK	C3216X7R1E475K160AC
2	C6, C7	Aluminum Electrolytic Capacitors - Radial Leaded WCAP-AT1H 22 μ F 400V 20% Radia	WE	860241378003
1	C8	Aluminum Organic Polymer Capacitors 20V 560 μ F ESR 12m Ω	Panasonic	20SEPF560M
1	C9	CAP CER 10 μ F 25V X7R 1206	TDK	C3216X7R1E106K160AB
2	C10, C14	CAP CER 1000PF 630V X7R 1206	TDK	C3216X7R2J102K115AE
1	C11	CAP CER 0.33 μ F 25V X7R 1206	TDK	C3216X7R1E334M
1	C12	CAP CER 2200PF 50V X7R 0603	TDK	CGA3E2X7R1H222K080A A
2	C15, C16	CAP 7mm X1/Y1 1000pF E 20%	TDK	CD45-E2GA102M-VKA
1	C18	SMD/SMT CGA 0603 50V 0.1 μ F X7R 10%	TDK	CGA3E2X7R1H104K080A A
1	D1	Bridge Rectifiers 600V, 0.5A, 35A IFSM	Vishay	MB6M
1	D2	Rectifiers Ultrafast Recovery 4A 200V 16ns Planar Pt	ST	STTH4R02S
1	D4	Rectifiers 1000Vr 700Vrms 1000V 17pF	MCC	UF1M-TP
1	D5	DIODE SCHOTTKY 100V 1A SOD123FL	ON Semiconductor	MBR1H100SFT3G
1	F1	Fuses with Leads (Through Hole) 1A 250V SS-5H RADIAL TD FUSE	Eaton	SS_5_1A
1	IC1	700V, 8W AC/DC Buck Regulator	Renesas Electronics	RAA223021
1	L1	Fixed Inductors WE-TI RadXtnd Ld5075 WW220 230H 0.50A 0.96 Ω	WE	7447462221
1	Q2	Linear Voltage Regulators 37V 0.30W 36Vref 100mA 17mV 0.5 μ A	MCC	TL431K-TP
1	R1	RES 39k Ω 1% 1/10W 0603	Yageo	RT0603FRD0739KL
2	R2, R11	RES 10k Ω 1% 1/10W 0603	Yageo	RC0603FR-0710KL
1	R4	RES 100k Ω 1% 1/10W 0603	Yageo	RC0603FR-07100KL
2	R6, R13	RES 100k Ω 1% 1/4W 1206	Yageo	AT1206BRD07100KL
1	R7	RES 3.3k Ω 1% 1/10W 0603	Yageo	RC0603FR-0733KL
1	R8	RES 1k Ω 1% 1/10W 0603	Yageo	RC0603FR-071KL
1	R9	RES 30k Ω 1% 1/10W 0603	Yageo	RC0603FR-0730KL
1	R10	RES 2.7k Ω 1% 1/10W 0603	Yageo	RC0603FR-132K7L
1	R12	RES 6.8k Ω 1% 1/10W 0603	Yageo	RT0603FRD076K8L
2	R14, R18	Thick Film Resistors - SMD 10 Ω 1% 200V General Purpose	Yageo	RC1206FR-1010RL

Qty	Reference Designator	Description	Manufacturer	Manufacturer Part
1	R16	Thick Film Resistors - SMD 240Ω 1% 200V General Purpose	Yageo	RC0603FR-13240RL
1	T1	MID-OLTI Offline Flyback Transformers	WE	750315241
1	U1	Transistor Output Optocouplers BV = 5000Vr.m.s. - 40C + 115C	Renesas Electronics	PS2381-1Y-F3-AX
6	VOUT+1, Vin-, VCC, VOUT-, VOUT+, VIN+	CONN-DBL TURRET, TH, 0.109LENGTH, BRASS/TIN, ROHS	Keystone Electronics	1514-2

2.4 Board Layout

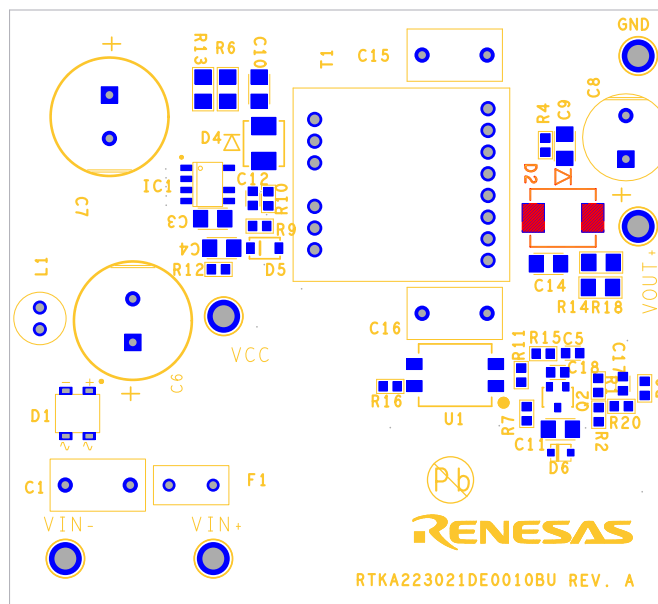

Figure 8. Top Layer

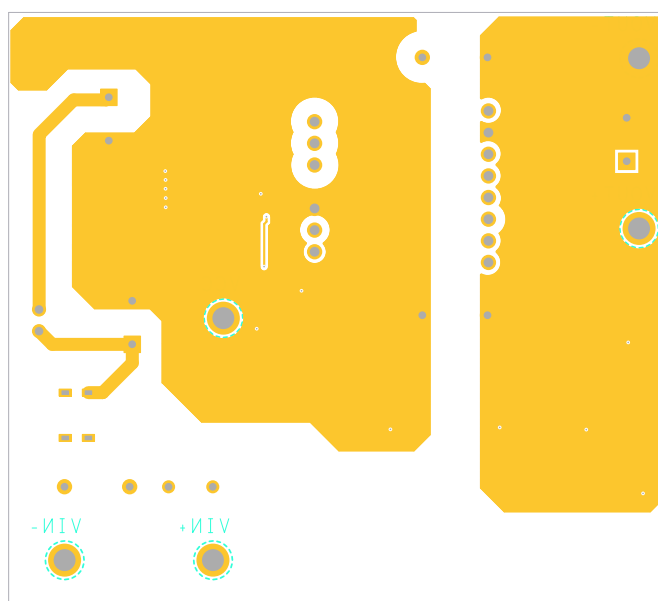

Figure 9. Bottom Layer

3. Typical Performance Graphs

$V_{IN} = 220V_{AC}$, unless otherwise noted.

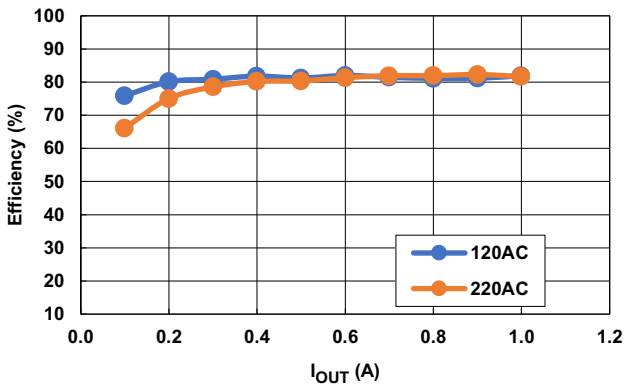

Figure 10. Flyback Efficiency

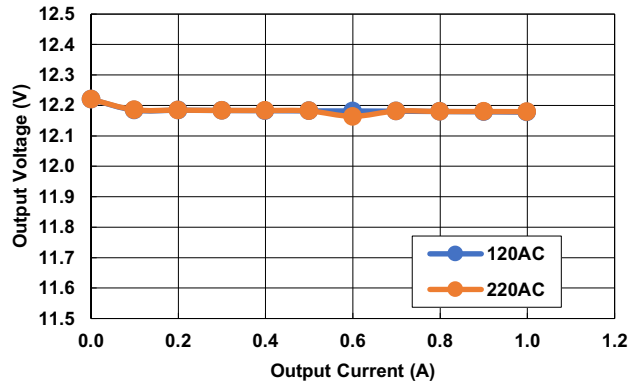

Figure 11. Output Regulation

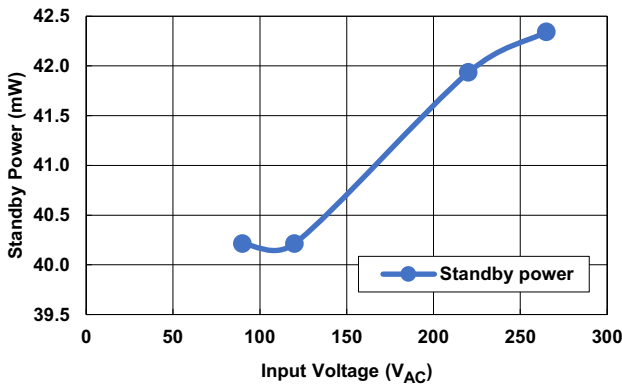

Figure 12. No Load Power Loss

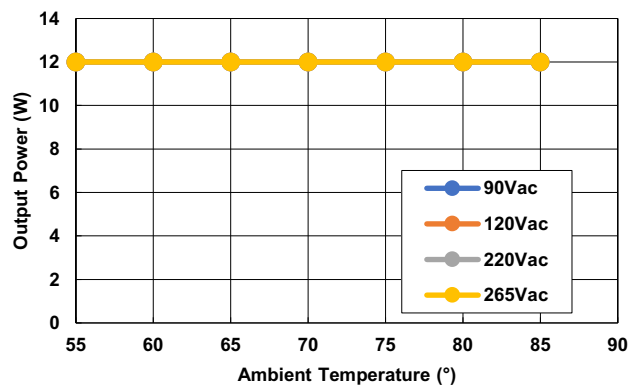

Figure 13. Power Derating

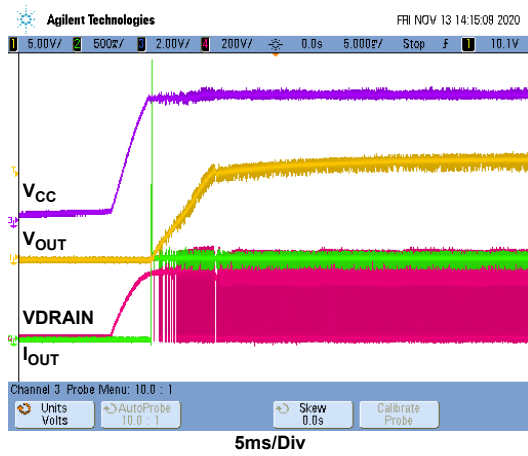

Figure 14. Soft-Start, $I_{OUT} = 1A$

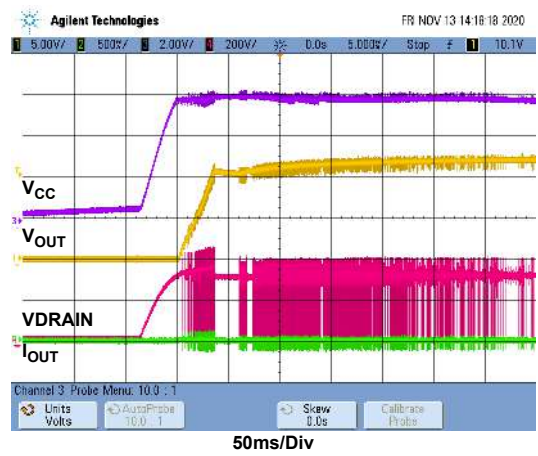

Figure 15. Soft-Start, $I_{OUT} = 0A$

$V_{IN} = 220V_{AC}$, unless otherwise noted. (Continued)

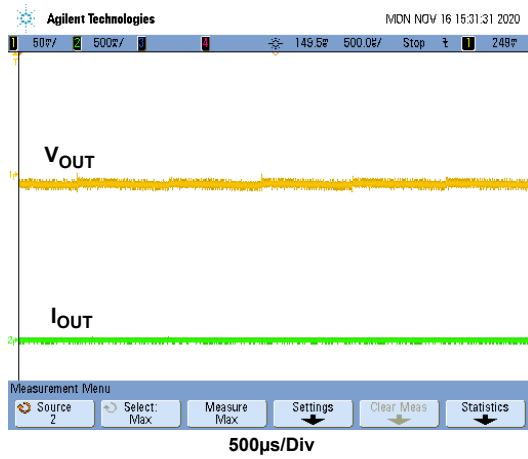

Figure 16. Output Ripple at 0A Load

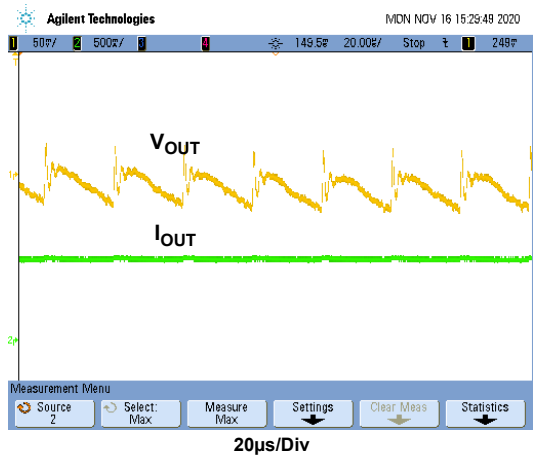

Figure 17. Output Ripple at 1A Load

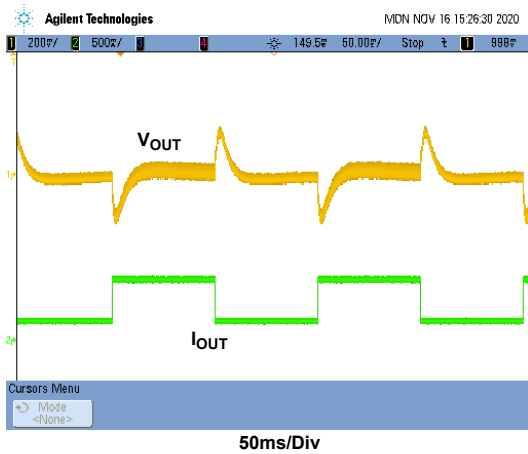

Figure 18. Dynamic Load (25% ~ 75%)

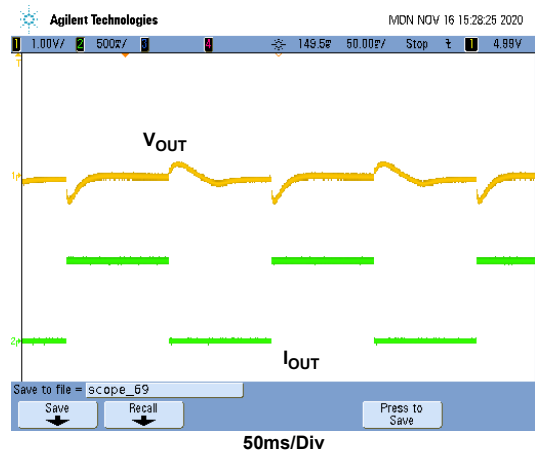

Figure 19. Dynamic Load (0% ~ 100%)

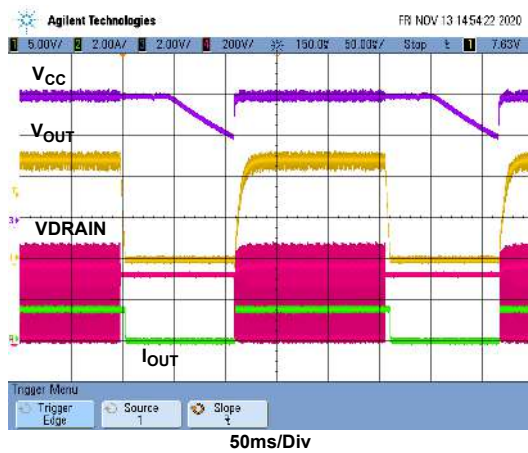

Figure 20. OLP

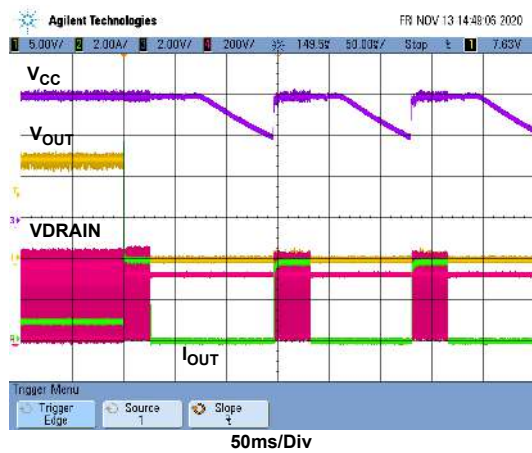

Figure 21. $I_{OUT} = 0.667A$ to Short

4. EMI Test Results

Conducted EMI compliance for EN55022/CISPR22 (12V/600mA output)

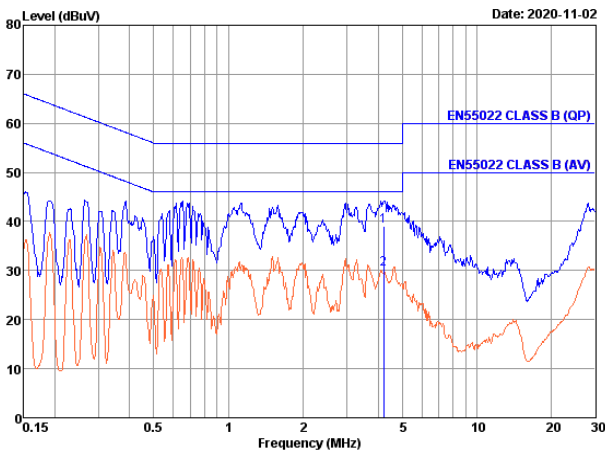

Figure 22. Line, 230V_{AC}

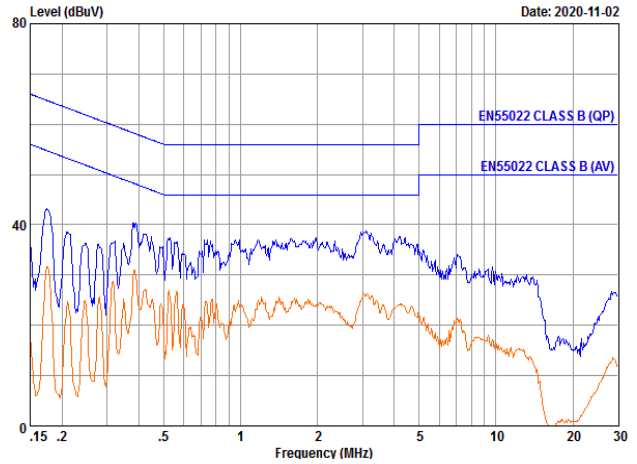

Figure 23. Line, 120V_{AC}

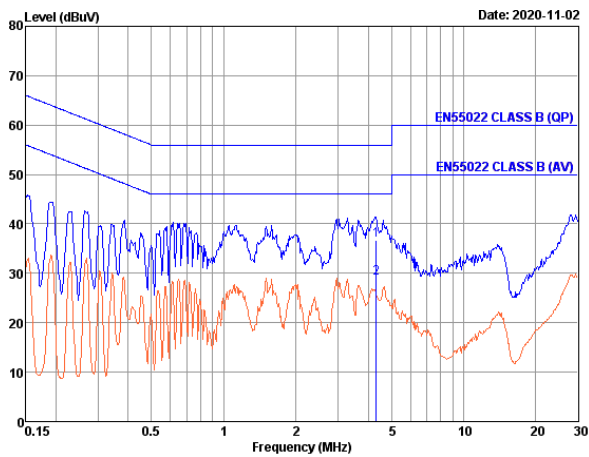

Figure 24. Neutral, 230V_{AC}

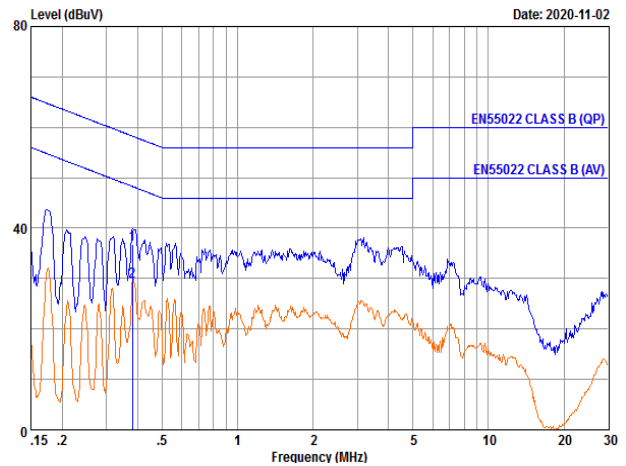

Figure 25. Neutral, 120V_{AC}

5. Ordering Information

Part Number	Description
RTKA223021DE0010BU	High voltage flyback converter evaluation board

6. Revision History

Rev.	Date	Description
1.1	Mar 26, 2021	Applied new template. Updated Figure 1 and made text updates throughout.
1.0	Dec 11, 2020	Initial release

IMPORTANT NOTICE AND DISCLAIMER

RENESAS ELECTRONICS CORPORATION AND ITS SUBSIDIARIES (“RENESAS”) PROVIDES TECHNICAL SPECIFICATIONS AND RELIABILITY DATA (INCLUDING DATASHEETS), DESIGN RESOURCES (INCLUDING REFERENCE DESIGNS), APPLICATION OR OTHER DESIGN ADVICE, WEB TOOLS, SAFETY INFORMATION, AND OTHER RESOURCES “AS IS” AND WITH ALL FAULTS, AND DISCLAIMS ALL WARRANTIES, EXPRESS OR IMPLIED, INCLUDING, WITHOUT LIMITATION, ANY IMPLIED WARRANTIES OF MERCHANTABILITY, FITNESS FOR A PARTICULAR PURPOSE, OR NON-INFRINGEMENT OF THIRD PARTY INTELLECTUAL PROPERTY RIGHTS.

These resources are intended for developers skilled in the art designing with Renesas products. You are solely responsible for (1) selecting the appropriate products for your application, (2) designing, validating, and testing your application, and (3) ensuring your application meets applicable standards, and any other safety, security, or other requirements. These resources are subject to change without notice. Renesas grants you permission to use these resources only for development of an application that uses Renesas products. Other reproduction or use of these resources is strictly prohibited. No license is granted to any other Renesas intellectual property or to any third party intellectual property. Renesas disclaims responsibility for, and you will fully indemnify Renesas and its representatives against, any claims, damages, costs, losses, or liabilities arising out of your use of these resources. Renesas' products are provided only subject to Renesas' Terms and Conditions of Sale or other applicable terms agreed to in writing. No use of any Renesas resources expands or otherwise alters any applicable warranties or warranty disclaimers for these products.

(Rev.1.0 Mar 2020)

Corporate Headquarters

TOYOSU FORESIA, 3-2-24 Toyosu,
Koto-ku, Tokyo 135-0061, Japan
www.renesas.com

Contact Information

For further information on a product, technology, the most up-to-date version of a document, or your nearest sales office, please visit:
www.renesas.com/contact/

Trademarks

Renesas and the Renesas logo are trademarks of Renesas Electronics Corporation. All trademarks and registered trademarks are the property of their respective owners.