

6

5

4

3

2

1

Rev	AWO #	Description	Date	Appr
-		RELEASED	5/22/15	

APPROVED: \_\_\_\_\_

DATE: \_\_\_\_\_ TITLE: \_\_\_\_\_

# DE09-HD-PX-SS

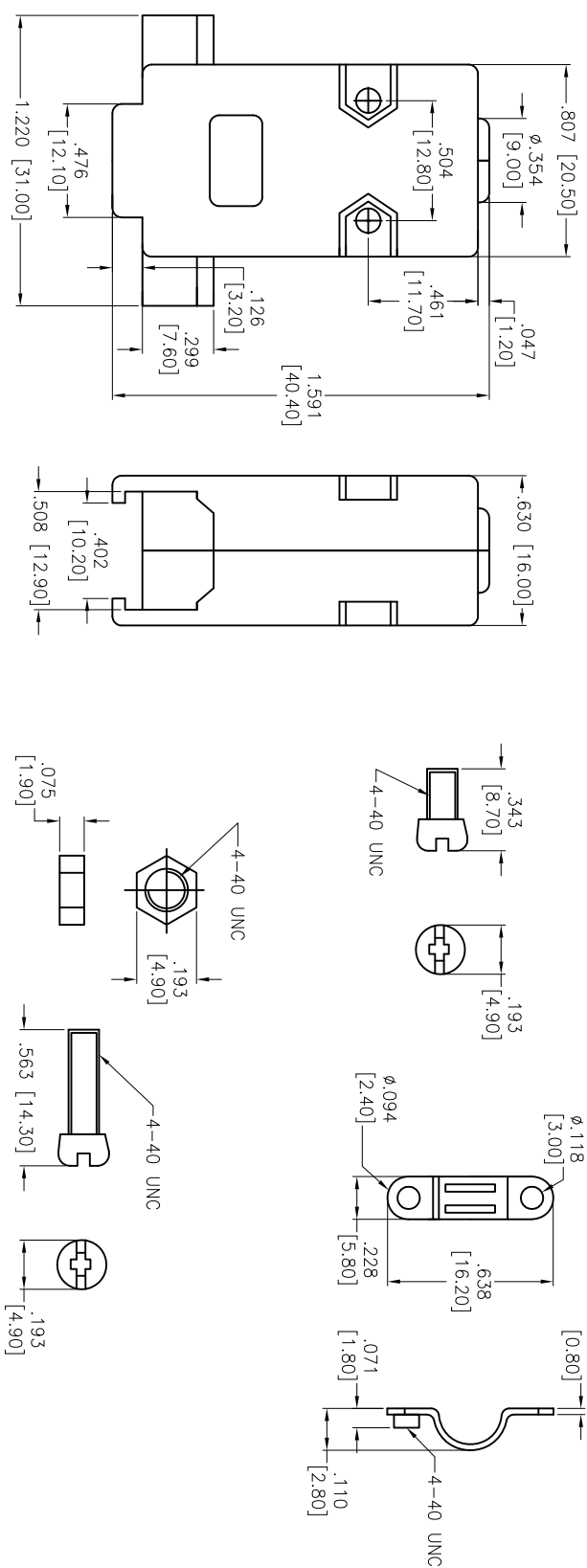
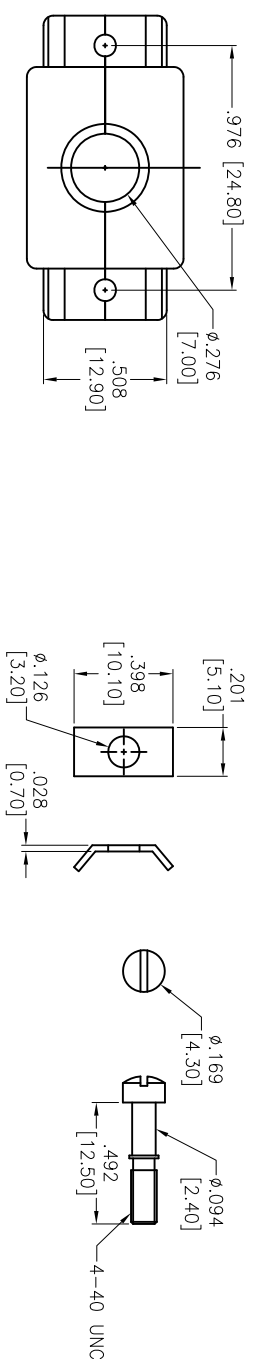

ADAM P/N	HOOD COLOR
DXXX-HD-PB-SS	BLACK PLASTIC
DXXX-HD-PN-SS	CHROME PLASTIC
DXXX-HD-PY-SS	GRAY PLASTIC

UNLESS OTHERWISE SPECIFIED ALL DIMENSIONS ARE INCHES [MM]	
TOLERANCES: EXCEPT AS NOTED	
INCHES	
.X ± .10	$\phi$ X ± .10
.XX ± .020	$\phi$ XX ± .015
.XXX ± .015	$\phi$ XXX ± .010
APPROVALS	
DRAWN	HR
CHECKED	LL
APPROVED	

**ADAM TECH**  
 909 Railway Avenue, Union, NJ 07083  
 Phone: 908-687-5000 Fax: 908-687-5710

**D-SUB HOOD, SHORT SCREWS**

**SPECIFICATIONS:**  
 Material: Insulator: ABS, rated UL 94HB  
 Hardware color: Black  
 Hardware: Steel, Chromate plated  
 Environmental: Lead free, RoHS compliant



SIZE	PART NO.	REV.
X	DXXX-HD-PX-SS	-
REF:	S00064T	SHEET 1 OF 5
SCALE:	NTS	

6

5

4

3

2

1

6

5

4

3

2

1

Rev	AWO #	Description	Date	Appr
		SEE SHT 1 OF 5 FOR REVISION		

APPROVED: \_\_\_\_\_

DATE: \_\_\_\_\_ TITLE: \_\_\_\_\_

# DA15-HD-PX-SS

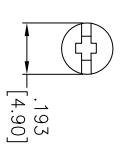
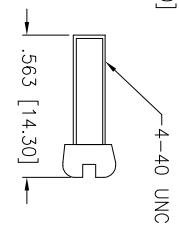
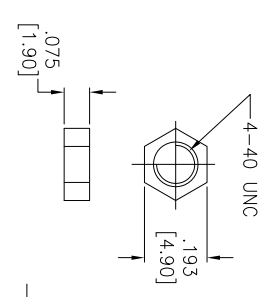
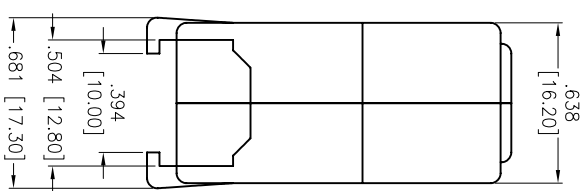
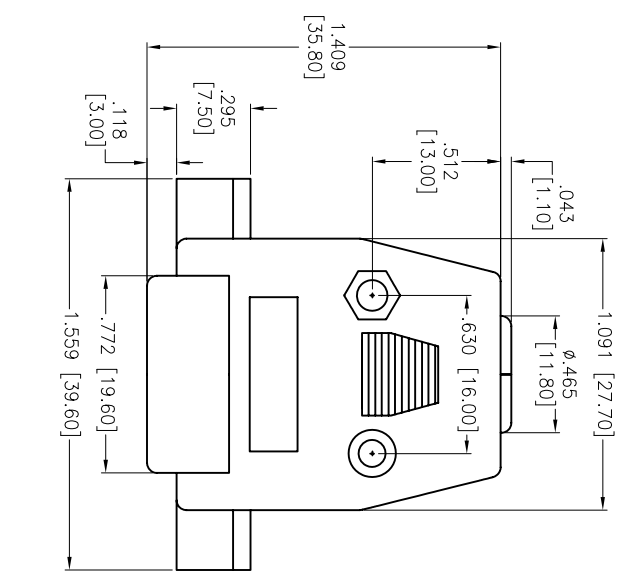
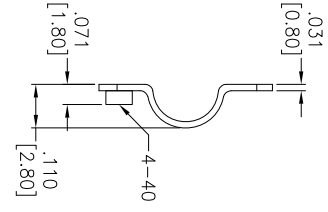
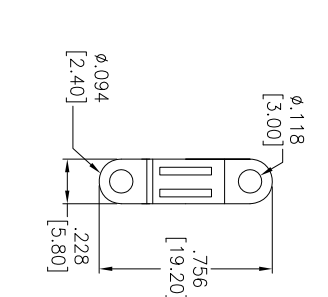
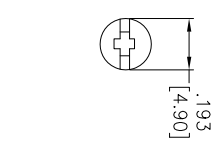
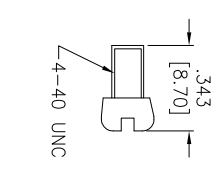
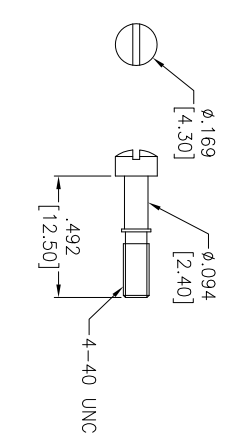
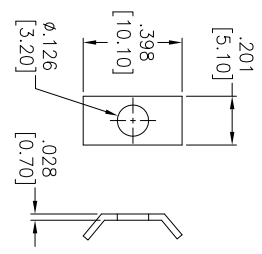
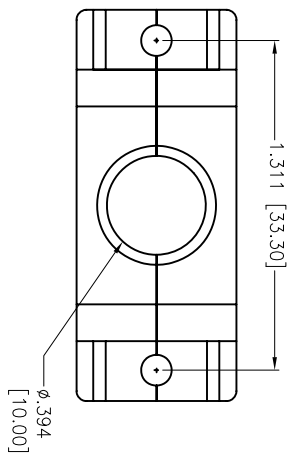

A

B

C

D

A

B

C

D

6

5

4

3

2

1

UNLESS OTHERWISE SPECIFIED  
ALL DIMENSIONS ARE INCHES [MM]  
TOLERANCES: EXCEPT AS NOTED

.X	± .10	ØX	± .10
.XX	± .020	ØXX	± .015
.XXX	± .015	ØXXX	± .010

INCHES

HOLDS

APPROVALS

DRAWN	HR	DATE
CHECKED	LL	5/22/15
APPROVED		

**ADAM TECH**  
909 Railway Avenue, Union, NJ 07083  
Phone: 908-687-5000 Fax: 908-687-5710

TITLE: D-SUB HOOD, SHORT SCREWS

SIZE	PART NO.	REV.
X	DXXX-HD-PX-SS	-
REF:	S00064T	SCALE: NTS
		SHEET 2 OF 5

6

5

4

3

2

1

Rev	AWO #	Description	Date	Appr
		SEE SH1 1 OF 5 FOR REVISION		

APPROVED: \_\_\_\_\_  
 DATE: \_\_\_\_\_ TITLE: \_\_\_\_\_

DB25-HD-PX-SS

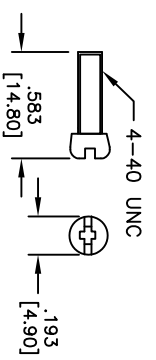
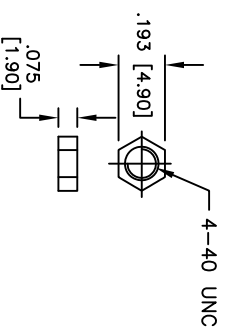
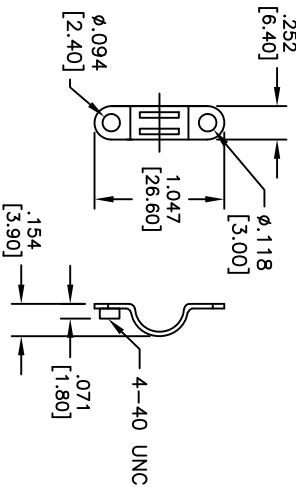
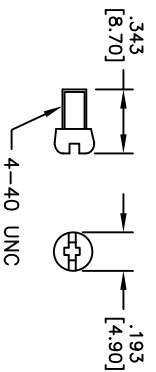
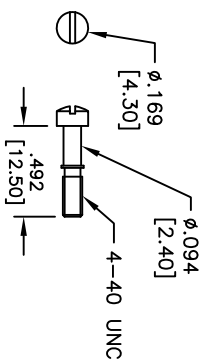
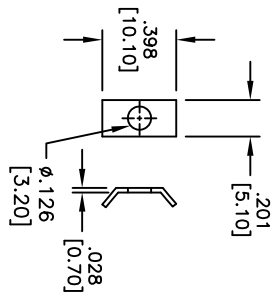
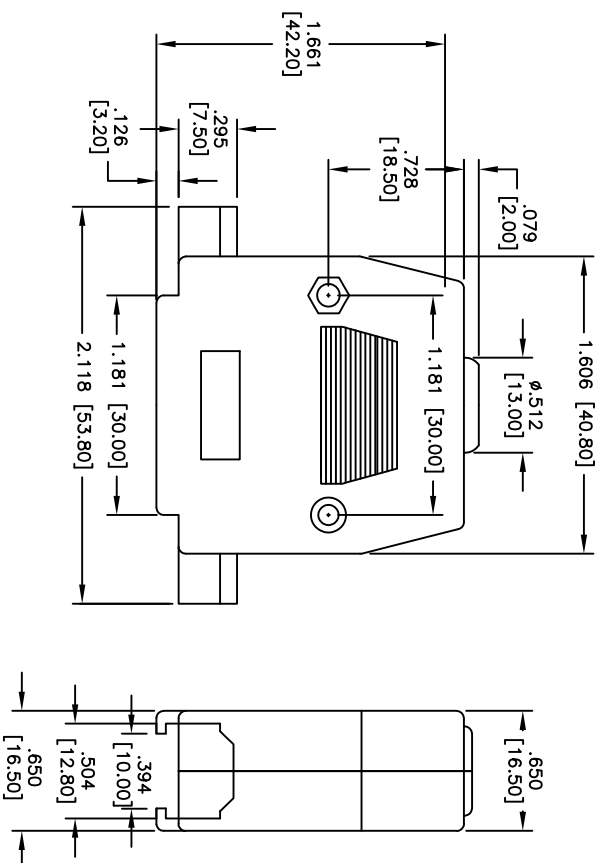
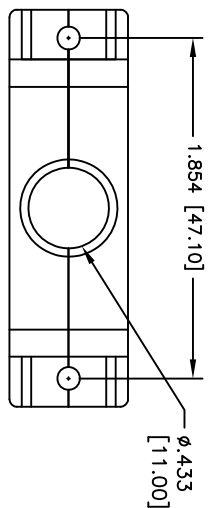

UNLESS OTHERWISE SPECIFIED  
 ALL DIMENSIONS ARE INCHES [MM]  
 TOLERANCES: EXCEPT AS NOTED  
 INCHES Holes ±.10  
 .X ±.10 ØXX ±.10  
 .XX ±.020 ØXXX ±.015  
 .XXX ±.015 ØXXXX ±.010

**ADAM TECH**  
 909 Railway Avenue, Union, NJ 07083  
 Phone: 908-687-5000 Fax: 908-687-5710

DRAWN		HR	5/22/15	SIZE	PART NO.	REV.
CHECKED		LL	5/22/15	X	DXXX-HD-PX-SS	-
APPROVALS		DATE		REF:	S000&T	SHEET 3 OF 5
TITLE		D-SUB HOOD, SHORT SCREWS				

6

5

4

3

2

1

6

5

4

3

2

1

Rev	AWC #	Description	Date	Appr
		SEE SHIT 1 OF 5 FOR REVISION		

APPROVED: \_\_\_\_\_

DATE: \_\_\_\_\_ TITLE: \_\_\_\_\_

# DC37--HD--PX--SS

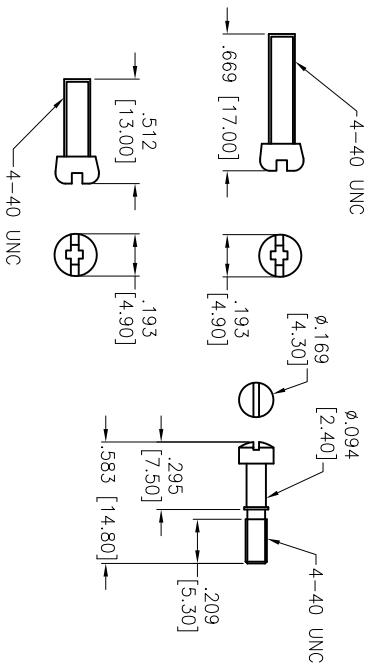
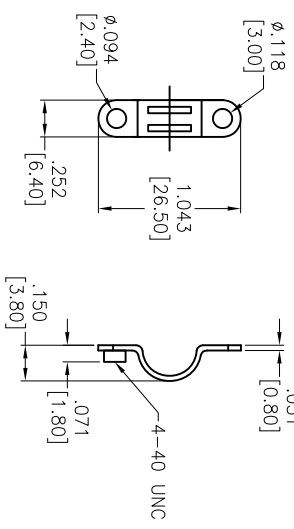
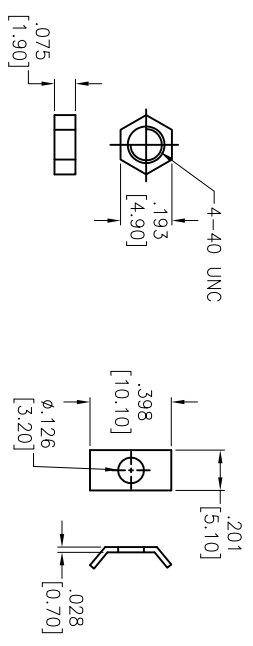
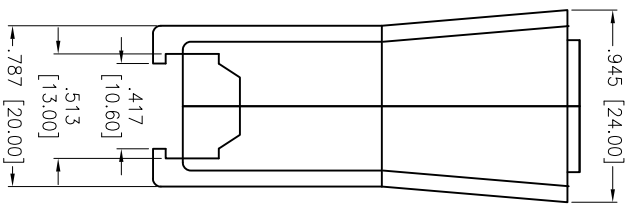
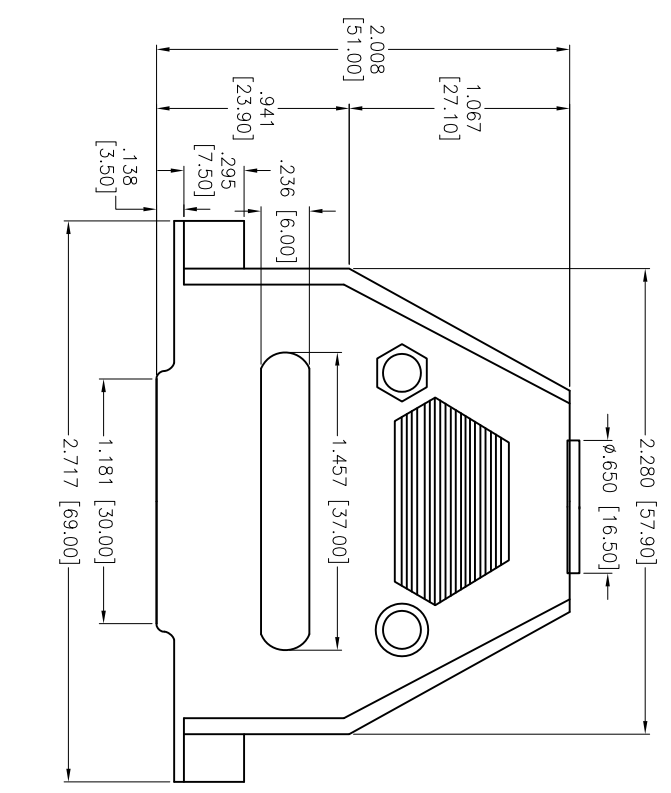
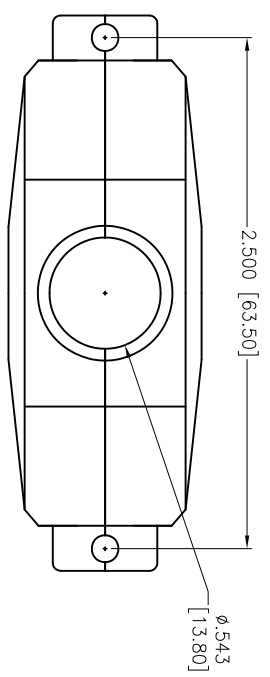

UNLESS OTHERWISE SPECIFIED  
ALL DIMENSIONS ARE IN INCHES [MM]  
TOLERANCES: EXCEPT AS NOTED

INCHES  
X ± .10  
.XX ± .020  
XXX ± .015

HOLES  
ØX ± .10  
ØXX ± .015  
ØXXX ± .010

APPROVALS

DRAWN	HR	5/22/15
CHECKED	LL	5/22/15
APPROVED		

**ADAM TECH**  
909 Railway Avenue, Union, NJ 07083  
Phone: 908-687-5000 Fax: 908-687-5710

## D-SUB HOOD, SHORT SCREWS

SIZE	PART NO.	REV.
X	DXXX-HD-PX-SS	-
REF:	S0002AT	SCALE: NTS
		SHEET 4 OF 5

6

5

4

3

2

1

6

5

4

3

2

1

Rev	AWO #	Description	Date	Appr
		SEE SHT 1 OF 5 FOR REVISION		

APPROVED: \_\_\_\_\_  
 DATE: \_\_\_\_\_ TITLE: \_\_\_\_\_

# DD50-HD-PX-SS

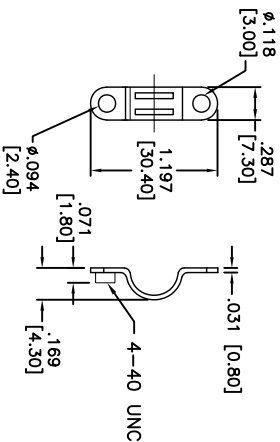
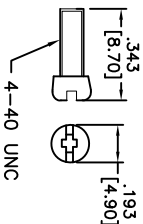
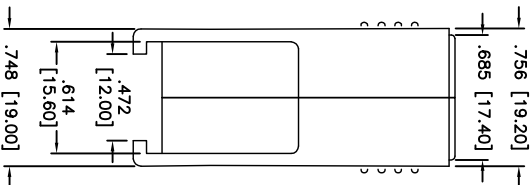
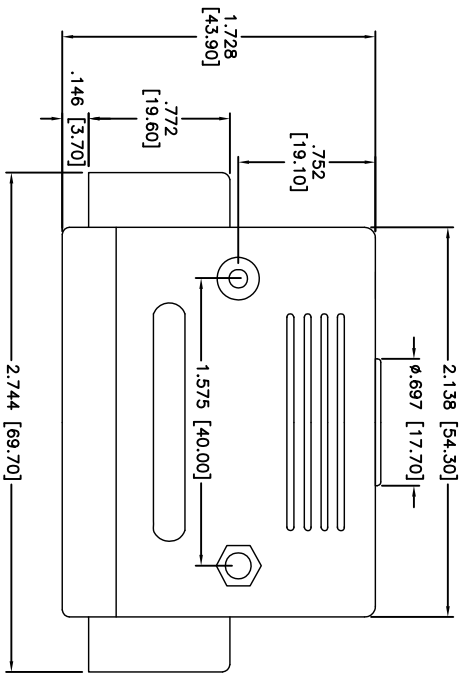
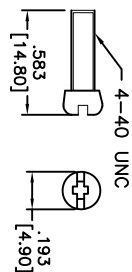
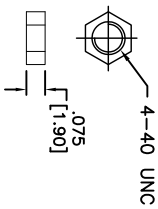
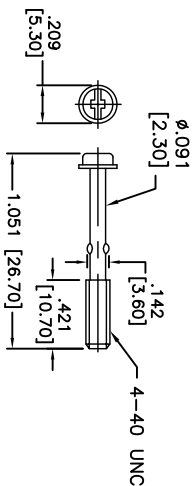
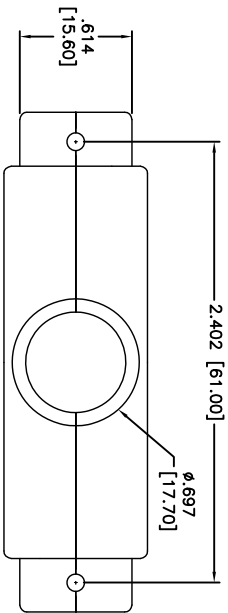

A

B

C

D

A

B

C

D

## ADAM TECH

909 Rahway Avenue, Union, NJ 07083  
 Phone: 908-687-5000 Fax: 908-687-5710

### D-SUB HOOD, SHORT SCREWS

UNLESS OTHERWISE SPECIFIED ALL DIMENSIONS ARE MM [INCHES] TOLERANCES: EXCEPT AS NOTED		TITLE	
INCHES	± .10	HOLES	± .10
Ø X	± .020	Ø XX	± .015
.XXX	± .015	Ø XXX	± .010
APPROVALS		DATE	
DRAWN	HR	5/22/15	
CHECKED	LL	5/22/15	
APPROVED			
SIZE	PART NO.	REV.	
X	DXXX-HD-PX-SS	-	
REF:	S00084T	SCALE:	NTS
		SHEET	5 OF 5

6

5

4

3

2

1