



Polymer Chip Capacitors

Basic

Series/Type: B760
Date: July 2006



© KEMET 2006. Reproduction, publication and dissemination of this publication, enclosures hereto and the information contained therein without KEMET's prior express consent is prohibited.

Basic

Features

- High volumetric efficiency
- Ultra-low ESR
- High permissible ripple current
- Only 20% derating recommended
- Stable temperature and frequency characteristics
- Operating temperature $-55 \dots +105 \text{ }^\circ\text{C}$
- No ignition failure mode
- Lead-free and material content compatible with RoHS
- Suitable for lead-free soldering
- Taped and reeled to IEC 60286-3



Dimensional drawing

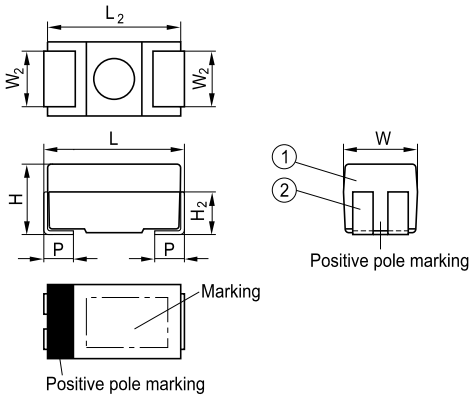

- ① Encapsulation: molded epoxy resin
- ② Cu-lead frame; tinned surface Sn 100

Basic

Dimensions

Case size		Dimensions in mm (inches)						
KEMET	EIA/IECQ	L	W	H	L ₂ typ.	W ₂ ±0.1 ±(.004)	H ₂ typ.	P ±0.3 ±(.012)
B	3528-21	3.5 ±0.2 (.138 ±0.008)	2.8 ±0.2 (.110 ±0.008)	1.9 ±0.1 (.075 ±0.008)	3.3 (.138)	2.2 (.087)	1.0 (.039)	0.8 (.031)
V	7343-20	7.3 ±0.3 (.287 ±0.012)	4.3 ±0.3 (.169 ±0.012)	1.9 ±0.1 (.075 ±0.004)	7.1 (.280)	2.4 (.094)	1.1 (.043)	1.3 (.051)
D	7343-31	7.3 ±0.3 (.287 ±0.012)	4.3 ±0.3 (.169 ±0.012)	2.8 ±0.3 (.110 ±0.012)	7.1 (.280)	2.4 (.094)	1.6 (.063)	1.3 (.051)

Basic

Marking

Case size B

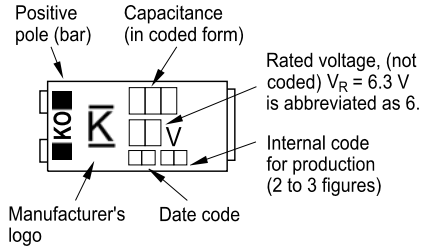

Case size D, V

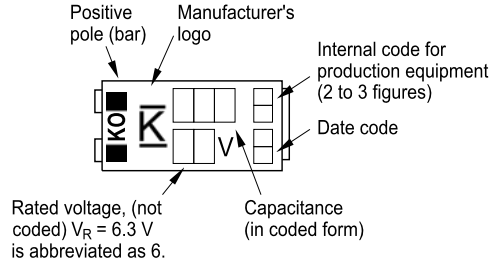

Capacitance coding

1st and 2nd digit	Capacitance in pF	
3rd digit	Multiplier:	6 = 10 ⁶ pF 7 = 10 ⁷ pF 8 = 10 ⁸ pF

Date coding

Year	Month	
S = 2004	1 = January	7 = July
T = 2005	2 = February	8 = August
U = 2006	3 = March	9 = September
V = 2007	4 = April	O = October
W = 2008	5 = May	N = November
X = 2009	6 = June	D = December

Specifications and characteristics in brief

Series		Basic	
Ordering code		B760	
Technology		Tantalum Polymer	
Terminals		Tinned	
Rated voltage (up to 85 °C)	V_R	2.5 ... 16	VDC
Rated capacitance (20 °C, 120 Hz)	C_R	47 - 470	μF
Capacitance tolerance	ΔC_R	± 20	%
Maximum equivalent series resistance (20 °C, 100 kHz)	ESR_{max}	12 ... 80	$\text{m}\Omega$
Operating temperature range	T_{op}	-55 ... +105	°C
Failure rate (at 40 °C; $\leq V_R$, 1 fit = $1 \cdot 10^{-9}$ failures/h) $R_S \leq 0.1 \Omega/\text{V}$		≤ 264	fit
Service life		>150000	h
Leakage current (V_R , 5 min, 20 °C)	I_{leak}	100	$\text{nA}/\mu\text{C}$
Climatic category (to IEC 60068-1) (-55 °C/+105 °C/56 days damp heat test)		55/105/56	
Moisture sensitivity level (MSL)		3	

Basic

Overview of types

(VDC) (up to 85 °C)	2.5	4	6.3	10	16
C_R (μF)					
33					
47					V(70)
68				V(45*...60*)	
100			D(45) V(35*...80)	D(55...80) V(25*...80)	
150			D(45...80) V(15*...80)		
220	D(45...55) V(15*...45)	D(45...55) V(15*...45)	D(40...50) V(25*...45*)		
330	D(40...55) V(12*...45*)	D(40...50) V(35*...45*)			
470	D(40) V(18*)	D(25*...60)			

() The ESR value (in mΩ) is stated in parentheses

Basic

Ordering code structure

B76	0	02	D	337	9	M	025
Ta Polymer							
Series 0 = Basic							
Rated voltage 02 = 2.5 V, 04 = 4 V, 06 = 6.3 V, 10 = 10 V, 16 = 16 V							
Case size B, D, V							
Rated capacitance + exponent C [pF] · 10 ^x 686 = 68 pF · 10 ⁶ = 68 μF, 157 = 15 pF · 10 ⁷ = 150 μF, 108 = 10 pF · 10 ⁸ = 1000 μF							
Reel diameter 9 = 180 mm, 6 = 330 mm							
Capacitance tolerance M = ±20%							
ESR value E.g.: 009 = 9 mΩ, 018 = 18 mΩ, 045 = 45 mΩ							

Basic

Technical data and ordering codes

C_R (20 °C, 120 Hz)	Case size	ESR_{max} (20 °C, 100 kHz)	DF_{max} (20 °C, 120 Hz)	$I_{leak,max}$ (20 °C, V_R , 5 min)	$I_{AC,max}$ (20 °C, 100 kHz)	$I_{AC,max}$ (85 °C, 100 kHz)	$I_{AC,max}$ (105 °C, 100 kHz)	Ordering code
μF		m Ω	%	μA	A	A	A	
V_R (up to 85 °C) = 2.5 VDC, V_R (up to 105 °C) = 2.0 VDC								
220	D	45	10	55	1.8	1.5	1.2	B76002D227*M045
220	D	55	10	55	1.7	1.3	1.0	B76002D227*M055
220	V	15	10	55	3.1	2.8	1.2	B76002V227*M015 ●
220	V	18	10	55	2.6	2.1	1.7	B76002V227*M018 ●
220	V	25	10	55	2.2	1.8	1.4	B76002V227*M025 ●
220	V	35	10	55	1.9	1.5	1.2	B76002V227*M035
220	V	45	10	55	1.7	1.3	1.1	B76002V227*M045
330	D	40	10	83	1.9	1.5	1.2	B76002D337*M040
330	D	55	10	83	1.7	1.3	1.0	B76002D337*M055
330	V	12	10	83	3.4	3.1	1.4	B76002V337*M012 ●
330	V	15	10	83	3.1	2.8	1.2	B76002V337*M015 ●
330	V	18	10	83	2.6	2.1	1.7	B76002V337*M018 ●
330	V	25	10	83	2.2	1.8	1.4	B76002V337*M025 ●
330	V	35	10	83	1.9	1.5	1.2	B76002V337*M035 ●
330	V	40	10	83	1.8	1.4	1.1	B76002V337*M040 ●
330	V	45	10	83	1.7	1.3	1.1	B76002V337*M045 ●
470	D	40	10	118	1.9	1.5	1.2	B76002D477*M040
470	V	18	10	118	2.6	2.1	1.7	B76002V477*M018 ●
V_R (up to 85 °C) = 4 VDC, V_R (up to 105 °C) = 3.2 VDC								
220	D	45	10	88	1.8	1.5	1.2	B76004D227*M045
220	D	55	10	88	1.7	1.3	1.0	B76004D227*M055
220	V	15	10	88	3.1	2.8	1.2	B76004V227*M012 ●
220	V	18	10	88	2.6	2.1	1.7	B76004V227*M018 ●
220	V	25	10	88	2.2	1.8	1.4	B76004V227*M025

● Preliminary Data

* = Code number for reel diameter

6 = 330-mm reel

9 = 180-mm reel

Basic

C_R (20 °C, 120 Hz)	Case size	ESR_{max} (20 °C, 100 kHz)	DF_{max} (20 °C, 120 Hz)	$I_{leak,max}$ (20 °C, V_R , 5 min)	$I_{AC,max}$ (20 °C, 100 kHz)	$I_{AC,max}$ (85 °C, 100 kHz)	$I_{AC,max}$ (105 °C, 100 kHz)	Ordering code
μF		m Ω	%	μA	A	A	A	
220	V	35	10	88	1.9	1.5	1.2	B76004V227*M035
220	V	40	10	88	1.8	1.4	1.1	B76004V227*M040
220	V	45	10	88	1.7	1.3	1.1	B76004V227*M045
330	D	40	10	132	1.9	1.5	1.2	B76004D337*M040
330	D	50	10	132	1.7	1.4	1.1	B76004D337*M050
330	V	35	10	132	1.9	1.5	1.2	B76004V337*M035 ●
330	V	45	10	132	1.7	1.3	1.1	B76004V337*M045 ●
470	D	25	10	188	2.5	2.2	1.0	B76004D477*M025 ●
470	D	40	10	188	1.9	1.5	1.2	B76004D477*M040
470	D	55	10	188	1.7	1.3	1.0	B76004D477*M055
470	D	60	10	188	1.6	1.3	1.0	B76004D477*M060
V_R (up to 85 °C) = 6.3 VDC, V_R (up to 105 °C) = 5.0 VDC								
100	D	45	10	63	1.8	1.5	1.2	B76006D107*M045
100	V	35	10	63	1.9	1.5	1.2	B76006V107*M035 ●
100	V	45	10	63	1.7	1.3	1.1	B76006V107*M045
100	V	80	10	63	1.3	1.1	0.5	B76006V107*M080
150	D	45	10	95	1.8	1.5	1.2	B76006D157*M045
150	D	55	10	95	1.7	1.3	1.0	B76006D157*M055
150	D	80	10	95	1.4	1.1	0.9	B76006D157*M080
150	V	15	10	95	2.9	2.6	1.2	B76006V157*M015 ●
150	V	18	10	95	2.6	2.1	1.7	B76006V157*M018 ●
150	V	25	10	95	2.2	1.8	1.4	B76006V157*M025
150	V	35	10	95	1.9	1.5	1.2	B76006V157*M035
150	V	40	10	95	1.8	1.4	1.1	B76006V157*M040
150	V	45	10	95	1.7	1.3	1.1	B76006V157*M045

● Preliminary Data

* = Code number for reel diameter

6 = 330-mm reel

9 = 180-mm reel

C_R (20 °C, 120 Hz)	Case size	ESR_{max} (20 °C, 100 kHz)	DF_{max} (20 °C, 120 Hz)	$I_{leak,max}$ (20 °C, V_R , 5 min)	$I_{AC,max}$ (20 °C, 100 kHz)	$I_{AC,max}$ (85 °C, 100 kHz)	$I_{AC,max}$ (105 °C, 100 kHz)	Ordering code
μF		m Ω	%	μA	A	A	A	
150	V	80	10	95	1.3	1.1	0.5	B76006V157*M080
220	D	40	10	139	1.9	1.5	1.2	B76006D227*M040
220	D	45	10	139	1.8	1.5	1.2	B76006D227*M045
220	D	50	10	139	1.7	1.4	1.1	B76006D227*M050
220	V	25	10	139	2.2	1.8	1.4	B76006V227*M025 ●
220	V	35	10	139	1.9	1.5	1.2	B76006V227*M035 ●
220	V	40	10	139	1.8	1.4	1.1	B76006V227*M040 ●
220	V	45	10	139	1.7	1.3	1.1	B76006V227*M045 ●
V_R (up to 85 °C) = 10 VDC, V_R (up to 105 °C) = 8.0 VDC								
68	V	45	10	68	1.7	1.3	1.1	B76010V686*M045 ●
68	V	60	10	68	1.4	1.3	0.6	B76010V686*M060 ●
100	D	55	10	100	1.7	1.3	1.0	B76010D107*M055
100	D	80	10	100	1.4	1.1	0.9	B76010D107*M080
100	V	25	10	100	2.2	1.8	1.4	B76010V107*M025 ●
100	V	40	10	100	1.8	1.4	1.1	B76010V107*M040
100	V	55	10	100	1.5	1.4	0.6	B76010V107*M055
100	V	80	10	100	1.3	1.1	0.5	B76010V107*M080
V_R (up to 85 °C) = 16 VDC, V_R (up to 105 °C) = 12.8 VDC								
47	V	70	10	75	1.3	1.2	0.5	B76016V476*M070

● Preliminary Data

* = Code number for reel diameter

6 = 330-mm reel

9 = 180-mm reel

Derating Recommendations, maximum continuous voltage

The maximum continuous voltage V_{cont} is the maximum permissible voltage at which the capacitor can be continuously operated. It is a direct current voltage, or the sum of the basic DC voltage plus the peak value of the superimposed AC voltage.

The maximum continuous voltage depends on the ambient temperature (see figure below). Within the temperature range of $-55\text{ }^{\circ}\text{C}$ to $+85\text{ }^{\circ}\text{C}$, the rated voltage is equal to the maximum continuous voltage.

In the temperature range between $+85$ and $105\text{ }^{\circ}\text{C}$ the maximum continuous voltage must be reduced linearly from the rated voltage to $4/5$ of the rated voltage (Derating). Operation below the maximum continuous voltage has a positive effect on the capacitor's reliability.

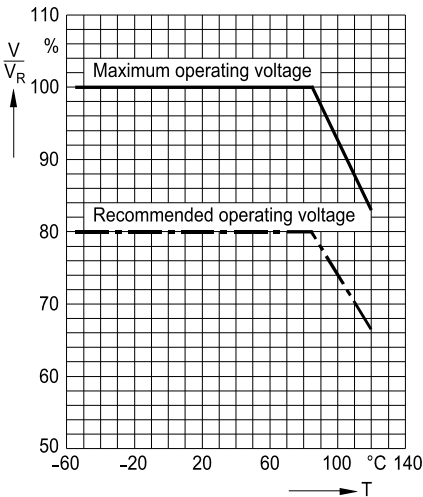

Max. permissible continuous voltage (operating voltage) versus temperature

Maximum permissible ripple current and alternating voltage loads

Using P_{max} from the following tables, the maximum permissible ripple current and alternating voltage loads can be calculated.

$$I_{max} = \sqrt{\frac{P_{max}}{ESR}} \qquad V_{max} = Z \sqrt{\frac{P_{max}}{ESR}}$$

Maximum permissible power dissipation with ripple current load

Case size	B	D	V
$P_{V,max}$ in mW	85	150	125

Reduction of the calculated values versus the ambient temperature, cf. figure below.

Permissible ripple current I_{AC} and permissible alternating voltage V_{AC} versus temperature T

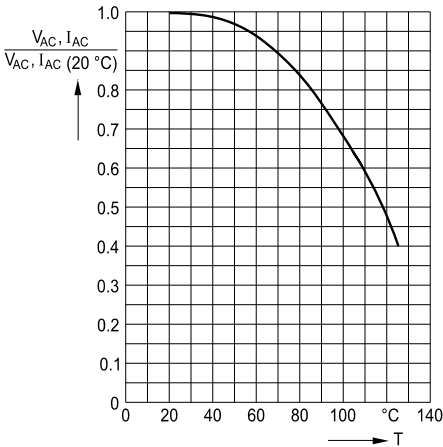

Permissible ripple current I_f versus frequency f

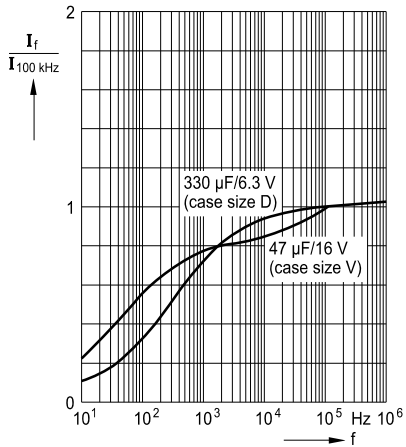

Temperature dependence of the capacitance

The capacitance of an electrolytic capacitor varies with the temperature (positive temperature coefficient). The amount by which it varies depends on the specific voltage and capacitance value.

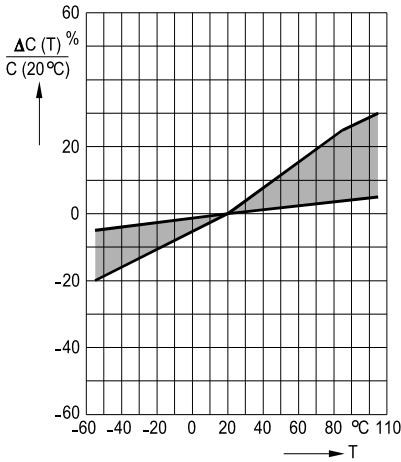

Capacitance change versus temperature (typ. values)

Capacitance change versus temperature (maximum values)

	- 55 °C	+ 85 °C	+ 105 °C
Basic	- 20%	+ 25%	+ 30%

Frequency dependence of the capacitance

The capacitance decreases with increasing frequency. A typical curve is shown.

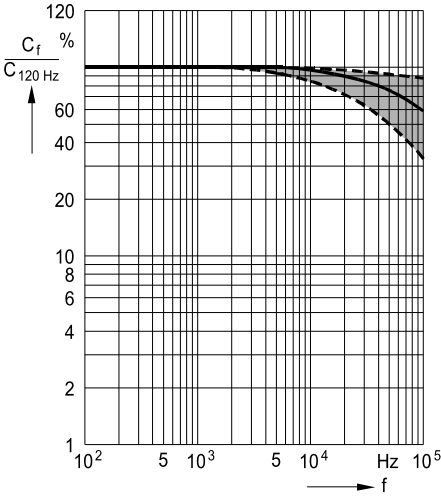

Capacitance change versus frequency (typical behaviour), reference temperature 20 °C

Temperature dependence of Z and ESR (typical behaviour)

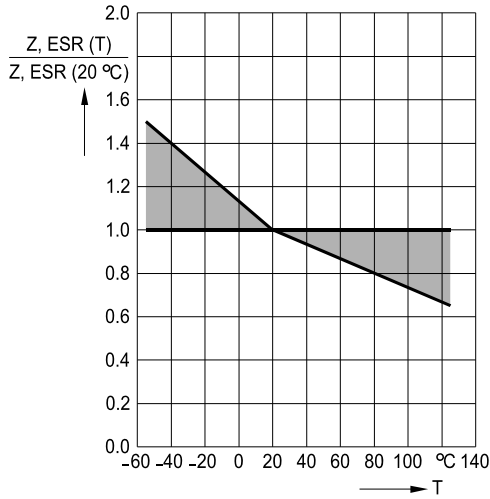

Polymer chip capacitors
Case sizes B, D, V

Frequency dependence of Z and ESR (typical behaviour)

Case size B

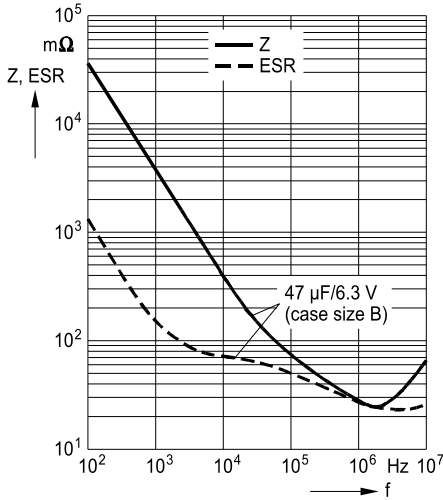

Case size D

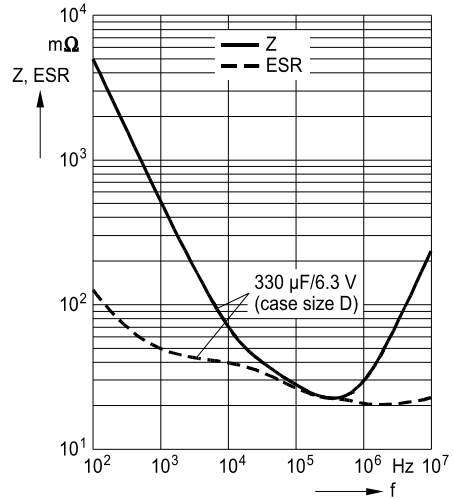

Case size V

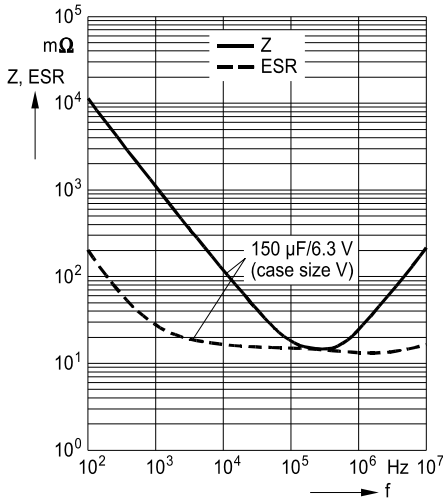

Dissipation factor

The dissipation factor $\tan \delta$ increases with frequency and tends to very high values at near-resonance frequencies. The figures below show the typical behaviour of the dissipation factor.

Dissipation factor versus temperature at $f = 120 \text{ Hz}$

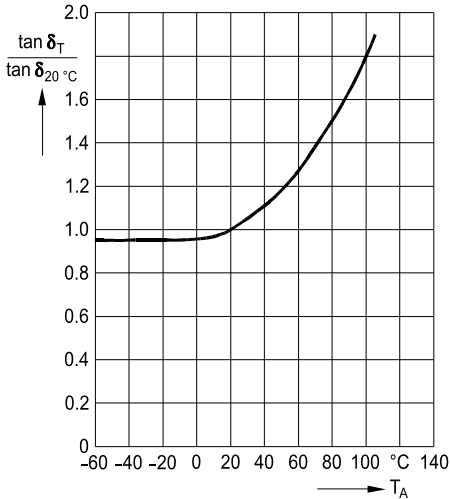

Dissipation factor versus frequency at $T = 20^\circ\text{C}$

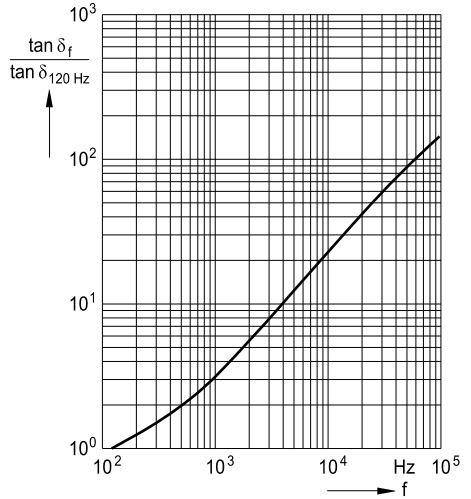

Leakage current

When a direct voltage is applied to electrolytic capacitors, a low, constant current will flow through any capacitor. This so-called leakage current I_{lk} is a function of the voltage as well as of the temperature. (Graphs are shown below).

The absolute value of the leakage current of an electrolytic capacitor is determined by defects of the dielectric. The (exclusive) usage of high-purity tantalum powder as raw material results in a low total amount of defects and thus in a low leakage current level.

Leakage current versus voltage

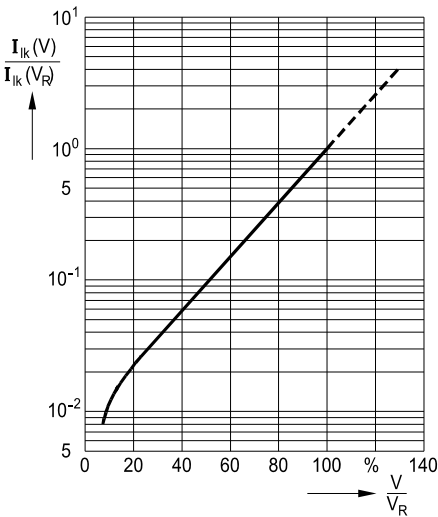

Leakage current versus temperature

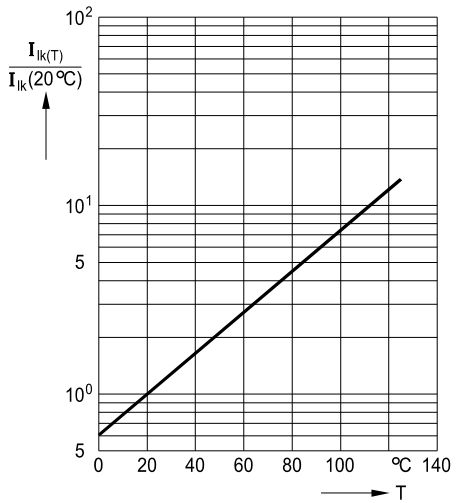

Infrared reflow soldering, hot air reflow soldering (lead-free solders alloys)

Temperature curve at component terminal in infrared and hot air soldering

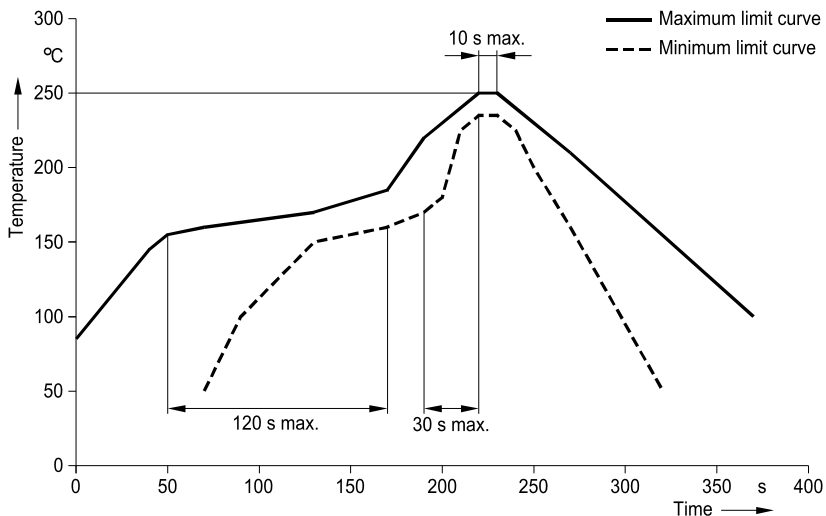

Other profiles and peak temperatures upon request.

Recommended solder pad layouts

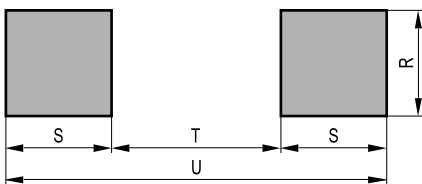

Dimensions (mm)

Case size	Soldering process	R	S	T	U
B	Wave soldering	2.7	2.0	1.5	5.5
	Reflow soldering	2.5	1.5	1.1	4.1
D, V	Wave soldering	2.9	2.9	4.4	10.2
	Reflow soldering	2.7	2.0	3.9	7.9

Basic

Taping

Chip capacitors are taped and reeled in accordance with IEC 60286-3. Sizes B is supplied in 8-mm blister tapes, sizes D and V in 12-mm blister tapes. The position of the positive pole (+) is shown in the dimensional drawing below.

Caution! If any capacitors are left over in the tape after placement, sparks may be generated when the tape is cut into pieces. This may impair or damage process equipment.

Tape dimensions and tolerances

Section A-A

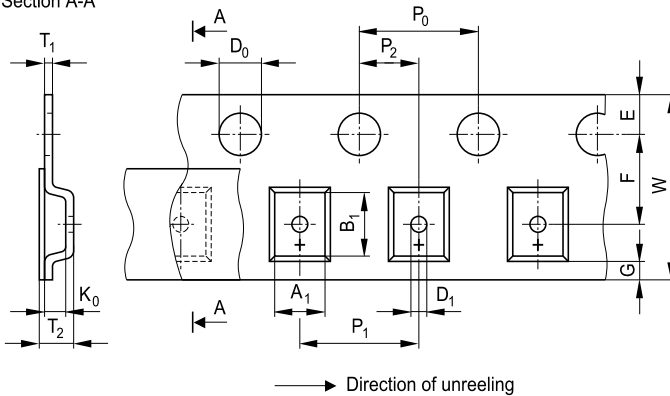

Dimensions (mm)	Case size					
	B	D	E	F	V	X
A ₁ ±0.2	3.3	4.7	4.7	4.7	4.7	4.7
B ₁ ±0.2	3.8	7.7	7.7	7.7	7.7	7.7
D ₀ +0.1/-0	1.5	1.5	1.5	1.5	1.5	1.5
D ₁ min.	1.0	1.5	1.5	1.5	1.5	1.5
P ₀ ±0.1 ¹⁾	4.0	4.0	4.0	4.0	4.0	4.0
P ₁ ±0.1	4.0	8.0	8.0	8.0	8.0	8.0
P ₂ ±0.05	2.0	2.0	2.0	2.0	2.0	2.0
W ±0.3	8.0	12.0	12.0	12.0	12.0	12.0
E ±0.1	1.75	1.75	1.75	1.75	1.75	1.75
F ±0.05	3.5	5.5	5.5	5.5	5.5	5.5
G min.	0.75	0.75	0.75	0.75	0.75	0.75
T ₁ ±0.05	0.25	0.3	0.3	0.25	0.3	0.3
T ₂ max.	2.6	3.6	4.8	4.5	2.75	2.45
K ₀ ±0.1	2.2	3.3	4.6	4.2	2.3	1.8

1) 0.2 mm over 10 sprocket hole spaces.

Basic

Packing

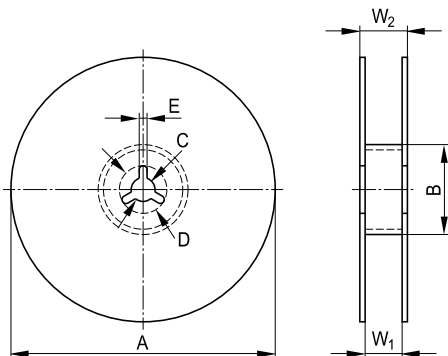

Packing of the reels in drypack upon request.

Dimensions (mm)

	Reel	
	180 mm diameter	330 mm diameter
A	180 -3	300 ±2
B	60.0 +1/-0	60.0 +2/-0
C	13.0 ±0.2	13.0 ±0.2
D	21.0 ±0.4	21.0 ±0.8
E	2.0 ±0.1	2.0 ±0.15
W ₁ (8-mm tape)	9.0 ±0.3	8.5 +1/-0
(12-mm tape)	13.0 ±0.3	12.5 +1/-0
W ₂ (8-mm tape)	11.4 ±1	12.5 +1.2/-0.2
(12-mm tape)	15.4 ±1	16.5 +1.2/-0.2

Packing units and weights

Case size	Reel: taped; 180 mm diameter pieces/reel	Reel: taped; 330 mm diameter pieces/reel	Approx. weight per capacitor g ²⁾
B	2000	8000	0.07
D	750	2800	0.30
V	1000	3750	0.25

2) Guideline values, possible deviations of up to approximately ±30%.

Test limits for polymer chip capacitors

Endurance 2000 h at +85 °C, V_R 2000 h at +105 °C, $4/5 V_R$	Capacitance change: $\pm 20\%$ of initial measured value Dissipation factor: $< 150\%$ of initial specified value Leakage current (DC): $< 300\%$ of initial specified value
Damp heat, steady state to IEC 60068-2-3	Severity 3: 40 (± 2) °C 93 (+2/-3) % relative humidity Duration: 21 days $ \Delta C/C $ $\leq 40\%$, -20% of initial measured value $\tan \delta$ $\leq 1.5 \cdot$ initial limit value $I_{IK,20^\circ C}$ $\leq 300\%$ of initial limit value
Vibration Test Fc to IEC 60068-2-6	Frequency range: 10 ... 2000 Hz Amplitude: 1.5 mm (max 196 m/s ² , i.e. 20 g) Test duration: 6 h
Shock Test Ea to 60068-2-27	Peak load: 981 m/s ² , i.e. 100 g
Shear test Ue3 to IEC 60068-2-21	Force: 5 N for 10 (± 1) s

Storage conditions

KEMET polymer capacitors are shipped in moisture barrier bags together with a desiccant and a moisture indicator card.

All series (B760, B761, B763) are classified according JEDEC J-STD-020C as MSL 3 (Moisture Sensitivity Level 3). Parts should be mounted 168 hours (= 7 days) after opening the moisture barrier bags to prevent absorption of moisture and outgassing effects during soldering. Following rules should be adhered to:

- Parts must be stored in the reel and sealed moisture barrier bag until usage.
- Parts should not be stored at high temperature, high humidity, corrosive atmospheres and exposed to direct sun light. To enable the floor life of 168 hours according JEDEC J-STD-033A a maximum temperature of 30 °C at a humidity of maximum 60% R.H. is required.
- Temperature fluctuation should be minimized.

Environmental comments and warnings

As a manufacturer of passive components, we develop our products on the basis of the relevant standards and laws, and thus ensure that our products are free of those materials and substances prohibited by the relevant legislation.

To ensure a standardized procedure for KEMET worldwide, a binding list of materials and substances is included in our environment management system to ISO 14001. Our planning and development guidelines include regulations and directives aiming to promote recognition of environmental aspects and to optimize products and processes in terms of material use and environmental compatibility, to design them with a sparing use of resources and to replace hazardous substances as far as possible.

The environmental officer provides support in assessing the environmental risks of a development project upon request. Consideration of environmental aspects is checked and recorded at the design reviews.

Cautions and warnings

When using polymer capacitors, the following cautions and warnings should be taken into account:

Polarity

Because polymer capacitors are polar capacitors, it is important to observe their polarity markings (positive pole on the anode, negative pole on the cathode). Any incorrect polarity resulting from the sum of the AC and DC voltage components must be smaller than or equal to the permitted polarity reversal voltage. To avoid reducing their reliability, this voltage may only occur for a short time, at most five times for a total duration of one minute per hour.

Voltage

The maximum continuous voltage depends on the ambient temperature. Within the temperature range of -55 to +85 °C, the rated voltage is equal to the maximum continuous voltage. Between +85 and +105 °C the maximum continuous voltage must be reduced linearly from the full rated voltage to 4/5 of it (derating at 105 °C). Operation below the maximum continuous voltage has a positive effect on the capacitor's life time reliability. The maximum continuous voltage must not be exceeded.

All unfavourable operating conditions (such as possible line overvoltages, unfavourable tolerances of the transformation ratio of the line transformer in the equipment, repeated overvoltages when the equipment is switched on/off, high ambient temperatures) must be taken into account when determining the operating voltage.

The surge voltage is the maximum voltage (peak value) that may be applied to the capacitor for short periods, at most five times for a total duration of up to 1 minute per hour (high charge/discharge current conditions are not allowed above rated voltage). The surge voltage must not be applied for periodic charging and discharging in the course of normal operation and cannot be part of the operating voltage. The permissible surge voltage for all capacitors in this data book is 1.3 x the rated voltage up to 85 °C (4/5 of the rated voltage for 85 °C up to 105 °C). The occurrence of voltage impulses (transient voltages) that exceed the surge voltage may lead to irreparable damage.

Capacitance

The actual capacitance of a capacitor can deviate from the rated capacitance by as much as the full magnitude of the tolerance at delivery. Capacitance generally varies with temperature (at +85 °C up to +20%) and frequency.

Low-resistance applications and voltage networks

For low-resistance applications, KEMET recommends a maximum operating voltage of half the permissible maximum continuous voltage, so that the capacitors have sufficient tolerance to withstand voltage peaks. Depending on the conditions of use, the early failure rate is maybe higher here by a factor of 2 to 20 than in the range with a constant failure rate as specified in the data book.

When operated directly in a voltage network, the capacitor should be protected against overvoltage, e.g. by a suppressor diode, and against polarity reversal by a diode. If a capacitor is operated in an unprotected low-impedance circuit and fails because the permissible conditions for the forward DC voltage, reverse DC voltage, power dissipation or temperature are exceeded, the continued current flow through the overstressed capacitor may produce overheating. The overheated capacitor may damage the surrounding components and the circuit board.

Important notes

The following applies to all products named in this publication:

1. Some parts of this publication contain **statements about the suitability of our products for certain areas of application**. These statements are based on our knowledge of typical requirements that are often placed on our products in the areas of application concerned. We nevertheless expressly point out **that such statements cannot be regarded as binding statements about the suitability of our products for a particular customer application**. As a rule, KEMET is either unfamiliar with individual customer applications or less familiar with them than the customers themselves. For these reasons, it is always ultimately incumbent on the customer to check and decide whether a KEMET product with the properties described in the product specification is suitable for use in a particular customer application.
2. We also point out that **in individual cases, a malfunction of passive electronic components or failure before the end of their usual service life cannot be completely ruled out in the current state of the art, even if they are operated as specified**. In customer applications requiring a very high level of operational safety and especially in customer applications in which the malfunction or failure of a passive electronic component could endanger human life or health (e.g. in accident prevention or life-saving systems), it must therefore be ensured by means of suitable design of the customer application or other action taken by the customer (e.g. installation of protective circuitry or redundancy) that no injury or damage is sustained by third parties in the event of malfunction or failure of a passive electronic component.
3. **The warnings, cautions and product-specific notes must be observed.**
4. In order to satisfy certain technical requirements, **some of the products described in this publication may contain substances subject to restrictions in certain jurisdictions (e.g. because they are classed as “hazardous”)**. Should you have any more detailed questions, please contact our sales offices.
5. We constantly strive to improve our products. Consequently, **the products described in this publication may change from time to time**. The same is true of the corresponding product specifications. Please check therefore to what extent product descriptions and specifications contained in this publication are still applicable before or when you place an order.
We also **reserve the right to discontinue production and delivery of products**. Consequently, we cannot guarantee that all products named in this publication will always be available.
6. Unless otherwise agreed in individual contracts, **all orders are subject to the current version of the “General Terms of Delivery for Products and Services in the Electrical Industry” published by the German Electrical and Electronics Industry Association (ZVEI)**.