

1-104482-3 ✓ ACTIVE

AMPMODU | AMPMODU IV/V

TE Internal #: 1-104482-3

Housing, Receptacle, Wire-to-Board, 30 Position, .1 in [2.54 mm]

Centerline, Crimp, 2 Row, Black, Wire & Cable, Signal, AMPMODU IV/V

[View on TE.com >](#)



Connectors > PCB Connectors > Wire-to-Board Connectors > Wire-to-Board Connector Assemblies & Housings



Connector Product Type: **Housing**

Connector & Housing Type: **Receptacle**

Connector System: **Wire-to-Board**

Number of Positions: **30**

Centerline (Pitch): **2.54 mm [.1 in]**

Features

Product Type Features

Connector Product Type	Housing
Connector & Housing Type	Receptacle
Connector System	Wire-to-Board
Connector & Contact Terminates To	Wire & Cable

Configuration Features

Number of Positions	30
Number of Rows	2

Electrical Characteristics

Termination Resistance	12 mΩ
Insulation Resistance	5000 MΩ
Dielectric Withstanding Voltage (Max)	750 V
Operating Voltage	300 VAC

Body Features

Primary Product Color	Black
-----------------------	-------

Contact Features

Contact Type	Socket
Contact Current Rating (Max)	3 A

Termination Features



Termination Method to Wire & Cable	Crimp
------------------------------------	-------

Mechanical Attachment

Strain Relief	Without
Panel Mount Feature	Without
PCB Mount Retention	Without
Mating Retention	Without

Housing Features

Housing Entry Configuration	Both Ends Closed
Housing Material	Thermoplastic
Centerline (Pitch)	2.54 mm[.1 in]

Dimensions

	.198 in
Wire Size	.03 – .6 mm ²
Row-to-Row Spacing	2.54 mm[.1 in]

Usage Conditions

Operating Temperature Range	-65 – 105 °C[-85 – 221 °F]
-----------------------------	----------------------------

Operation/Application

Circuit Application	Signal
---------------------	--------

Industry Standards

Approved Standards	CSA LR7189, UL E28476
UL Flammability Rating	UL 94V-0

Packaging Features

Packaging Quantity	1
Packaging Method	Package

Product Compliance

[For compliance documentation, visit the product page on TE.com>](#)

EU RoHS Directive 2011/65/EU	Compliant
EU ELV Directive 2000/53/EC	Compliant
China RoHS 2 Directive MIIT Order No 32, 2016	No Restricted Materials Above Threshold
EU REACH Regulation (EC) No. 1907/2006	Current ECHA Candidate List: JUNE 2023 (235)



Candidate List Declared Against: JAN 2023
(233)

Does not contain REACH SVHC

Halogen Content

BFR/CFR/PVC Free, but Br/Cl >900 ppm in other sources.

Solder Process Capability

Not applicable for solder process capability

Product Compliance Disclaimer

This information is provided based on reasonable inquiry of our suppliers and represents our current actual knowledge based on the information they provided. This information is subject to change. The part numbers that TE has identified as EU RoHS compliant have a maximum concentration of 0.1% by weight in homogenous materials for lead, hexavalent chromium, mercury, PBB, PBDE, DBP, BBP, DEHP, DIBP, and 0.01% for cadmium, or qualify for an exemption to these limits as defined in the Annexes of Directive 2011/65/EU (RoHS2). Finished electrical and electronic equipment products will be CE marked as required by Directive 2011/65/EU. Components may not be CE marked. Additionally, the part numbers that TE has identified as EU ELV compliant have a maximum concentration of 0.1% by weight in homogenous materials for lead, hexavalent chromium, and mercury, and 0.01% for cadmium, or qualify for an exemption to these limits as defined in the Annexes of Directive 2000/53/EC (ELV). Regarding the REACH Regulation, the information TE provides on SVHC in articles for this part number is based on the latest European Chemicals Agency (ECHA) 'Guidance on requirements for substances in articles' posted at this URL: <https://echa.europa.eu/guidance-documents/guidance-on-reach>

Compatible Parts

TE Part # 1-104479-0
SHORT POINT CONT 30 DPLX STMPD LF

TE Part # 104479-9
SHORT POINT CONT 15 DPLX STMPD LF

TE Part # 1-104480-7
SHORT POINT CONT PLTD SN

TE Part # 104480-4
SHORT POINT CONT 30 DPLX STMPD LF

TE Part # 1-104480-3
SHORT POINT CONT 30 DPLX STMPD LF

TE Part # 104479-8
SHORT POINT CONT PLTD SN

TE Part # 1-104480-2
SHORT POINT CONT 15 DPLX STMPD LF

TE Part # 104480-2
SHORT POINT CONT PLTD SN-PB

TE Part # 1-104481-1
SHORT POINT CONT 30 DPLX STMPD LF

TE Part # 1-104481-0
SHORT POINT CONT 15 DPLX STMPD LF

TE Part # 104479-2
SHORT POINT CONT PLTD SN-PB

Also in the Series | AMPMODU IV/V

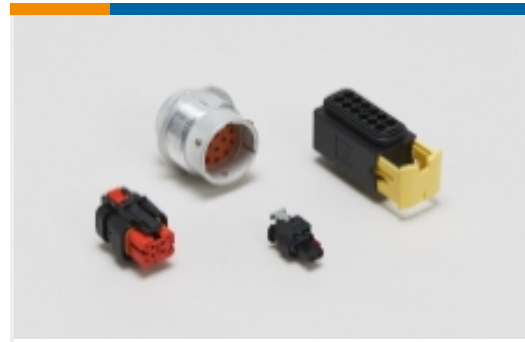

Automotive Housings(2)

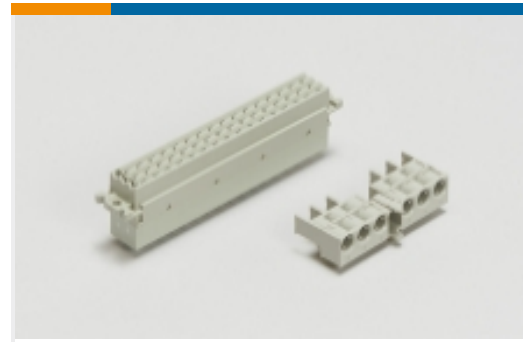

Backplane Connector Housings(1)



Board-to-Board Connector Contacts(6)



Insertion & Extraction Tools(4)

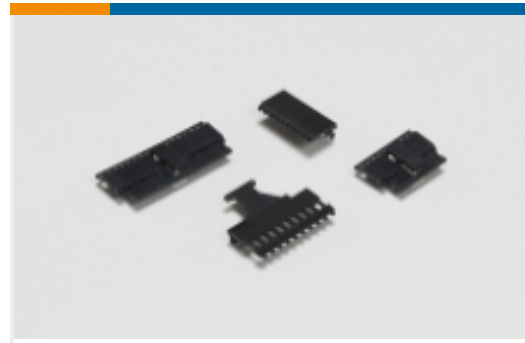

PCB Connector Covers(18)



PCB Connector Keying(6)



PCB Connector Mounting(1)

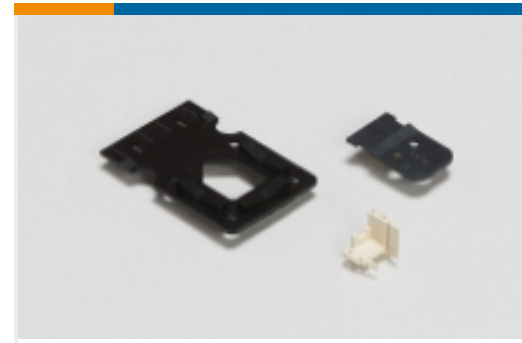

PCB Connector Strain Relief(3)

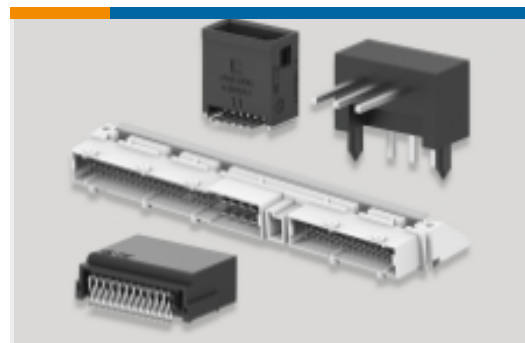

PCB Headers & Receptacles(934)



PCB Latches, Locks & Retainers(7)



Rectangular Connector Housings(5)



Standard Rectangular Connectors(8)

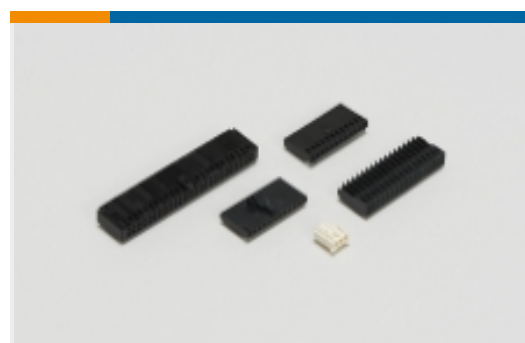

Wire-to-Board Connector Assemblies & Housings(447)



Wire-to-Board Connector Contacts (322)

Customers Also Bought



TE Part #1375820-6
Receptacle Housing: 2.54mm, 1 Row, CST-100 II



TE Part #1-66100-9
III+ SKT,18-16,TIN ,STRIP



TE Part #86286-1
KEYING PLUG



TE Part #66098-7
III+ PIN,18-16,TIN-LEAD,STRIP

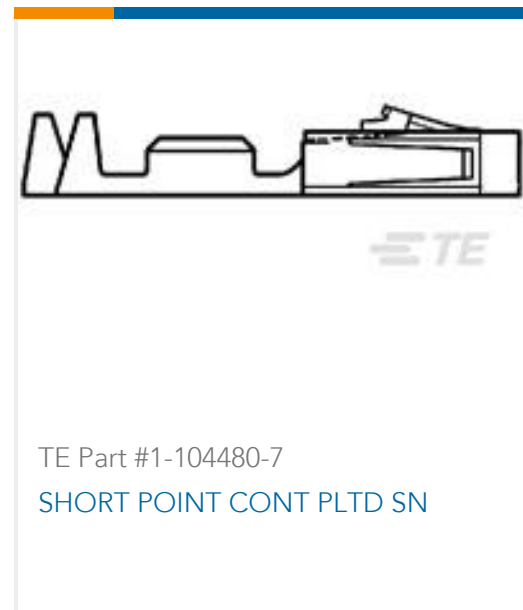

Documents

Product Drawings

[30 SHORT PT RCPT HSG DR .100CL](#)

English

CAD Files

[3D PDF](#)

3D

Customer View Model

[ENG_CVM_CVM_1-104482-3_H.2d_dxf.zip](#)

English

Customer View Model

[ENG_CVM_CVM_1-104482-3_H.3d_igs.zip](#)

English

Customer View Model

[ENG_CVM_CVM_1-104482-3_H.3d_stp.zip](#)

English

By downloading the CAD file I accept and agree to the [Terms and Conditions](#) of use.

Datasheets & Catalog Pages

[AMPMODU_INTERCONNECTION_SYSTEM_SECTION5_CONT](#)

English

Product Specifications

[Application Specification](#)

English

Agency Approvals

[UL](#)

1-104482-3

Housing, Receptacle, Wire-to-Board, 30 Position, .1 in [2.54 mm] Centerline, Crimp, 2 Row, Black, Wire & Cable, Signal, AMPMODU IV/V



English