

IGBT

IGBT with integrated diode in packages offering space saving advantage

IKD15N60R, IKU15N60R

600V TRENCHSTOP™ RC-Series for hard switching applications

Datasheet

Industrial & Multimarket

IGBT with integrated diode in packages offering space saving advantage

Features:

TRENCHSTOP™ Reverse Conducting (RC) technology for 600V applications offering

- Optimised V_{CEsat} and V_F for low conduction losses
- Smooth switching performance leading to low EMI levels
- Very tight parameter distribution
- Operating range of 1 to 20kHz
- Maximum junction temperature 175°C
- Short circuit capability of 5μs
- Best in class current versus package size performance
- Qualified according to JEDEC for target applications
- Pb-free lead plating; RoHS compliant (for PG-TO252: solder temperature 260°C, MSL1)
- Complete product spectrum and PSpice Models:
<http://www.infineon.com/igbt/>

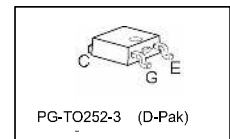
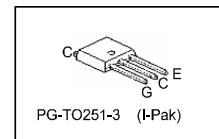
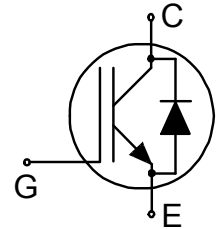

Applications:

- Consumer motor drives



Key Performance and Package Parameters

Type	V_{CE}	I_C	$V_{CEsat}, T_{vj}=25^\circ\text{C}$	T_{vjmax}	Marking	Package
IKD15N60R	600V	15A	1.65V	175°C	K15R60	PG-TO252-3
IKU15N60R	600V	15A	1.65V	175°C	K15R60	PG-TO251-3



Table of Contents

Description 2

Table of Contents 3

Maximum ratings 4

Thermal Resistance 4

Electrical Characteristics 5

Electrical Characteristics diagrams 8

Package Drawing PG-TO252-315

Package Drawing PG-TO251-316

Testing Conditions17

Revision History18

Disclaimer18

Maximum ratings

Parameter	Symbol	Value	Unit
Collector-emitter voltage	V_{CE}	600	V
DC collector current, limited by T_{vjmax} $T_C = 25^\circ\text{C}$ $T_C = 100^\circ\text{C}$	I_C	30.0 15.0	A
Pulsed collector current, t_p limited by T_{vjmax}	I_{Cpuls}	45.0	A
Turn off safe operating area $V_{CE} \leq 600\text{V}$, $T_{vj} \leq 175^\circ\text{C}$	-	45.0	A
Diode forward current, limited by T_{vjmax} $T_C = 25^\circ\text{C}$ $T_C = 100^\circ\text{C}$	I_F	30.0 15.0	A
Diode pulsed current, t_p limited by T_{vjmax}	I_{Fpuls}	45.0	A
Gate-emitter voltage	V_{GE}	± 20	V
Short circuit withstand time $V_{GE} = 15.0\text{V}$, $V_{CC} \leq 400\text{V}$ Allowed number of short circuits < 1000 Time between short circuits: $\geq 1.0\text{s}$ $T_{vj} = 150^\circ\text{C}$	t_{SC}	5	μs
Power dissipation $T_C = 25^\circ\text{C}$	P_{tot}	250.0	W
Operating junction temperature	T_{vj}	-40...+175	$^\circ\text{C}$
Storage temperature	T_{stg}	-55...+175	$^\circ\text{C}$
Soldering temperature, wave soldering 1.6 mm (0.063 in.) from case for 10s	PG-TO251-3	260	$^\circ\text{C}$
reflow soldering (MSL1 according to JEDEC J-STA-020)	PG-TO252-3	260	

Thermal Resistance

Parameter	Symbol	Conditions	Max. Value	Unit
Characteristic				
IGBT thermal resistance, ¹⁾ junction - case	$R_{th(j-c)}$		0.60	K/W
Diode thermal resistance, ²⁾ junction - case	$R_{th(j-c)}$		2.00	K/W
Thermal resistance, min. footprint junction - ambient	$R_{th(j-a)}$	PG-TO252-3	75	K/W
Thermal resistance, 6cm ² Cu on PCB junction - ambient	$R_{th(j-a)}$	PG-TO252-3	50	K/W
Thermal resistance junction - ambient	$R_{th(j-a)}$	PG-TO251-3	75	K/W

¹⁾ Rth/Zth based on single cooling pulse. Please be aware that a correct Rth measurement of the IGBT, is not possible using a thermocouple.

²⁾ Rth/Zth based on single cooling pulse. Please be aware that a correct Rth measurement of the Diode, is not possible using a thermocouple.

Electrical Characteristic, at $T_{vj} = 25^{\circ}\text{C}$, unless otherwise specified

Parameter	Symbol	Conditions	Value			Unit
			min.	typ.	max.	
Static Characteristic						
Collector-emitter breakdown voltage	$V_{(BR)CES}$	$V_{GE} = 0\text{V}, I_C = 0.20\text{mA}$	600	-	-	V
Collector-emitter saturation voltage	V_{CEsat}	$V_{GE} = 15.0\text{V}, I_C = 15.0\text{A}$ $T_{vj} = 25^{\circ}\text{C}$ $T_{vj} = 175^{\circ}\text{C}$	- -	1.65 1.85	2.10 -	V
Diode forward voltage	V_F	$V_{GE} = 0\text{V}, I_F = 15.0\text{A}$ $T_{vj} = 25^{\circ}\text{C}$ $T_{vj} = 175^{\circ}\text{C}$	- -	1.70 1.70	2.10	V
Gate-emitter threshold voltage	$V_{GE(th)}$	$I_C = 0.25\text{mA}, V_{CE} = V_{GE}$	4.3	5.0	5.7	V
Zero gate voltage collector current ¹⁾	I_{CES}	$V_{CE} = 600\text{V}, V_{GE} = 0\text{V}$ $T_{vj} = 25^{\circ}\text{C}$ $T_{vj} = 175^{\circ}\text{C}$	- -	- -	40.0 1000.0	μA
Gate-emitter leakage current	I_{GES}	$V_{CE} = 0\text{V}, V_{GE} = 20\text{V}$	-	-	100	nA
Transconductance	g_{fs}	$V_{CE} = 20\text{V}, I_C = 15.0\text{A}$	-	9.4	-	S
Integrated gate resistor	r_G			none		Ω

Electrical Characteristic, at $T_{vj} = 25^{\circ}\text{C}$, unless otherwise specified

Parameter	Symbol	Conditions	Value			Unit
			min.	typ.	max.	
Dynamic Characteristic						
Input capacitance	C_{ies}	$V_{CE} = 25\text{V}, V_{GE} = 0\text{V}, f = 1\text{MHz}$	-	961	-	pF
Output capacitance	C_{oes}		-	53	-	
Reverse transfer capacitance	C_{res}		-	33	-	
Gate charge	Q_G	$V_{CC} = 480\text{V}, I_C = 15.0\text{A},$ $V_{GE} = 15\text{V}$	-	90.0	-	nC
Internal emitter inductance measured 5mm (0.197 in.) from case	L_E	PG-TO252-3 PG-TO251-3	-	- 7.0	-	nH
Short circuit collector current Max. 1000 short circuits Time between short circuits: $\geq 1.0\text{s}$	$I_{C(SC)}$	$V_{GE} = 15.0\text{V}, V_{CC} \leq 400\text{V},$ $t_{SC} \leq 5\mu\text{s}$ $T_{vj} = 25^{\circ}\text{C}$	-	112	-	A

¹⁾ Not subject to production test - verified by design/characterization

Switching Characteristic, Inductive Load, at $T_{vj} = 25^{\circ}\text{C}$

Parameter	Symbol	Conditions	Value			Unit
			min.	typ.	max.	
IGBT Characteristic						
Turn-on delay time	$t_{d(on)}$	$T_{vj} = 25^{\circ}\text{C}$, $V_{CC} = 400\text{V}$, $I_C = 15.0\text{A}$, $V_{GE} = 0.0/15.0\text{V}$, $r_G = 15.0\Omega$, $L_{\sigma} = 60\text{nH}$, $C_{\sigma} = 40\text{pF}$ L_{σ} , C_{σ} from Fig. E	-	16	-	ns
Rise time	t_r		-	10	-	ns
Turn-off delay time	$t_{d(off)}$		-	183	-	ns
Fall time	t_f		-	136	-	ns
Turn-on energy	E_{on}		-	0.37	-	mJ
Turn-off energy	E_{off}		-	0.53	-	mJ
Total switching energy	E_{ts}		-	0.90	-	mJ

Diode Characteristic, at $T_{vj} = 25^{\circ}\text{C}$

Diode reverse recovery time	t_{rr}	$T_{vj} = 25^{\circ}\text{C}$, $V_R = 400\text{V}$, $I_F = 15.0\text{A}$, $di_F/dt = 1300\text{A}/\mu\text{s}$	-	110	-	ns
Diode reverse recovery charge	Q_{rr}		-	0.76	-	μC
Diode peak reverse recovery current	I_{rrm}		-	20.5	-	A
Diode peak rate of fall of reverse recovery current during t_b	di_{rr}/dt		-	-1640	-	$\text{A}/\mu\text{s}$

Switching Characteristic, Inductive Load, at $T_{vj} = 175^{\circ}\text{C}$

Parameter	Symbol	Conditions	Value			Unit
			min.	typ.	max.	
IGBT Characteristic						
Turn-on delay time	$t_{d(on)}$	$T_{vj} = 175^{\circ}\text{C}$, $V_{CC} = 400\text{V}$, $I_C = 15.0\text{A}$, $V_{GE} = 0.0/15.0\text{V}$, $r_G = 15.0\Omega$, $L_{\sigma} = 60\text{nH}$, $C_{\sigma} = 40\text{pF}$ L_{σ} , C_{σ} from Fig. E	-	15	-	ns
Rise time	t_r		-	11	-	ns
Turn-off delay time	$t_{d(off)}$		-	212	-	ns
Fall time	t_f		-	218	-	ns
Turn-on energy	E_{on}		-	0.41	-	mJ
Turn-off energy	E_{off}		-	0.84	-	mJ
Total switching energy	E_{ts}		-	1.25	-	mJ

Diode Characteristic, at $T_{vj} = 175^{\circ}\text{C}$

Diode reverse recovery time	t_{rr}	$T_{vj} = 175^{\circ}\text{C}$, $V_R = 400\text{V}$, $I_F = 15.0\text{A}$, $di_F/dt = 1300\text{A}/\mu\text{s}$	-	190	-	ns
Diode reverse recovery charge	Q_{rr}		-	1.70	-	μC
Diode peak reverse recovery current	I_{rrm}		-	27.0	-	A
Diode peak rate of fall of reverse recovery current during t_b	di_{rr}/dt		-	-280	-	$\text{A}/\mu\text{s}$

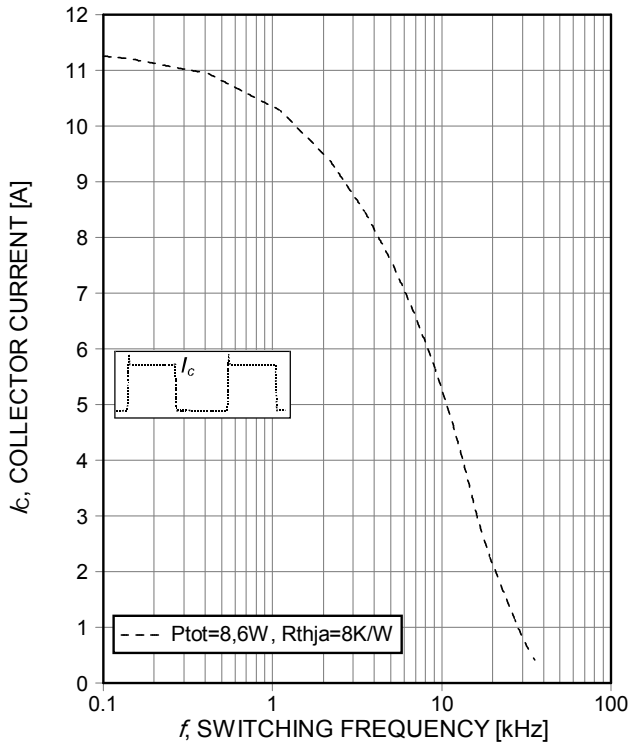

Figure 1. Collector current as a function of switching frequency
 ($T_{vj} \leq 175^\circ\text{C}$, $T_a = 55^\circ\text{C}$, $D = 0.5$, $V_{CE} = 400\text{V}$, $V_{GE} = 15/0\text{V}$, $r_G = 15\Omega$, PCB mounting with thermal vias and heatsink, see Appnote: www.infineon.com/igbt)

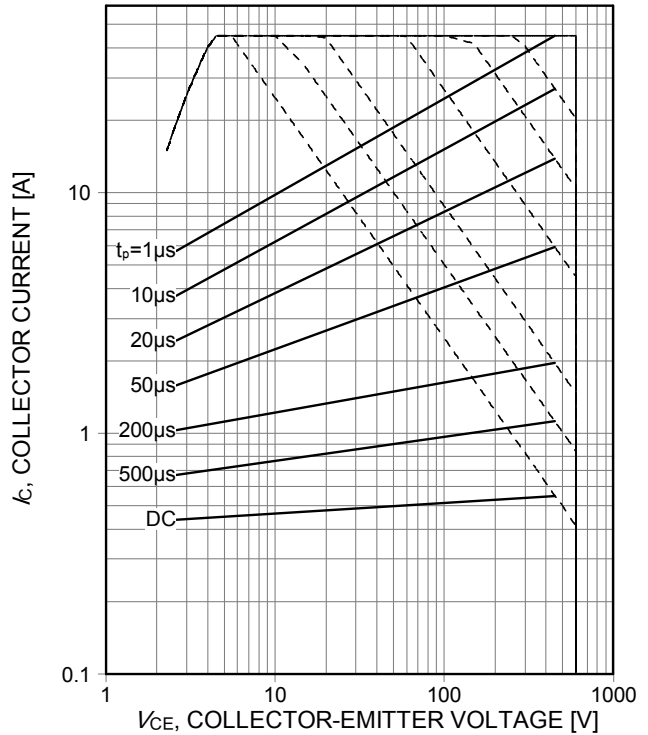

Figure 2. Forward bias safe operating area
 ($D = 0$, $T_C = 25^\circ\text{C}$, $T_{vj} \leq 175^\circ\text{C}$; $V_{GE} = 15\text{V}$)

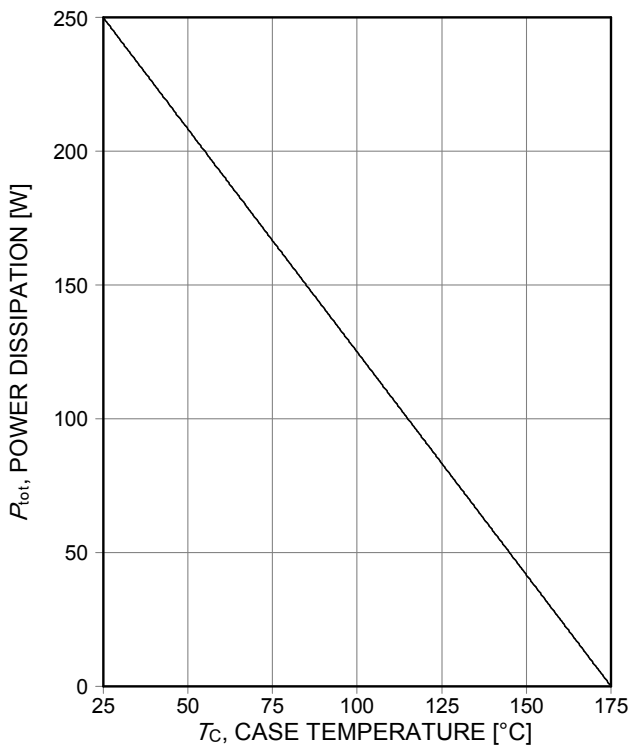

Figure 3. Power dissipation as a function of case temperature
 ($T_{vj} \leq 175^\circ\text{C}$)

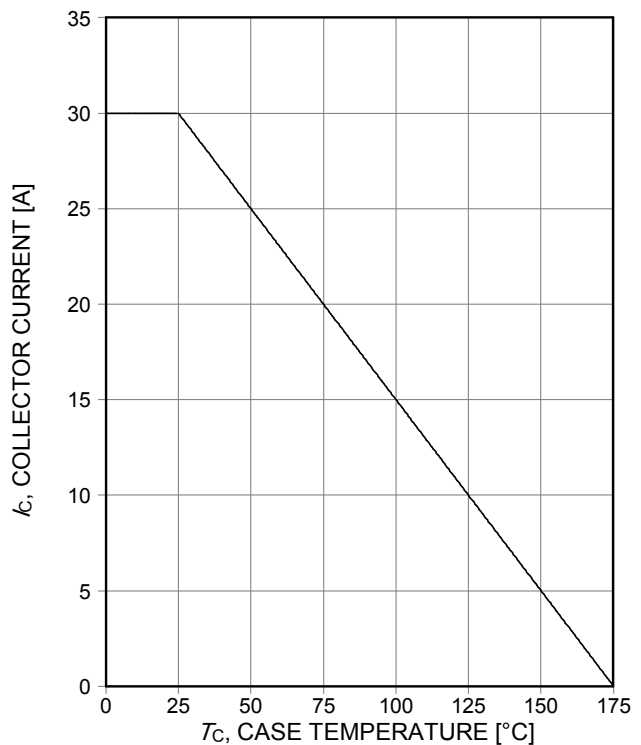

Figure 4. Collector current as a function of case temperature
 ($V_{GE} \geq 15\text{V}$, $T_{vj} \leq 175^\circ\text{C}$)

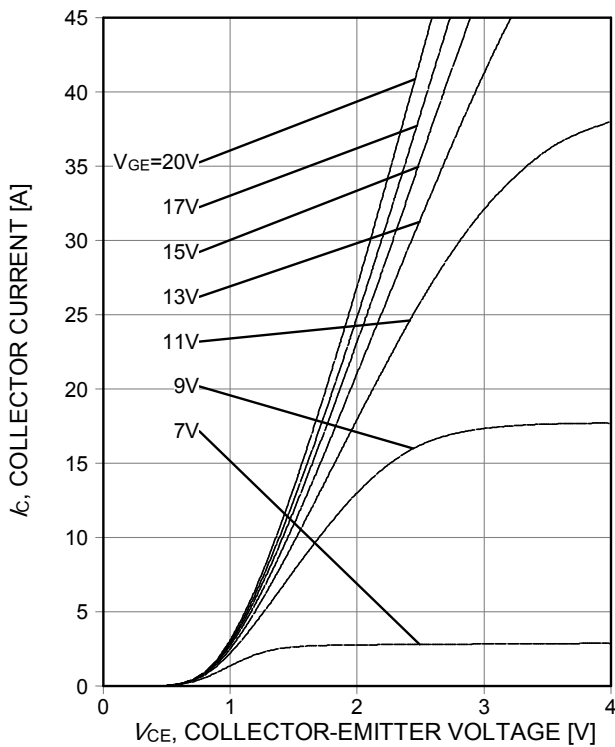

Figure 5. Typical output characteristic
($T_{vj}=25^{\circ}\text{C}$)

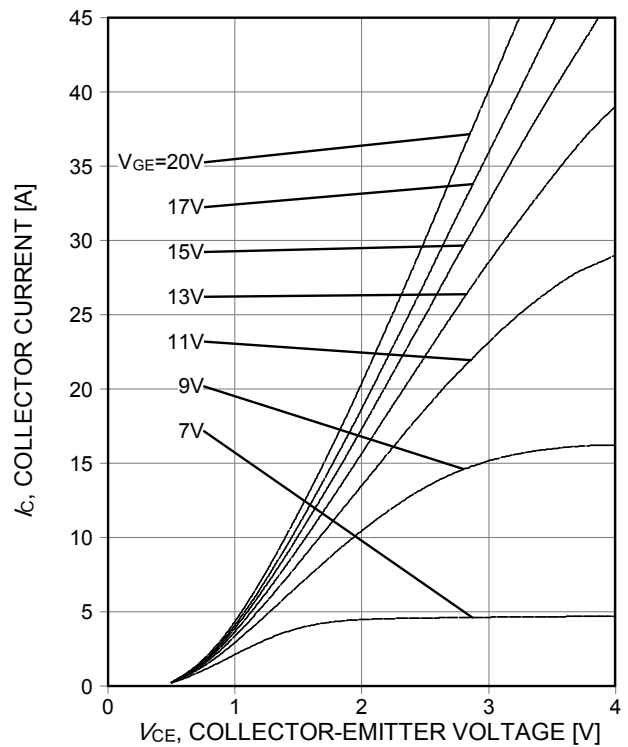

Figure 6. Typical output characteristic
($T_{vj}=175^{\circ}\text{C}$)

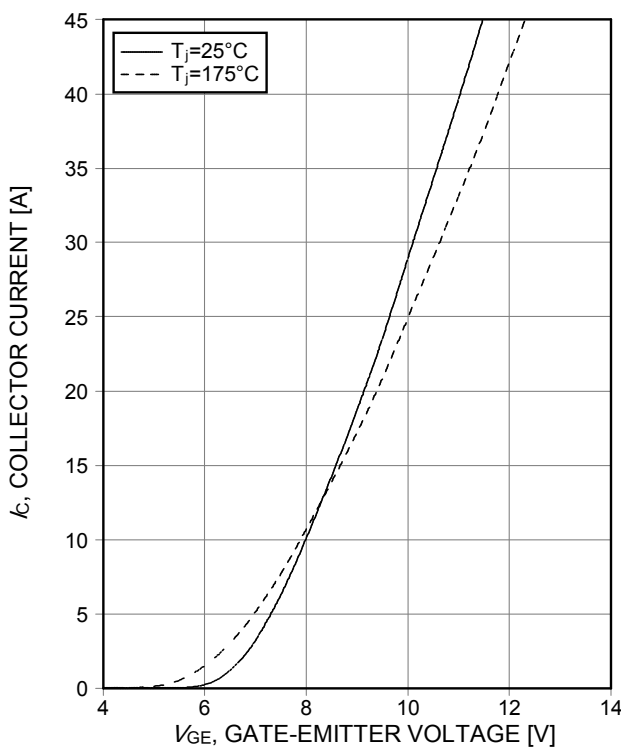

Figure 7. Typical transfer characteristic
($V_{ce}=10\text{V}$)

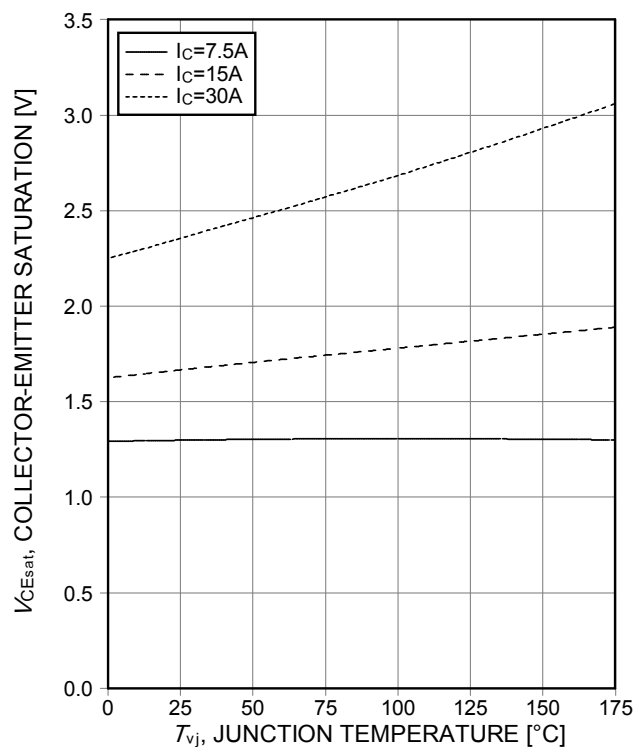

Figure 8. Typical collector-emitter saturation voltage as a function of junction temperature
($V_{ge}=15\text{V}$)

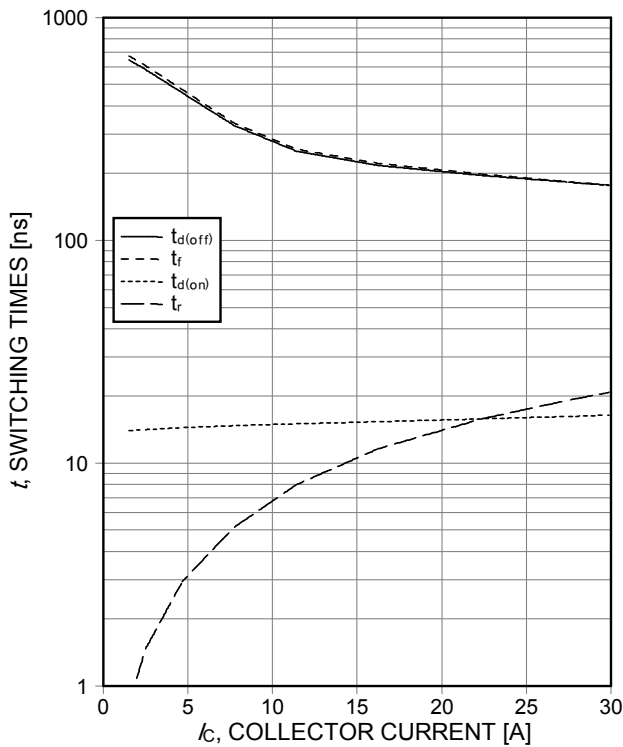

Figure 9. Typical switching times as a function of collector current
(inductive load, $T_{vj}=175^{\circ}\text{C}$, $V_{CE}=400\text{V}$, $V_{GE}=15/0\text{V}$, $r_G=15\Omega$, Dynamic test circuit in Figure E)

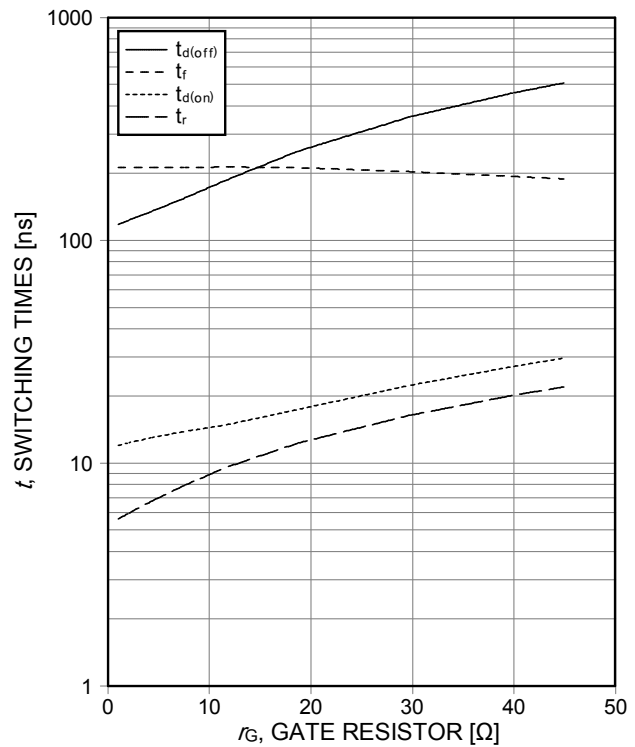

Figure 10. Typical switching times as a function of gate resistor
(inductive load, $T_{vj}=175^{\circ}\text{C}$, $V_{CE}=400\text{V}$, $V_{GE}=15/0\text{V}$, $I_C=15\text{A}$, Dynamic test circuit in Figure E)

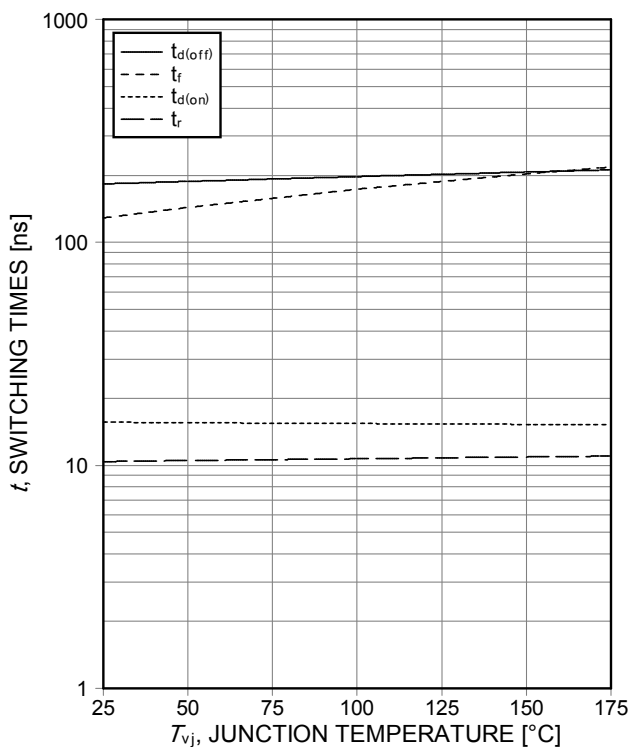

Figure 11. Typical switching times as a function of junction temperature
(inductive load, $V_{CE}=400\text{V}$, $V_{GE}=15/0\text{V}$, $I_C=15\text{A}$, $r_G=15\Omega$, Dynamic test circuit in Figure E)

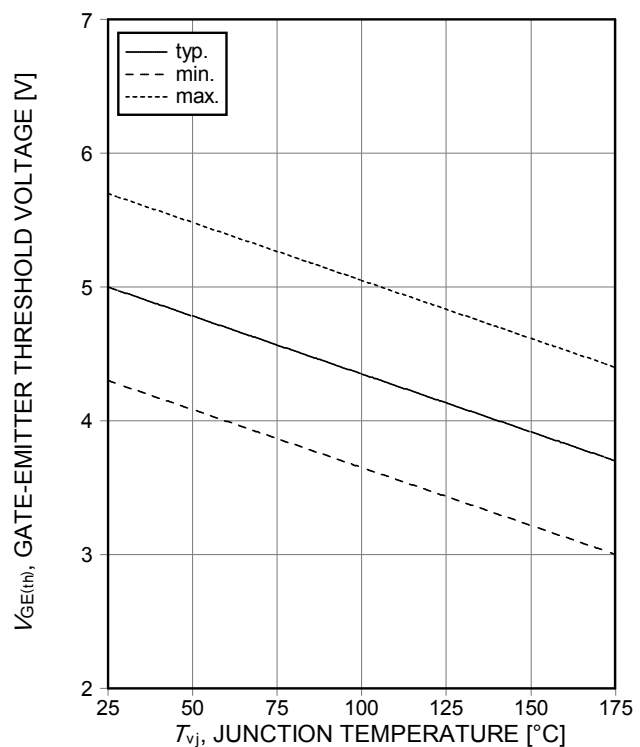

Figure 12. Gate-emitter threshold voltage as a function of junction temperature
($I_C=0.25\text{mA}$)

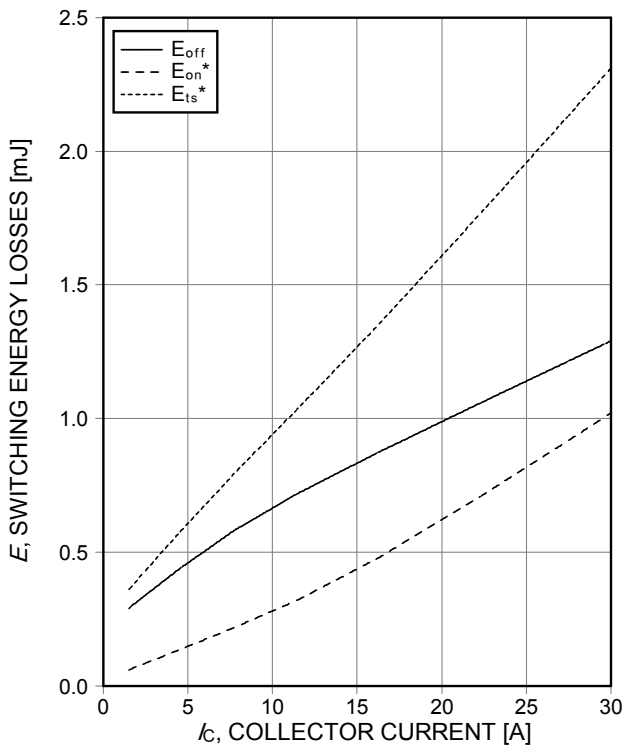

Figure 13. Typical switching energy losses as a function of collector current
 (inductive load, $T_{vj}=175^\circ\text{C}$, $V_{CE}=400\text{V}$, $V_{GE}=15/0\text{V}$, $r_G=15\Omega$, Dynamic test circuit in Figure E)

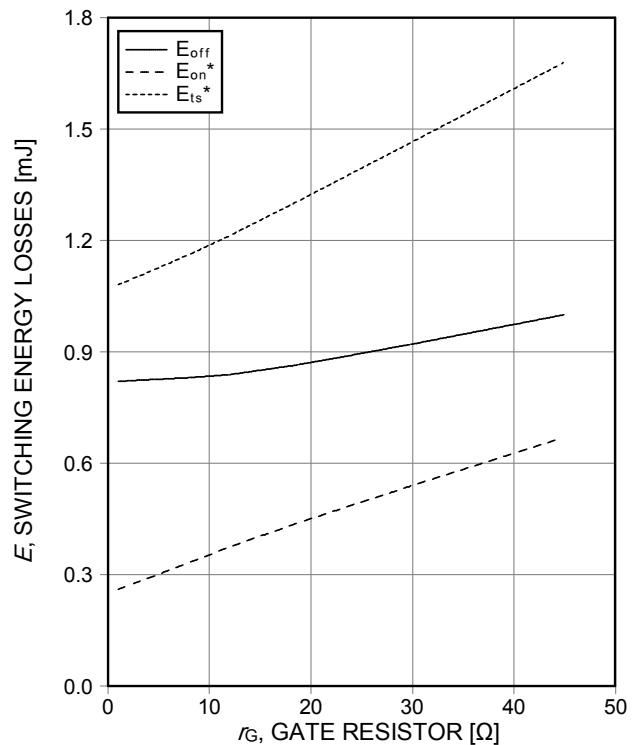

Figure 14. Typical switching energy losses as a function of gate resistor
 (inductive load, $T_{vj}=175^\circ\text{C}$, $V_{CE}=400\text{V}$, $V_{GE}=15/0\text{V}$, $I_C=15\text{A}$, Dynamic test circuit in Figure E)

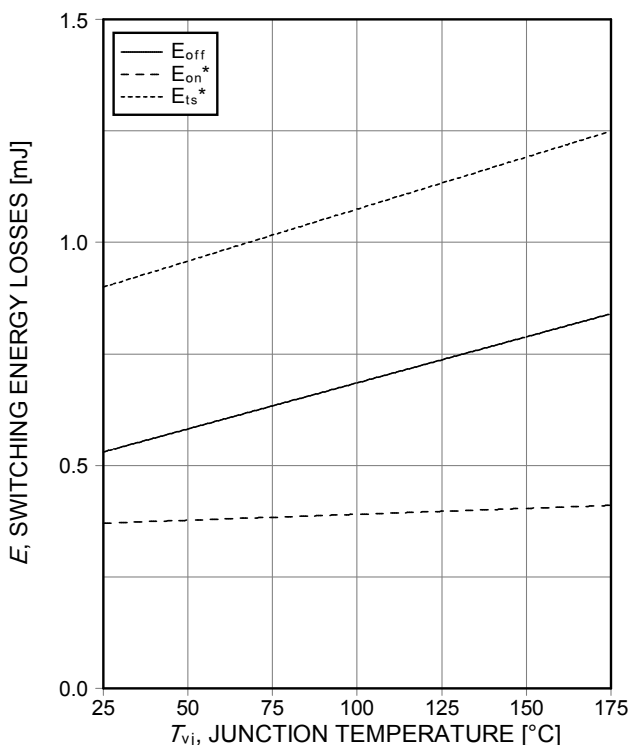

Figure 15. Typical switching energy losses as a function of junction temperature
 (inductive load, $V_{CE}=400\text{V}$, $V_{GE}=15/0\text{V}$, $I_C=15\text{A}$, $r_G=15\Omega$, Dynamic test circuit in Figure E)

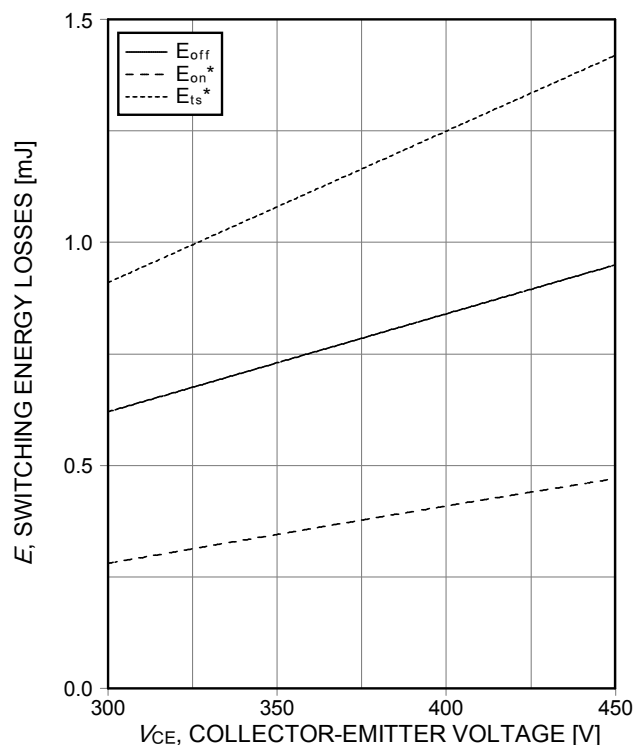

Figure 16. Typical switching energy losses as a function of collector emitter voltage
 (inductive load, $T_{vj}=175^\circ\text{C}$, $V_{GE}=15/0\text{V}$, $I_C=15\text{A}$, $r_G=15\Omega$, Dynamic test circuit in Figure E)

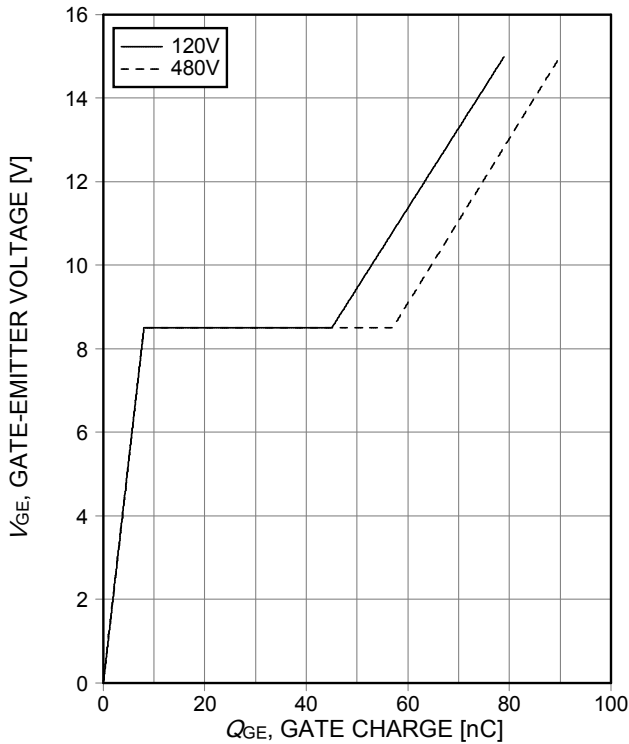

Figure 17. Typical gate charge
($I_C=15A$)

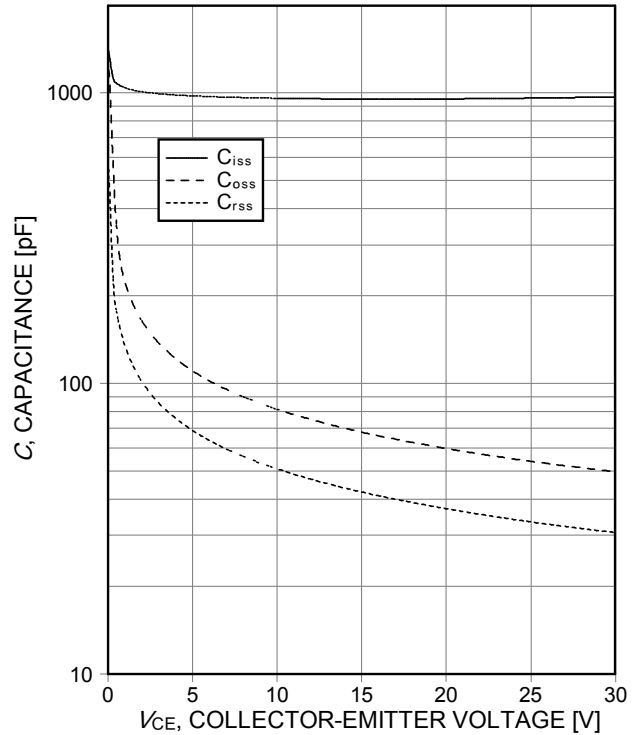

Figure 18. Typical capacitance as a function of collector-emitter voltage
($V_{GE}=0V$, $f=1MHz$)

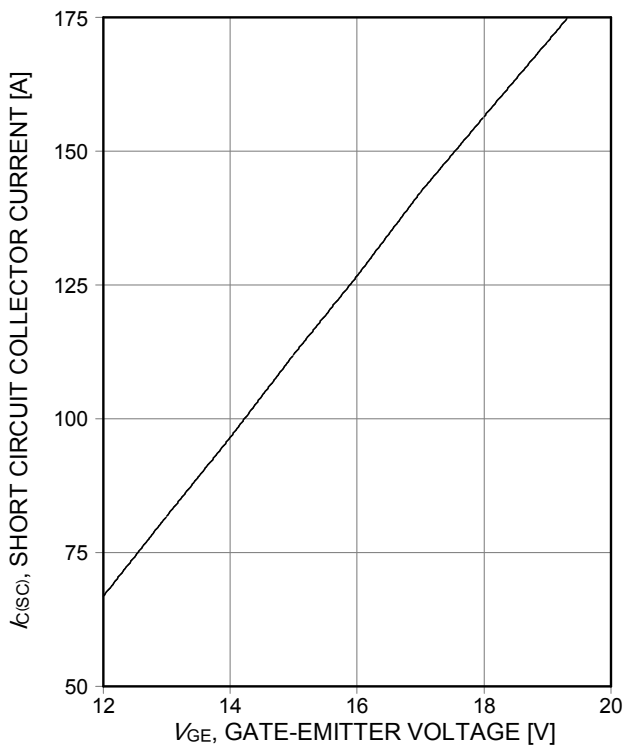

Figure 19. Typical short circuit collector current as a function of gate-emitter voltage
($V_{CE} \leq 400V$, start at $T_{vj}=25^\circ C$)

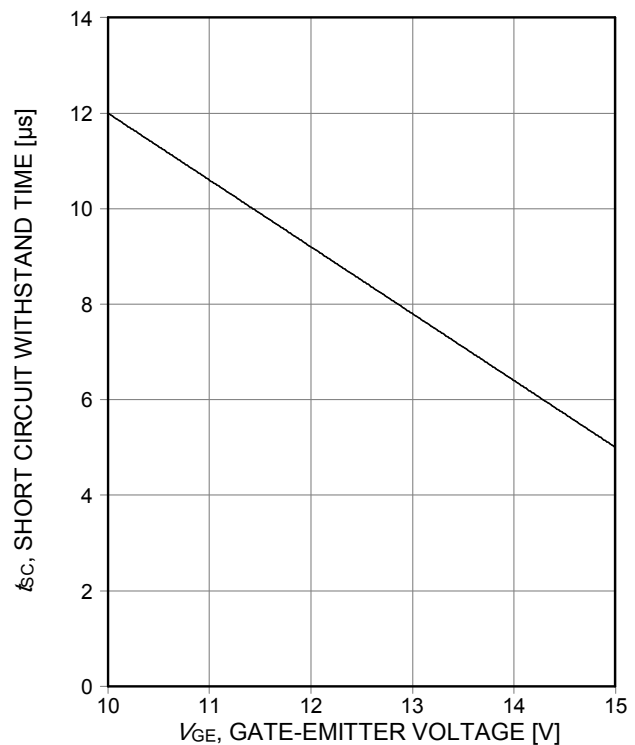

Figure 20. Short circuit withstand time as a function of gate-emitter voltage
($V_{CE} \leq 400V$, start at $T_{vj} \leq 150^\circ C$)

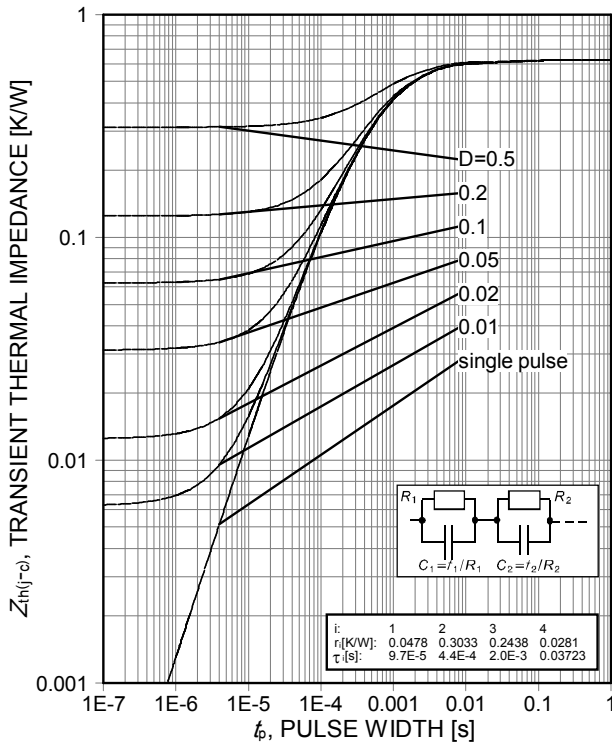

Figure 21. IGBT transient thermal impedance as a function of pulse width ¹⁾ (see page 4)
($D=t_p/T$)

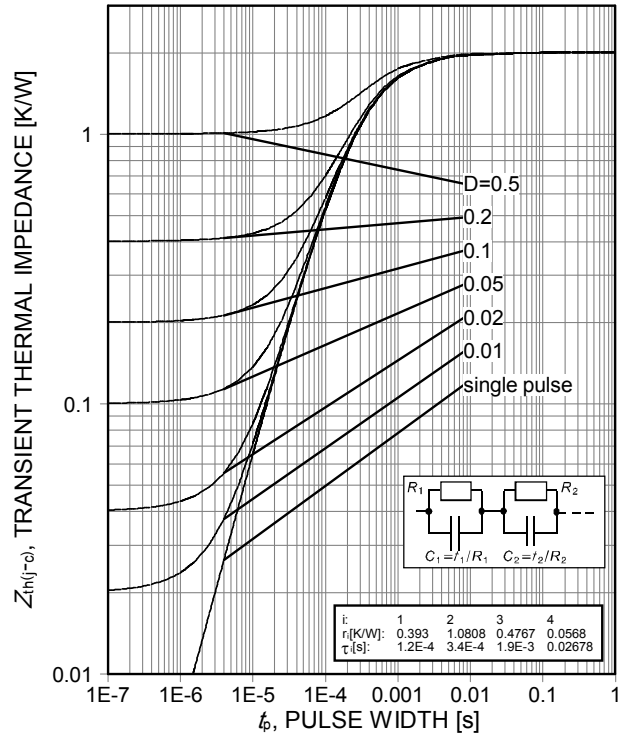

Figure 22. Diode transient thermal impedance as a function of pulse width ²⁾ (see page 4)
($D=t_p/T$)

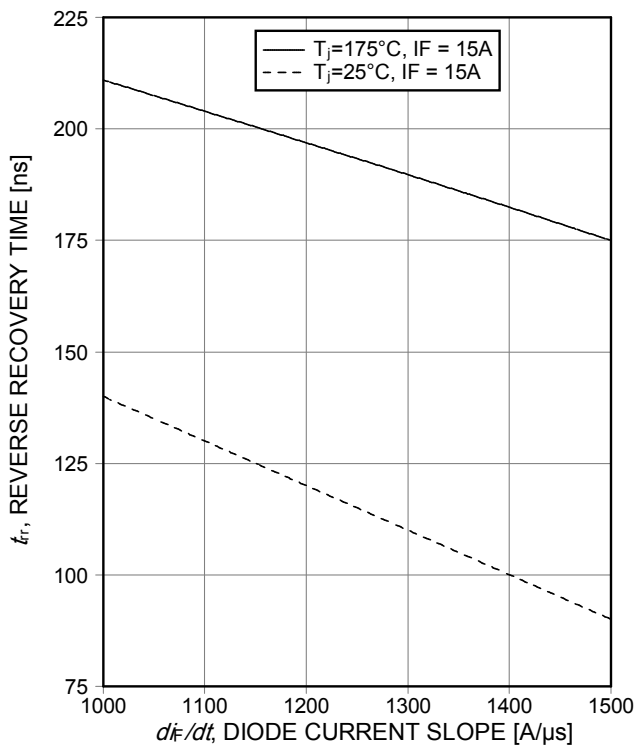

Figure 23. Typical reverse recovery time as a function of diode current slope
($V_R=400V$)

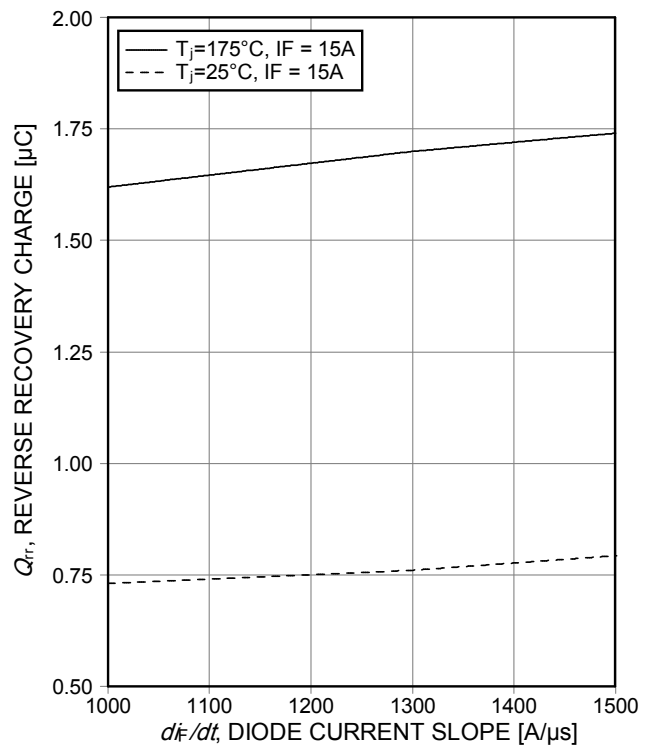

Figure 24. Typical reverse recovery charge as a function of diode current slope
($V_R=400V$)

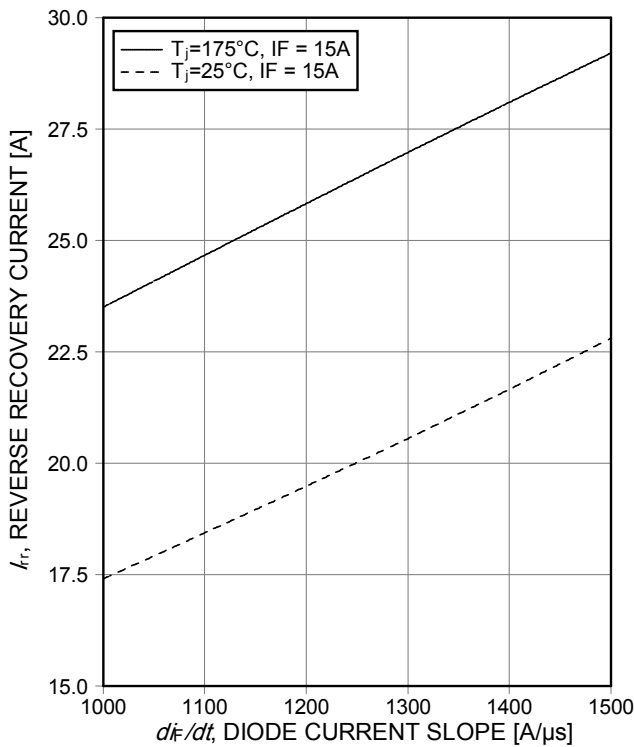

Figure 25. Typical reverse recovery current as a function of diode current slope
($V_R=400V$)

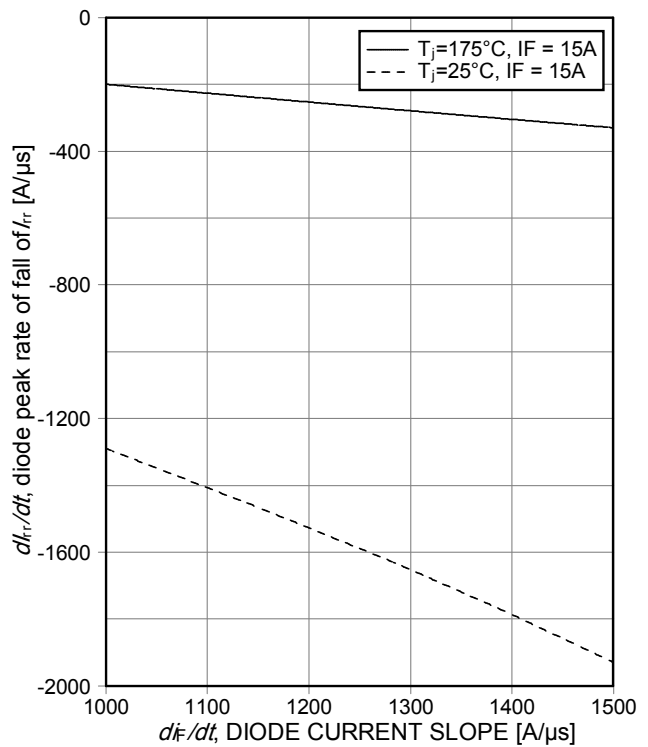

Figure 26. Typical diode peak rate of fall of reverse recovery current as a function of diode current slope
($V_R=400V$)

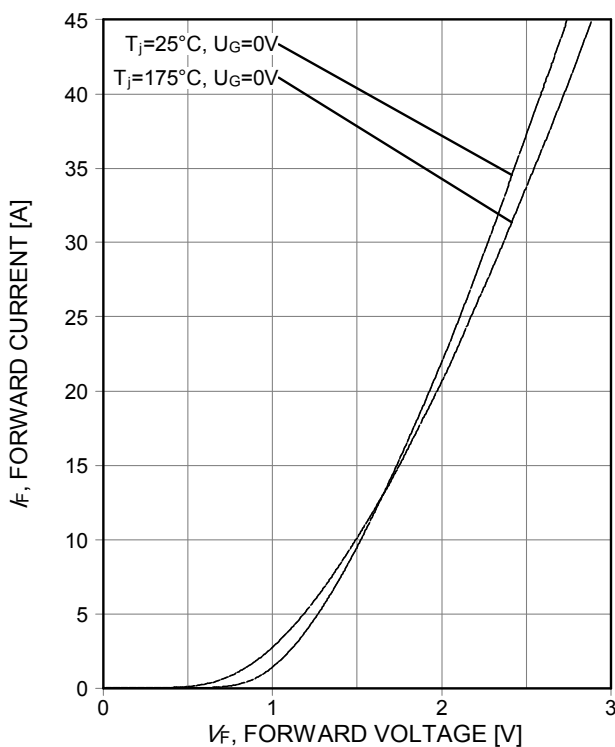

Figure 27. Typical diode forward current as a function of forward voltage

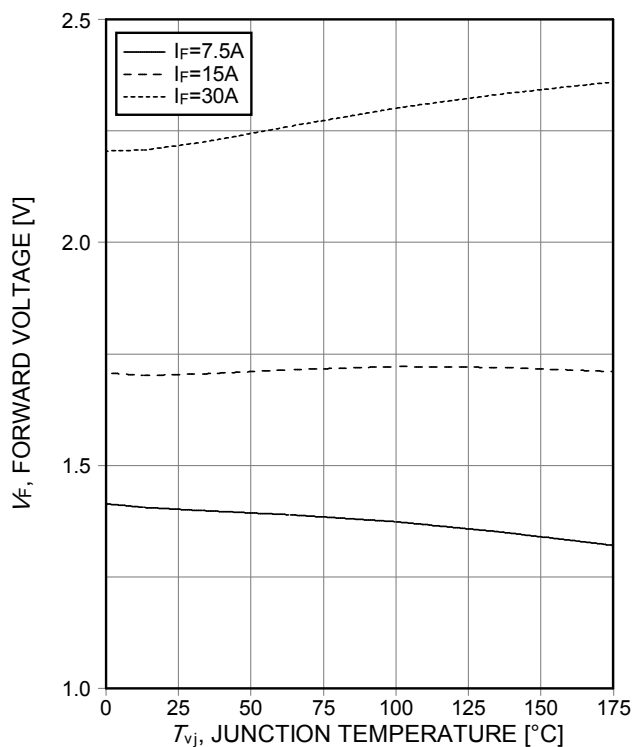
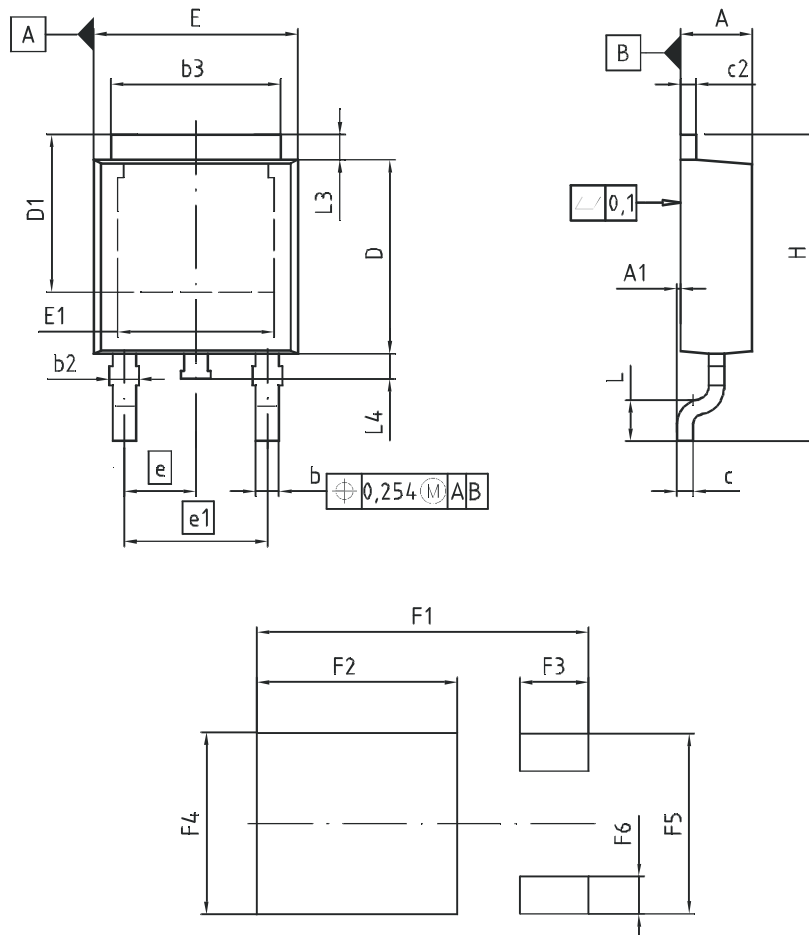

Figure 28. Typical diode forward voltage as a function of junction temperature

PG- TO252-3



DIM	MILLIMETERS		INCHES	
	MIN	MAX	MIN	MAX
A	2.16	2.41	0.085	0.095
A1	0.00	0.15	0.000	0.006
b	0.64	0.89	0.025	0.035
b2	0.65	1.15	0.026	0.045
b3	5.00	5.50	0.197	0.217
c	0.46	0.60	0.018	0.024
c2	0.46	0.98	0.018	0.039
D	5.97	6.22	0.235	0.245
D1	5.02	5.84	0.198	0.230
E	6.40	6.73	0.252	0.265
E1	4.70	5.21	0.185	0.205
e	2.29		0.090	
e1	4.57		0.180	
N	3		3	
H	9.40	10.48	0.370	0.413
L	1.18	1.70	0.046	0.067
L3	0.90	1.25	0.035	0.049
L4	0.51	1.00	0.020	0.039
F1	10.50	10.70	0.413	0.421
F2	6.30	6.50	0.248	0.256
F3	2.10	2.30	0.083	0.091
F4	5.70	5.90	0.224	0.232
F5	5.66	5.86	0.223	0.231
F6	1.10	1.30	0.043	0.051

DOCUMENT NO.
Z8B00003328

SCALE 0 2.0 4mm

EUROPEAN PROJECTION

ISSUE DATE
19-10-2007

REVISION
03

PG-TO251-3

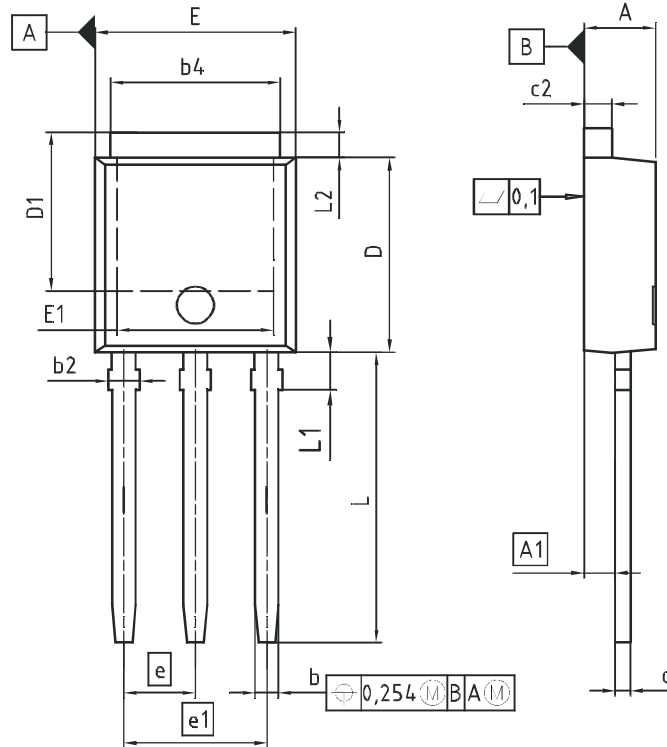

DIM	MILLIMETERS		INCHES	
	MIN	MAX	MIN	MAX
A	2.16	2.41	0.085	0.095
A1	0.90	1.14	0.035	0.045
b	0.64	0.89	0.025	0.035
b2	0.65	1.15	0.026	0.045
b4	4.95	5.50	0.195	0.217
c	0.46	0.60	0.018	0.024
c2	0.46	0.89	0.018	0.035
D	5.97	6.22	0.235	0.245
D1	5.04	5.77	0.198	0.227
E	6.35	6.73	0.250	0.265
E1	4.70	5.21	0.185	0.205
e	2.29		0.090	
e1	4.57		0.180	
N	3		3	
L	8.89	9.65	0.350	0.380
L1	1.90	2.29	0.075	0.090
L2	0.89	1.37	0.035	0.054

DOCUMENT NO.
Z8B00003330

SCALE

EUROPEAN PROJECTION

ISSUE DATE
19-03-2008

REVISION
03

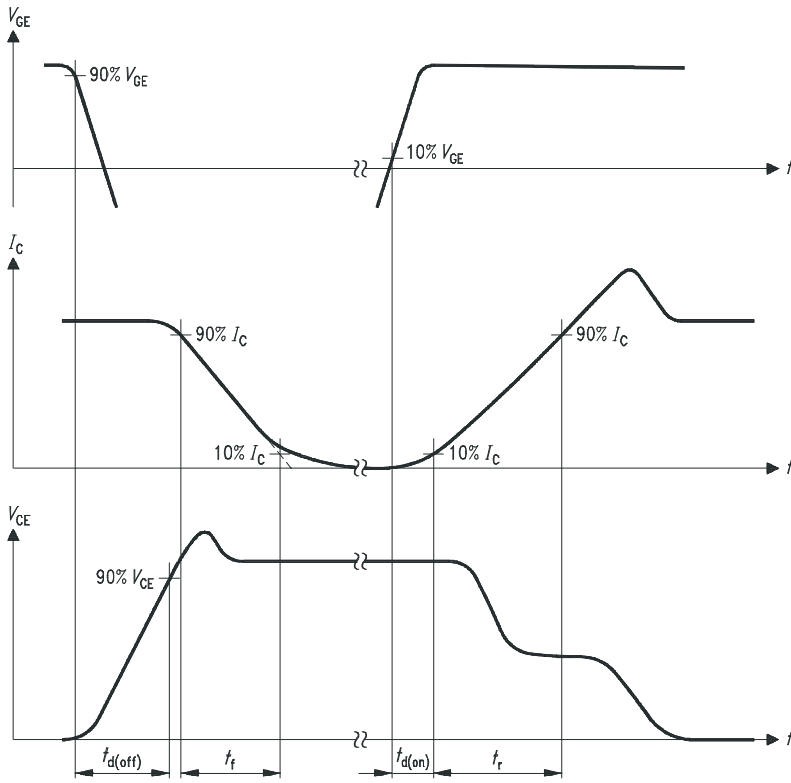

Figure A. Definition of switching times

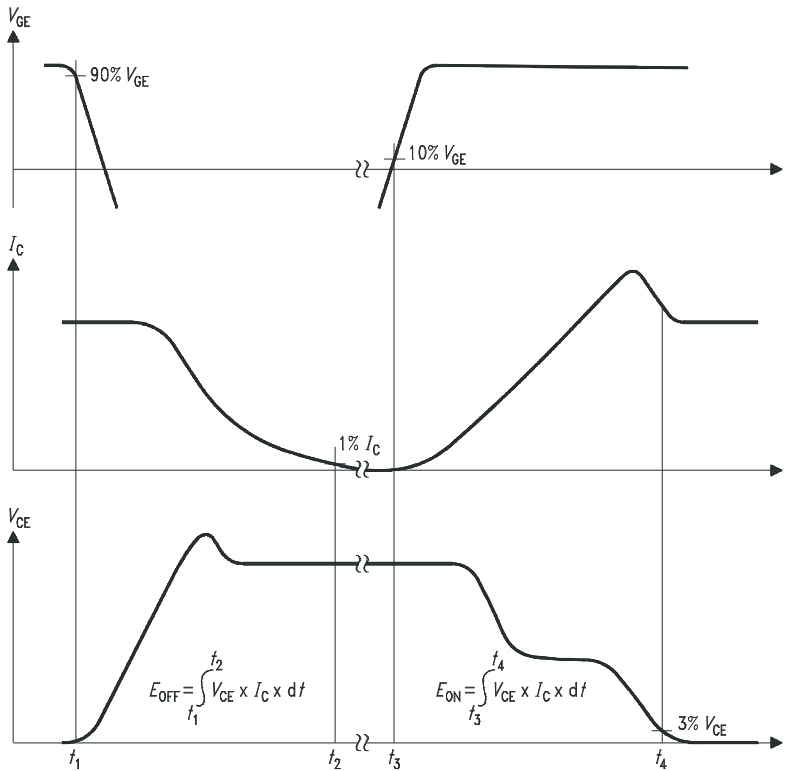

Figure B. Definition of switching losses

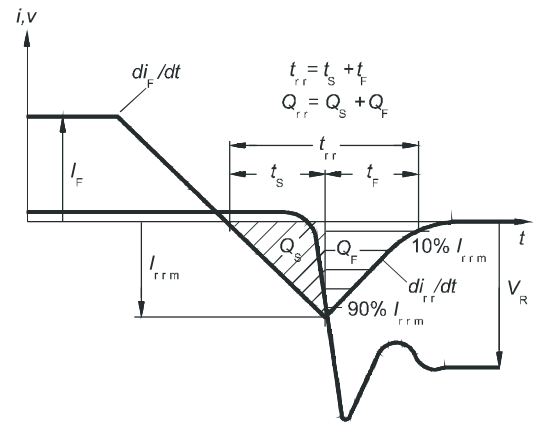

Figure C. Definition of diodes switching characteristics

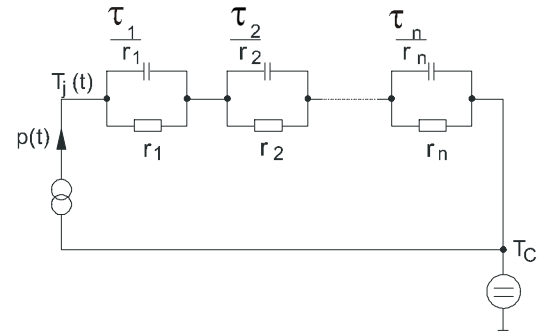

Figure D. Thermal equivalent circuit

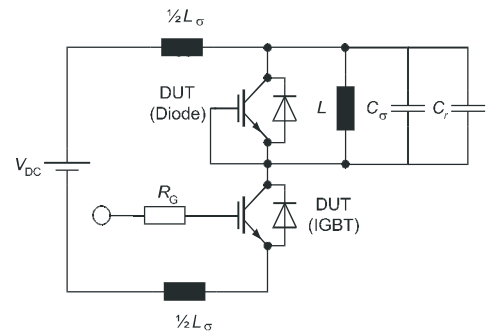

Figure E. Dynamic test circuit
 Parasitic inductance L_{σ} ,
 Parasitic capacitor C_{σ} ,
 Relief capacitor C_r
 (only for ZVT switching)



Revision History

IKD15N60R, IKU15N60R

Revision: 2011-01-17, Rev. 2.1

Previous Revision

Revision	Date	Subjects (major changes since last revision)
0.1	2010-02-01	-
2.1	-	Release of final datasheet

We Listen to Your Comments

Any information within this document that you feel is wrong, unclear or missing at all ?

Your feedback will help us to continuously improve the quality of this document.

Please send your proposal (including a reference to this document) to: erratum@infineon.com

Published by

Infineon Technologies AG

81726 Munich, Germany

81726 München, Germany

© 2010 Infineon Technologies AG

All Rights Reserved.

Legal Disclaimer

The information given in this document shall in no event be regarded as a guarantee of conditions or characteristics. With respect to any examples or hints given herein, any typical values stated herein and/or any information regarding the application of the device, Infineon Technologies hereby disclaims any and all warranties and liabilities of any kind, including without limitation, warranties of non-infringement of intellectual property rights of any third party.

Information

For further information on technology, delivery terms and conditions and prices, please contact the nearest Infineon Technologies Office (www.infineon.com).

Warnings

Due to technical requirements, components may contain dangerous substances. For information on the types in question, please contact the nearest Infineon Technologies Office. Infineon Technologies components may be used in life-support devices or systems only with the express written approval of Infineon Technologies, if a failure of such components can reasonably be expected to cause the failure of that life-support device or system or to affect the safety or effectiveness of that device or system. Life support devices or systems are intended to be implanted in the human body or to support and/or maintain and sustain and/or protect human life. If they fail, it is reasonable to assume that the health of the user or other persons may be endangered.