

# TPS61372 16-V, 3.8-A Synchronous Boost With Load Disconnect

## 1 Features

- Input voltage range: 2.5 V to 5.5 V
- Output voltage range: up to 16 V
- On-resistance:
  - Low-side FET - 33 mΩ
  - High-side FET - 104 mΩ
- Switch peak current limit: 3.8 A
- Quiescent current from  $V_{IN}$ : 74  $\mu$ A
- Quiescent current from  $V_{OUT}$ : 10  $\mu$ A
- Shutdown current from  $V_{IN}$ : 1  $\mu$ A
- Switching frequency: 1.5 MHz
- Soft-start time: 0.9 ms
- Hiccup output short protection
- Auto PFM and forced PWM selectable
- Load disconnect during shutdown
- External loop compensation
- Output overvoltage protection
- 1.57-mm  $\times$  1.52-mm  $\times$  0.5 mm 16-pin WCSPs
- Create a custom design using the TPS61372 with [WEBENCH® Power Designer](#)

## 2 Applications

- RF PA driver
- [NAND flash](#)
- [Backup power](#)
- [Motor driver](#)
- [Optical sensor driver](#)

## 3 Description

The TPS61372 is a full-integrated synchronous boost converter with the load disconnect built-in. The device supports output voltage up to 16 V with a 3.8-A current limit. The input voltage ranges from 2.5-V to 5.5-V supporting applications powered by a single-cell Lithium-ion battery or 5-V bus.

The TPS61372 uses the peak current mode with the adaptive off-time control topology. The device works in PWM operation of 1.5 MHz at moderate-to-heavy loads. At the light load conditions, the device can be configured in either auto PFM or forced PWM operation by the MODE pin connection. Auto PFM mode has the benefit of high efficiency at light load while forced PWM operation keeps the switching frequency constant across the whole load range. The TPS61372 has a soft start to minimize the inrush current during start-up. The TPS61372 features of the load disconnect during shut down and provides a output short protection of hiccup mode. In addition, the device implements output overvoltage and thermal shutdown protection. The TPS61372 delivers a compact solution size with a 16-pin WCSP 1.57-mm  $\times$  1.52-mm package of 0.5-mm height.

### Device Information

PART NUMBER	PACKAGE <sup>(1)</sup>	BODY SIZE (NOM)
TPS61372	DSBGA (16)	1.57 mm $\times$ 1.52 mm

(1) For all available packages, see the orderable addendum at the end of the data sheet.

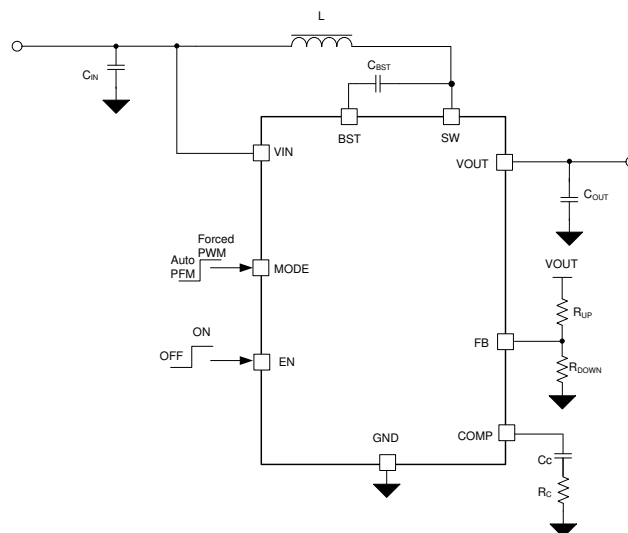

**Typical Application Circuit**



## Table of Contents

<b>1 Features</b> .....	<b>1</b>	<b>8 Application and Implementation</b> .....	<b>12</b>
<b>2 Applications</b> .....	<b>1</b>	8.1 Application Information.....	12
<b>3 Description</b> .....	<b>1</b>	8.2 Typical Application.....	12
<b>4 Revision History</b> .....	<b>2</b>	<b>9 Power Supply Recommendations</b> .....	<b>22</b>
<b>5 Pin Configuration and Functions</b> .....	<b>3</b>	<b>10 Layout</b> .....	<b>23</b>
<b>6 Specifications</b> .....	<b>4</b>	10.1 Layout Guidelines.....	23
6.1 Absolute Maximum Ratings.....	4	10.2 Layout Example.....	23
6.2 ESD Ratings.....	4	<b>11 Device and Documentation Support</b> .....	<b>25</b>
6.3 Recommended Operating Conditions.....	4	11.1 Device Support.....	25
6.4 Thermal Information.....	5	11.2 Receiving Notification of Documentation Updates..	25
6.5 Electrical Characteristics.....	5	11.3 Support Resources.....	25
6.6 Typical Characteristics.....	7	11.4 Trademarks.....	25
<b>7 Detailed Description</b> .....	<b>9</b>	11.5 Electrostatic Discharge Caution.....	25
7.1 Overview.....	9	11.6 Glossary.....	25
7.2 Functional Block Diagram.....	9	<b>12 Mechanical, Packaging, and Orderable Information</b> .....	<b>26</b>
7.3 Feature Description.....	10		
7.4 Device Functional Modes.....	11		

## 4 Revision History

NOTE: Page numbers for previous revisions may differ from page numbers in the current version.

<b>Changes from Revision A (October 2018) to Revision B (January 2021)</b>	<b>Page</b>
• Updated the numbering format for tables, figures and cross-references throughout the document. ....	1
• Changed 2 to S in <a href="#">Equation 11</a> .....	17
• Updated <a href="#">Section 8.2.2.7</a> .....	19

---

<b>Changes from Revision * (June 2018) to Revision A (October 2018)</b>	<b>Page</b>
• First release of production-data data sheet .....	1

## 5 Pin Configuration and Functions

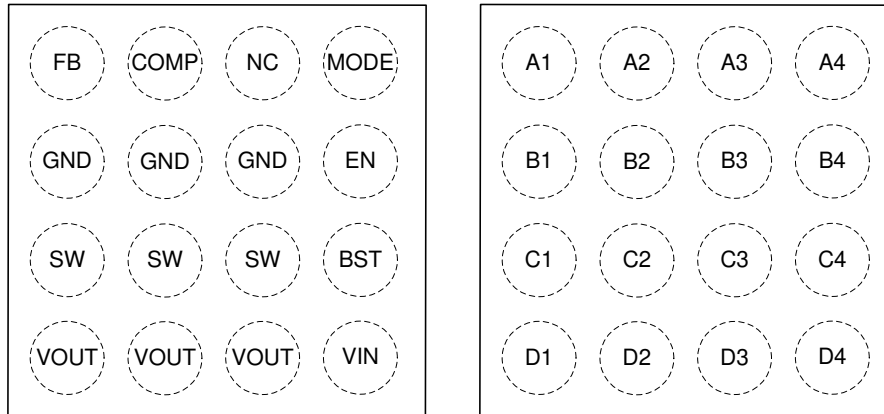

**Figure 5-1. YKB Package 16-Pin DSBGA (Top View)**

**Table 5-1. Pin Functions**

PIN		I/O	DESCRIPTION
NUMBER	NAME		
A1	FB	I	Output voltage feedback. A resistor divider connecting to this pin sets the output voltage.
A2	COMP	O	Output of the internal error amplifier. The loop compensation network must be connected between this pin and GND.
A3	NC	I	No connection. Tie directly to VIN pin. Do not connect with GND or leave it floating.
A4	MODE	I	Operation mode selection pin. MODE = low, the device works in auto PFM mode with good light load efficiency. MODE = high, the device is in forced PWM mode and keeps the switching frequency constant across the whole load range.
B1, B2, B3	GND	-	Ground
B4	EN	I	Enable logic input. Logic high level enables the device. Logic low level disables the device and turns it into shutdown mode.
C1, C2, C3	SW	PWR	The switching node pin of the converter. It is connected to the drain of the internal low-side FET and the source of the internal high-side FET.
C4	BST	O	Power supply for the high-side FET gate driver. A capacitor must be connected between this pin and the SW pin.
D1, D2, D3	VOUT	PWR	Boost converter output
D4	VIN	I	IC power supply input

## 6 Specifications

### 6.1 Absolute Maximum Ratings

over operating free-air temperature range (unless otherwise noted)<sup>(1)</sup>

		MIN	MAX	UNIT
Voltage range at terminals <sup>(2)</sup>	BST	-0.3	SW+6	V
Voltage range at terminals <sup>(2)</sup>	SW, VOUT	-0.3	19	V
Voltage range at terminals <sup>(2)</sup>	VIN, EN, COMP, FB, MODE, NC	-0.3	6	V
Operating junction temperature, T <sub>J</sub>		-40	150	°C
Storage temperature, T <sub>stg</sub>		-65	150	°C

- (1) Stresses beyond those listed under *Absolute Maximum Ratings* may cause permanent damage to the device. These are stress ratings only, which do not imply functional operation of the device at these or any other conditions beyond those indicated under *Recommended Operating Conditions*. Exposure to absolute-maximum-rated conditions for extended periods may affect device reliability.
- (2) All voltage values are with respect to network ground terminal.

### 6.2 ESD Ratings

		VALUE	UNIT
V <sub>(ESD)</sub> <sup>(1)</sup>	Electrostatic discharge	Human-body model (HBM), per ANSI/ESDA/JEDEC JS-001 <sup>(2)</sup>	±1500
		Charged-device model (CDM), per JEDEC specification JESD22-C101 <sup>(3)</sup>	±500

- (1) Electrostatic discharge (ESD) to measure device sensitivity and immunity to damage caused by assembly line electrostatic discharges in to the device.
- (2) Level listed above is the passing level per ANSI, ESDA, and JEDEC JS-001. JEDEC document JEP155 states that 500-V HBM allows safe manufacturing with a standard ESD control process. Manufacturing with less than 500-V HBM is possible with the necessary precautions.
- (3) Level listed above is the passing level per EIA-JEDEC JESD22-C101. JEDEC document JEP157 states that 250-V CDM allows safe manufacturing with a standard ESD control process. Manufacturing with less than 250-V CDM is possible with the necessary precautions.

### 6.3 Recommended Operating Conditions

Over operating free-air temperature range unless otherwise noted.

		MIN	NOM	MAX	UNIT
V <sub>IN</sub>	Input voltage	2.5		5.5	V
V <sub>OUT</sub>	Output voltage	5		16	V
T <sub>J</sub>	Operating junction temperature	-40		125	°C

## 6.4 Thermal Information

THERMAL METRIC <sup>(1)</sup>		TPS61372	UNIT
		YKB	
		16 PINS	
R <sub>θJA</sub>	Junction-to-ambient thermal resistance	87.1	°C/W
R <sub>θJC(top)</sub>	Junction-to-case (top) thermal resistance	0.7	°C/W
R <sub>θJB</sub>	Junction-to-board thermal resistance	24.1	°C/W
ψ <sub>JT</sub>	Junction-to-top characterization parameter	0.4	°C/W
ψ <sub>JB</sub>	Junction-to-board characterization parameter	24.3	°C/W

(1) For more information about traditional and new thermal metrics, see the *Semiconductor and IC Package Thermal Metrics* application report, SPRA953.

## 6.5 Electrical Characteristics

V<sub>IN</sub> = 2.5 V to 5.5 V and V<sub>OUT</sub> = 5 V to 16 V, T<sub>J</sub> = -40°C to 125°C, Typical values are at T<sub>J</sub> = 25°C, unless otherwise noted.

PARAMETER		TEST CONDITION	MIN	TYP	MAX	UNIT
<b>POWER SUPPLY</b>						
V <sub>IN_UVLO</sub>	Input voltage under voltage lockout (UVLO) threshold, rising	V <sub>OUT</sub> = 12 V, T <sub>J</sub> = -40°C to 125°C			2.32	V
	Input voltage under voltage lockout (UVLO) threshold, falling				2.1	V
I <sub>Q</sub>	Quiescent current into VIN pin	IC enabled, no switching T <sub>J</sub> = -40°C to 85°C		74	110	μA
I <sub>Q</sub>	Quiescent current into VOUT pin	IC enabled, no switching, V <sub>IN</sub> = 2.5 V, V <sub>OUT</sub> = 5 V to 16 V, T <sub>J</sub> = -40°C to 85°C		10	26	μA
I <sub>SD</sub>	Shutdown current from VIN to GND	V <sub>IN</sub> = 2.5 V to 5.5 V, V <sub>OUT</sub> = SW = 0 V, EN = 0, T <sub>J</sub> = -40°C to 85°C		0.03	1	μA
<b>OUTPUT VOLTAGE</b>						
V <sub>REF</sub>	Reference voltage on FB pin		0.585	0.594	0.603	V
	AUTO PFM mode	V <sub>IN</sub> = 4 V, V <sub>OUT</sub> = 12 V, T <sub>J</sub> = 25°C		1.016		V <sub>REF</sub>
I <sub>FB_LKG</sub>	Leakage current into FB pin				30	nA
<b>POWER SWITCHES</b>						
R <sub>DS(on)</sub>	Low-side FET on resistance	V <sub>IN</sub> = 4 V, V <sub>OUT</sub> = 12 V, T <sub>J</sub> = 25°C		33		mΩ
	High-side + Dis connect FET on resistance	V <sub>IN</sub> = 4 V, V <sub>OUT</sub> = 12 V, T <sub>J</sub> = 25°C		104		mΩ
<b>CURRENT LIMIT</b>						
I <sub>LIM</sub>	Current Limit (Auto PFM)	V <sub>IN</sub> = 3 V to 4.5 V, V <sub>OUT</sub> = 5 V to 16 V, T <sub>J</sub> = -40°C to 125°C	3.4	3.8	4.3	A
	Current Limit (Forced PWM)	V <sub>IN</sub> = 3 V to 4.5 V, V <sub>OUT</sub> = 5 V to 16 V, T <sub>J</sub> = -40°C to 125°C	3.28	3.6	4.0	A
<b>EN, MODE LOGICS</b>						
V <sub>IH</sub>	EN, MODE pin high level input voltage				1.2	V
V <sub>IL</sub>	EN, MODE pin low level input voltage		0.4			V
V <sub>HYS</sub>	EN, MODE pin Hysteresis			100		mV
T <sub>DEGLITCH</sub>	EN, MODE deglitch time rising / falling	V <sub>IN</sub> = 4 V, V <sub>OUT</sub> = 12 V, T <sub>J</sub> = 25°C		13		μS
R <sub>PD</sub>	EN, MODE pull down resistor	V <sub>IN</sub> = 4 V, V <sub>OUT</sub> = 12 V, T <sub>J</sub> = 25°C		800		kΩ
<b>SWITCHING CHARACTER</b>						

$V_{IN} = 2.5\text{ V to }5.5\text{ V}$  and  $V_{OUT} = 5\text{ V to }16\text{ V}$ ,  $T_J = -40^\circ\text{C to }125^\circ\text{C}$ , Typical values are at  $T_J = 25^\circ\text{C}$ , unless otherwise noted.

PARAMETER		TEST CONDITION	MIN	TYP	MAX	UNIT
$f_{SW}$	Switch frequency	$V_{IN} = 3\text{ V to }4.5\text{ V}$ , $V_{OUT} = 5\text{ V to }12\text{ V}$ , $T_J = -40^\circ\text{C to }125^\circ\text{C}$	1.2		1.7	MHz
$f_{SW\_FOLD}$	Switch frequency foldback	$V_{IN} = 4\text{ V}$ , $T_J = -40^\circ\text{C to }125^\circ\text{C}$	470	535	600	kHz
$V_{FSW\_LOW}$	Threshold for fsw foldback (1.5 MHz normal)	$V_{IN} = 4\text{ V}$ , $T_J = -40^\circ\text{C to }125^\circ\text{C}$	15%	20%	25%	$V_{IN}$
$V_{FSW\_LOW\_HSY}$	Hysteresis for fsw foldback	$V_{IN} = 4\text{ V}$ , $T_J = 25^\circ\text{C}$		150		mV

**TIMING**

$t_{ON\_MIN}$	Minimum on time	$V_{IN} = 4\text{ V}$ , $T_J = -40^\circ\text{C to }125^\circ\text{C}$		75	95	ns
$t_{SS}$	Soft-start time	$V_{IN} = 4\text{ V}$ , $V_{OUT} = 12\text{ V}$ , $T_J = 25^\circ\text{C}$		0.9		ms
$t_{HIC\_ON}$	Off time of hiccup cycle	$V_{IN} = 4\text{ V}$ , $V_{OUT} = 12\text{ V}$ , $T_J = 25^\circ\text{C}$		74		ms
$t_{HIC\_OFF}$	On time of hiccup cycle	$V_{IN} = 4\text{ V}$ , $V_{OUT} = 12\text{ V}$ , $T_J = 25^\circ\text{C}$		1.9		ms

**ERROR AMPLIFIER**

$V_{COMP}$	COMP output high voltage Auto PFM	$V_{IN} = 4\text{ V}$ , $V_{OUT} = 12\text{ V}$ , $T_J = 25^\circ\text{C}$ , $V_{FB} = V_{REF} - 200\text{mV}$		1.4		V
	COMP output high voltage Forced PWM	$V_{IN} = 4\text{ V}$ , $V_{OUT} = 12\text{ V}$ , $T_J = 25^\circ\text{C}$ , $V_{FB} = V_{REF} - 200\text{mV}$		1.5		V
$V_{COMPL}$	COMP output low voltage Auto PFM	$V_{IN} = 4\text{ V}$ , $V_{OUT} = 12\text{ V}$ , $T_J = 25^\circ\text{C}$ , $V_{FB} = V_{REF} + 200\text{mV}$		0.8		V
	COMP output low voltage Forced PWM	$V_{IN} = 4\text{ V}$ , $V_{OUT} = 12\text{ V}$ , $T_J = 25^\circ\text{C}$ , $V_{FB} = V_{REF} + 200\text{mV}$		0.6		V
Gm	Error amplifier trans conductance	$V_{IN} = 4\text{ V}$ , $V_{OUT} = 12\text{ V}$ , $T_J = 25^\circ\text{C}$		175		$\mu\text{S}$
$I_{SINK\_EA}$	Sink current of COMP	$V_{IN} = 4\text{ V}$ , $T_J = 25^\circ\text{C}$ , $V_{FB} = V_{REF} + 200\text{mV}$		20		$\mu\text{A}$
$I_{SOURCE\_EA}$	Source current of COMP	$V_{IN} = 4\text{ V}$ , $T_J = 25^\circ\text{C}$ , $V_{FB} = V_{REF} - 200\text{mV}$		20		$\mu\text{A}$

**PROTECTION**

$V_{OVP}$	Output over-voltage protection threshold	$V_{IN} = 2.5\text{ V to }5.5\text{ V}$ , $T_J = -40^\circ\text{C to }125^\circ\text{C}$	16.5	17.3	18	V
$V_{OVP\_HYS}$	Output over-voltage protection hysteresis	$V_{IN} = 4\text{ V}$ , $V_{OUT} = 12\text{ V}$ , $T_J = 25^\circ\text{C}$		500		mV

**THERMAL**

$T_{SD}$	Thermal shutdown threshold	$V_{IN} = 4\text{ V}$ , $V_{OUT} = 12\text{ V}$		140		$^\circ\text{C}$
$T_{SD\_HYS}$	Thermal shutdown hysteresis	$V_{IN} = 4\text{ V}$ , $V_{OUT} = 12\text{ V}$		20		$^\circ\text{C}$

## 6.6 Typical Characteristics

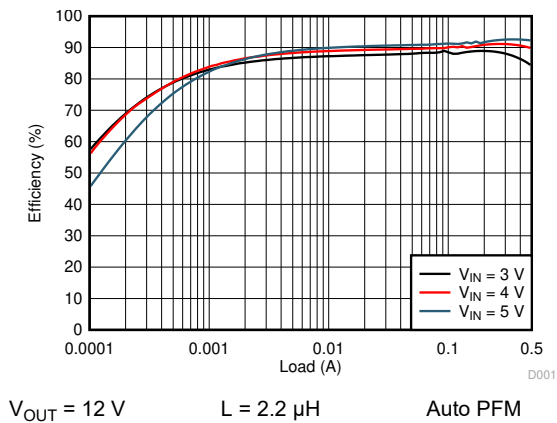

**Figure 6-1. Efficiency vs Load**

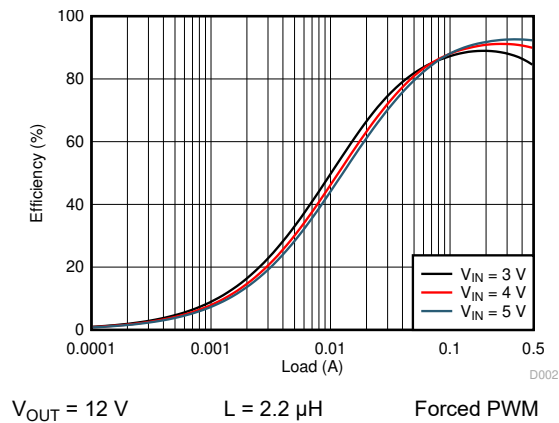

**Figure 6-2. Efficiency vs Load**

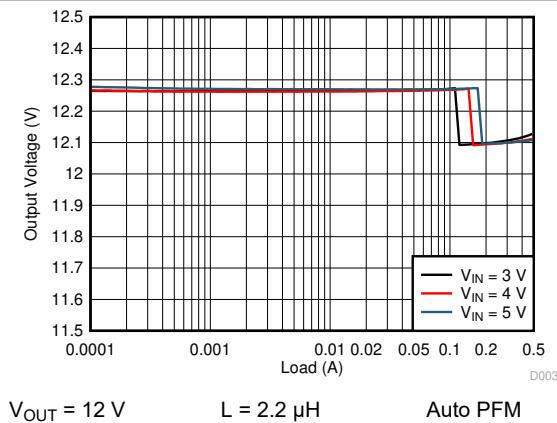

**Figure 6-3. Load Regulation**

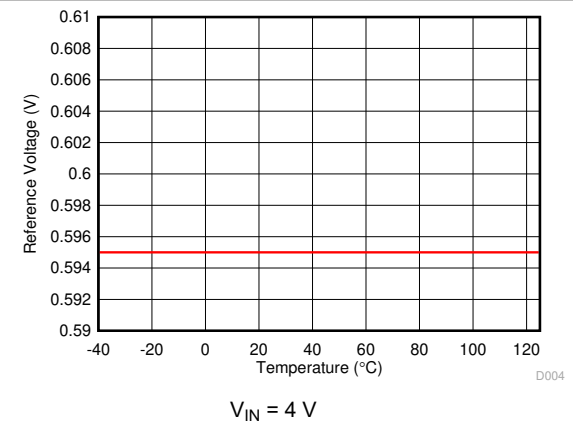

**Figure 6-4. Reference Voltage vs Temperature**

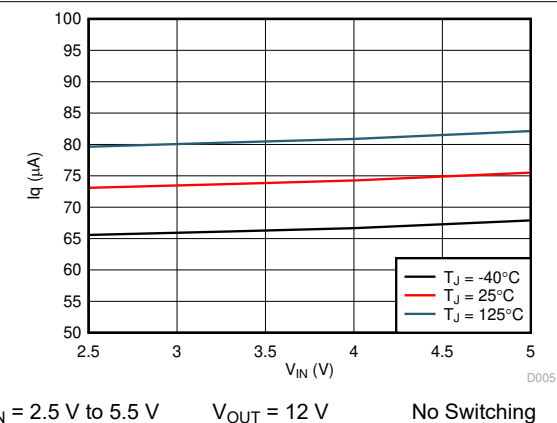

**Figure 6-5.  $I_q$  vs  $V_{IN}$**

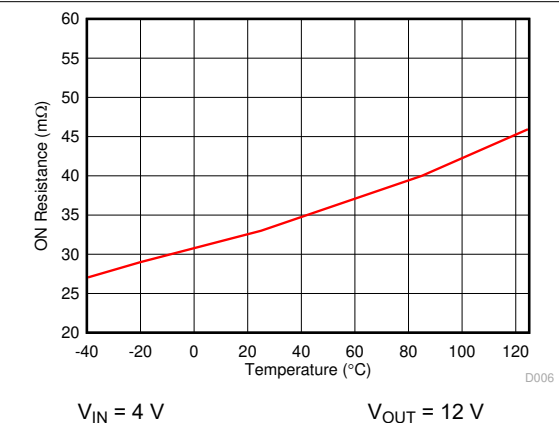

**Figure 6-6. Low-Side  $R_{DS(ON)}$  vs Temperature**

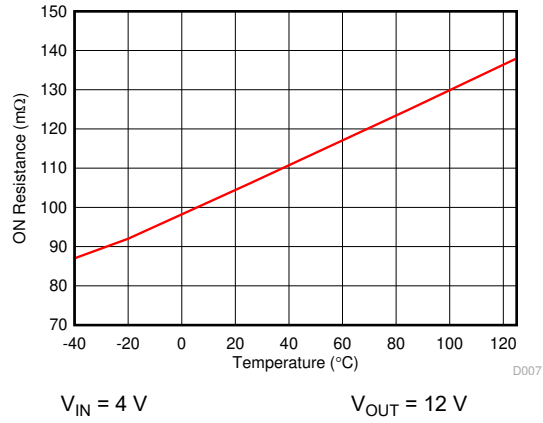

**Figure 6-7. High-side RDS<sub>ON</sub> vs Temperature**

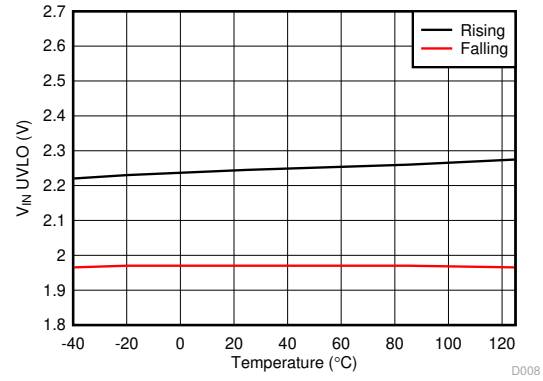

**Figure 6-8. UVLO Threshold vs Temperature**



## 7 Detailed Description

### 7.1 Overview

The TPS61372 is a highly-integrated synchronous boost converter to support 16-V output with load disconnect and short protection built-in. The TPS61372 supports input voltage ranging from 2.5 V to 5.5 V. The TPS61372 uses the peak current mode with adaptive off-time control topology to regulate the output voltage. The TPS61372 operates at a quasi-constant frequency pulse-width modulation (PWM) at moderate to heavy load current. At the beginning of each cycle, the low-side FET turns on and the inductor current ramps up to reach a peak current determined by the output of the error amplifier (EA). When the peak current pre-set value determined by the output trips of the EA, the low-side FET turns off. As long as the low-side FET turns off, the high-side FET turns on after a short delay time to avoid the shoot through. The duration of low-side FET off state is determined by the  $V_{IN} / V_{OUT}$  ratio.

High efficiency is achieved at light load as the TPS61372 operates in PFM operation. The device can be also configured at forced PWM mode to keep the frequency constant across the whole load range and to have more immunity against noise sensitive applications.

### 7.2 Functional Block Diagram

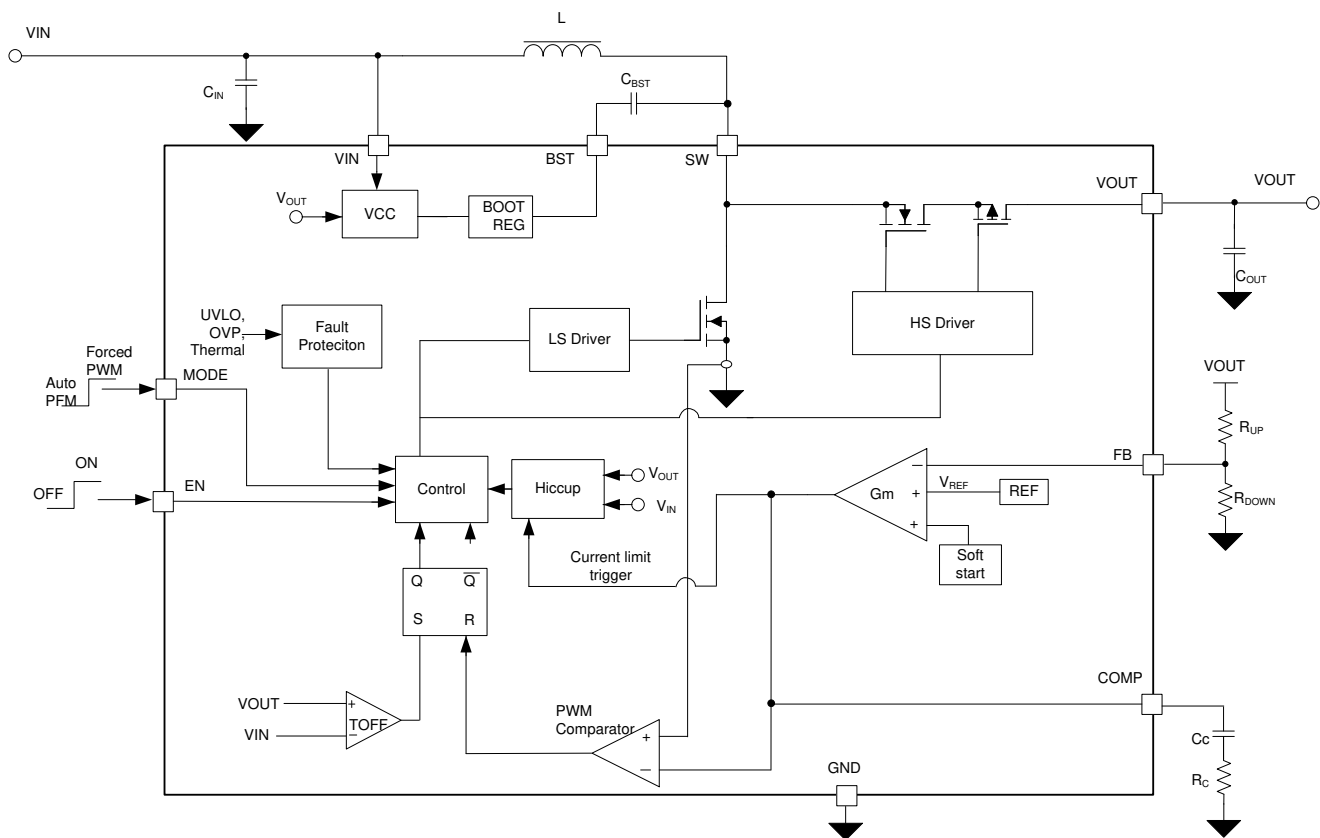

## 7.3 Feature Description

### 7.3.1 Undervoltage Lockout

The undervoltage lockout (UVLO) circuit prevents the device from malfunctioning at the low input voltage of the battery from the excessive discharge. The device starts operation once the rising  $V_{IN}$  trips the UVLO threshold and it disables the output stage of the converter once  $V_{IN}$  is below the UVLO falling threshold.

### 7.3.2 Enable and Disable

When the input voltage is above the UVLO threshold and the EN pin is pulled above the high threshold (1.2 V minimum), the TPS61372 is enabled. When the EN pin is pulled below the low threshold (0.4 V maximum), the TPS61372 goes into shutdown mode.

### 7.3.3 Error Amplifier

The TPS61372 has a transconductance amplifier and compares the feedback voltage with the internal voltage reference (or the internal soft-start voltage during start-up phase). The transconductance of the error amplifier is 175  $\mu\text{A} / \text{V}$  typically. The loop compensation components are placed between the COMP terminal and ground to optimize the loop stability and response speed.

### 7.3.4 Bootstrap Voltage (BST)

The TPS61372 has an integrated bootstrap regulator and requires a small ceramic capacitor between the BST and SW pin to provide the gate drive voltage for the high-side FET. The recommended value for this ceramic capacitor is between 20 nF to 200 nF.

### 7.3.5 Load Disconnect

The TPS61372 device provides a load disconnect function, which completely disconnects the output from the input during shutdown or fault conditions.

### 7.3.6 Overvoltage Protection

If the output voltage is detected above the overvoltage protection threshold (typically 17.3 V), the TPS61372 stops switching immediately until the voltage at the  $V_{OUT}$  pin drops below the output overvoltage protection recovery threshold (with 500-mV hysteresis). This function prevents the devices against the overvoltage and secures the circuits connected with the output of excessive overvoltage.

### 7.3.7 Thermal Shutdown

A thermal shutdown is implemented to prevent the damage due to the excessive heat and power dissipation. Typically, the thermal shutdown occurs at the junction temperature exceeding 140°C (typical). When the thermal shutdown is triggered, the device stops switching and recovers when the junction temperature falls below 120°C (typical).

### 7.3.8 Start-Up

The TPS61372 implements the soft start function to reduce the inrush current during start-up. The TPS61372 begins soft start when the EN pin is pulled high. There are two phases for the start-up procedure:

- When  $V_{OUT}$  is below 120%  $V_{IN}$ , the output voltage ramps up with the switching frequency of 535 kHz (typical).
- When  $V_{OUT}$  exceeds 120%  $V_{IN}$ , the switching frequency changes to 1.5 MHz typically and ramps up the output voltage to the setpoint.

### 7.3.9 Short Protection

The TPS61372 provides a hiccup protection mode when output short protection occurs. In hiccup mode, the TPS61372 shuts down after the 1.9-ms duration of current limit is triggered and the  $V_{OUT}$  is pulled below 105%  $V_{IN}$ . In hiccup steady state, the device shuts down itself and restarts after a 74-ms (typical) waiting time, which helps to reduce the overall thermal dissipation at continuous short condition. After the short condition releases, the device can recover automatically and restart the start-up phase.

## 7.4 Device Functional Modes

### 7.4.1 Operation

In light load condition, the TPS61372 can be configured at Auto PFM or Forced PWM. At Auto PFM operation, the switching frequency is lowered at light load and features higher efficiency, while for Forced PWM operation, the frequency keeps constant across the whole load range.

### 7.4.2 Auto PFM Mode

The TPS61372 integrates a power-save mode with pulse frequency modulation (PFM) at light load (set the mode pin low logic or floating). The device skips the switching cycles and regulates the output voltage at a higher threshold (typically  $101.6\% \times V_{OUT\_NORM}$ ). [Figure 7-1](#) shows the working principle of the PFM operation. The auto PFM mode reduces the switching losses and improves efficiency at light load condition by reducing the average switching frequency.

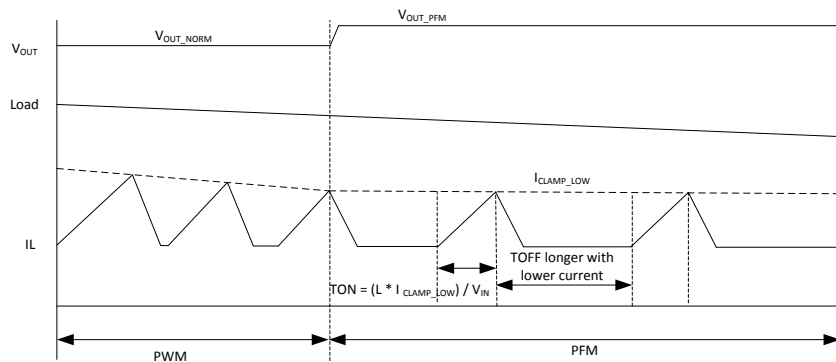

**Figure 7-1. Auto PFM Operation Behavior**

### 7.4.3 Forced PWM Mode

In forced PWM mode, the TPS61372 keeps the switching frequency constant across the whole load range. When the load current decreases, the output of the internal error amplifier decreases as well to lower the inductor peak current and delivers less power. The high-side FET is not turned off even if the current through the FET goes negative to keep the switching frequency be the same as that of the heavy load.

### 7.4.4 Mode Selectable

There is a mode pin to configure the TPS61372 into two different operation modes. The device works in auto PFM mode when pulling the mode pin to low or floating and in forced PWM mode when mode pin is high.

## 8 Application and Implementation

### Note

Information in the following applications sections is not part of the TI component specification, and TI does not warrant its accuracy or completeness. TI's customers are responsible for determining suitability of components for their purposes, as well as validating and testing their design implementation to confirm system functionality.

### 8.1 Application Information

The TPS61372 is a synchronous boost converter. The following design procedure can be used to select component values for the TPS61372. This section presents a simplified discussion of the design process. Alternately, the WEBENCH® software may be used to generate a complete design. The WEBENCH® software uses an interactive design procedure and accesses a comprehensive database of components when generating a design. This section presents a simplified discussion of the design process.

### 8.2 Typical Application

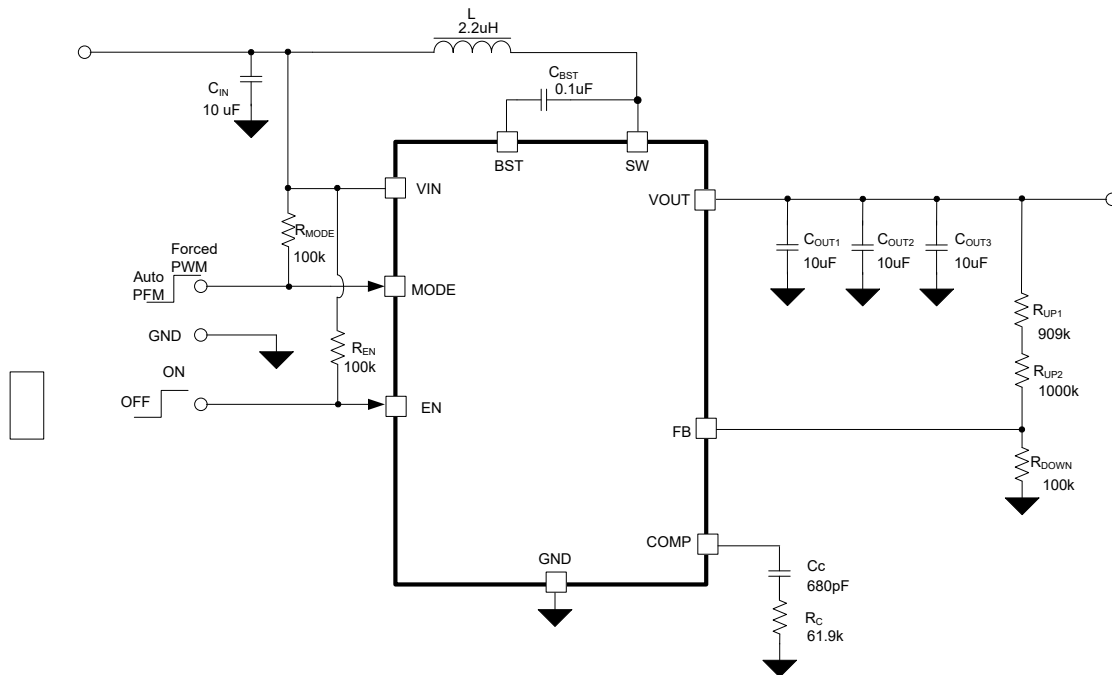

Figure 8-1. TPS61372 12-V Output With Load Disconnect Schematic

## 8.2.1 Design Requirements

For this design example, use [Table 8-1](#) as the design parameters.

**Table 8-1. Design Parameters**

PARAMETER	VALUE
Input voltage range	3 V to 5 V
Output voltage	12 V
Output ripple voltage	± 3%
Output current	0.4 A
Operating frequency	1.5 MHz

## 8.2.2 Detailed Design Procedure

### 8.2.2.1 Custom Design With WEBENCH® Tools

[Click here](#) to create a custom design using the TPS61372 device with the WEBENCH® Power Designer.

1. Start by entering the input voltage ( $V_{IN}$ ), output voltage ( $V_{OUT}$ ), and output current ( $I_{OUT}$ ) requirements.
2. Optimize the design for key parameters such as efficiency, footprint, and cost using the optimizer dial.
3. Compare the generated design with other possible solutions from Texas Instruments.

The WEBENCH Power Designer provides a customized schematic along with a list of materials with real-time pricing and component availability.

In most cases, these actions are available:

- Run electrical simulations to see important waveforms and circuit performance
- Run thermal simulations to understand board thermal performance
- Export customized schematic and layout into popular CAD formats
- Print PDF reports for the design, and share the design with colleagues

Get more information about WEBENCH tools at [www.ti.com/WEBENCH](http://www.ti.com/WEBENCH).

To begin the design process a few parameters must be decided upon. The designer needs to know the following:

- Input voltage range
- Output voltage
- Output ripple voltage
- Output current rating
- Operating frequency

### 8.2.2.2 Setting the Output Voltage

The output voltage of the TPS61372 is externally adjustable using a resistor divider network. The relationship between the output voltage and the resistor divider is given by [Equation 1](#).

$$V_{OUT} = V_{FB} \times \left(1 + \frac{R_{UP}}{R_{DOWN}}\right) \quad (1)$$

where

- $V_{OUT}$  is the output voltage
- $R_{UP}$  is the top divider resistor
- $R_{DOWN}$  is the bottom divider resistor

Choose  $R_{DOWN}$  to be approximately 100 k $\Omega$ . Slightly increasing or decreasing  $R_{DOWN}$  can result in closer output voltage matching when using standard value resistors. In this design,  $R_{DOWN} = 100$  k $\Omega$  and  $R_{UP} = 1.909$  M $\Omega$  (1 M $\Omega$  + 909 k $\Omega$ ), resulting in an output voltage of 12 V.

For the best accuracy, TI recommends  $R_{\text{DOWN}}$  to be around 100 k $\Omega$  to ensure that the current following through  $R_{\text{DOWN}}$  is at least 100 times larger than FB pin leakage current. Changing  $R_{\text{DOWN}}$  towards the lower value increases the robustness against noise injection. Changing  $R_{\text{DOWN}}$  towards the higher values reduces the quiescent current for achieving higher efficiency at the light load currents.

### 8.2.2.3 Selecting the Inductor

A boost converter normally requires two main passive components for storing the energy during power conversion: an inductor and an output capacitor. The inductor affects the steady state efficiency (including the ripple and efficiency) as well as the transient behavior and loop stability, which makes the inductor to be the most critical component in application.

When selecting the inductor, as well as the inductance, the other parameters of importance are:

- The maximum current rating (RMS and peak current should be considered)
- The series resistance
- Operating temperature

Choosing the inductor ripple current with the low ripple percentage of the average inductor current results in a larger inductance value, maximizes the potential output current of the converter, and minimizes EMI. The larger ripple results in a smaller inductance value and a physically smaller inductor, which improves transient response, but results in potentially higher EMI.

The rule of thumb in choosing the inductor is to make sure the inductor ripple current ( $\Delta I_L$ ) is a certain percentage of the average current. The inductance can be calculated by [Equation 2](#), [Equation 3](#), and [Equation 4](#):

$$\Delta I_L = \frac{V_{\text{IN}} \times D}{L \times f_{\text{SW}}} \quad (2)$$

$$\Delta I_{L\_R} = \text{Ripple\%} \times \frac{V_{\text{OUT}} \times I_{\text{OUT}}}{\eta \times V_{\text{IN}}} \quad (3)$$

$$L = \frac{1}{\text{Ripple \%}} \times \frac{\eta \times V_{\text{IN}}}{V_{\text{OUT}} \times I_{\text{OUT}}} \times \frac{V_{\text{IN}} \times D}{f_{\text{SW}}} \quad (4)$$

where

- $\Delta I_L$  is the peak-peak inductor current ripple
- $V_{\text{IN}}$  is the input voltage
- $D$  is the duty cycle
- $L$  is the inductor
- $f_{\text{SW}}$  is the switching frequency
- Ripple% is the ripple ration versus the DC current
- $V_{\text{OUT}}$  is the output voltage
- $I_{\text{OUT}}$  is the output current
- $\eta$  is the efficiency

The current flowing through the inductor is the inductor ripple current plus the average input current. During power up, load faults, or transient load conditions, the inductor current can increase above the peak inductor current calculated.

Inductor values can have  $\pm 20\%$  or even  $\pm 30\%$  tolerance with no current bias. When the inductor current approaches the saturation level, its inductance can decrease 20% to 35% from the value at 0-A bias current depending on how the inductor vendor defines saturation. When selecting an inductor, make sure its rated current, especially the saturation current, is larger than its peak current during the operation.

The inductor peak current varies as a function of the load, the switching frequency, and the input and output voltages and it can be calculated by [Equation 5](#) and [Equation 6](#).

$$I_{PEAK} = I_{IN} + \frac{1}{2} \times \Delta I_L \quad (5)$$

where

- $I_{PEAK}$  is the peak current of the inductor
- $I_{IN}$  is the input average current
- $\Delta I_L$  is the ripple current of the inductor

The input DC current is determined by the output voltage, the output current, and efficiency can be calculated by:

$$I_{IN} = \frac{V_{OUT} \times I_{OUT}}{V_{IN} \times \eta} \quad (6)$$

where

- $I_{IN}$  is the input current of the inductor
- $V_{OUT}$  is the output voltage
- $V_{IN}$  is the input voltage
- $\eta$  is the efficiency

While the inductor ripple current depends on the inductance, the frequency, the input voltage, and duty cycle calculated by [Equation 2](#), replace [Equation 2](#), [Equation 6](#) into [Equation 5](#) to calculate the inductor peak current:

$$I_{PEAK} = \frac{I_{OUT}}{(1-D) \times \eta} + \frac{1}{2} \times \frac{V_{IN} \times D}{L \times f_{SW}} \quad (7)$$

where

- $I_{PEAK}$  is the peak current of the inductor
- $I_{OUT}$  is the output current
- $D$  is the duty cycle
- $\eta$  is the efficiency
- $V_{IN}$  is the input voltage
- $L$  is the inductor
- $f_{SW}$  is the switching frequency

The heat rating current (RMS) is calculated by [Equation 8](#):

$$I_{L\_RMS} = \sqrt{I_{IN}^2 + \frac{1}{12} (\Delta I_L)^2} \quad (8)$$

where

- $I_{L\_RMS}$  is the RMS current of the inductor
- $I_{IN}$  is the input current of the inductor
- $\Delta I_L$  is the ripple current of the inductor

It is important that the peak current does not exceed the inductor saturation current and the RMS current is not over the temperature related rating current of the inductors.

For a given physical inductor size, increasing inductance usually results in an inductor with lower saturation current. The total losses of the coil consists of the DC resistance ( DCR ) loss and the following frequency dependent loss:

- The losses in the core material (magnetic hysteresis loss, especially at high switching frequencies)
- Additional losses in the conductor from the skin effect (current displacement at high frequencies)
- Magnetic field losses of the neighboring windings (proximity effect)

For a certain inductor, the larger current ripple (smaller inductor) generates the higher DC and frequency-dependent loss. An inductor with lower DCR is basically recommended for higher efficiency. However, it is usually a tradeoff between the loss and footprint.

The following inductor series in [Table 8-2](#) from the different suppliers are recommended.

**Table 8-2. Recommended Inductors for TPS61372**

PART NUMBER	L (μH)	DCR Typ (mΩ) TYP.	SATURATION CURRENT / TYP.	SIZE (L × W × H mm)	VENDOR <sup>(1)</sup>
XAL4020-222ME	2.2	35	5.6	4 × 4 × 2	Coilcraft
DFE322512F-2R2M=P2	2.2	66	2.6	3.2 × 2.5 × 1.2	Murata
DFE322520FD-4R7M#	4.7	98	3.4	3.2 × 2.5 × 2.0	Murata

(1) See the [Third-party Products Disclaimer](#).

### 8.2.2.4 Selecting the Output Capacitors

The output capacitor is mainly selected to meet the requirements at load transient or steady state. Then the loop is compensated for the output capacitor selected. The output ripple voltage is related to the equivalent series resistance (ESR) of the capacitor and its capacitance. Assuming a capacitor with zero ESR, the minimum capacitance needed for a given ripple can be calculated by [Equation 9](#):

$$C_{OUT} = \frac{I_{OUT} \times (V_{OUT} - V_{IN})}{f_{SW} \times \Delta V \times V_{OUT}} \quad (9)$$

where

- $C_{OUT}$  is the output capacitor
- $I_{OUT}$  is the output current
- $V_{OUT}$  is the output voltage
- $V_{IN}$  is the input voltage
- $\Delta V$  is the output voltage ripple required
- $f_{SW}$  is the switching frequency

The additional output ripple component caused by ESR is calculated by [Equation 10](#):

$$\Delta V_{ESR} = I_{OUT} \times R_{ESR} \quad (10)$$

where

- $\Delta V_{ESR}$  is the output voltage ripple caused by ESR
- $R_{ESR}$  is the resistor in series with the output capacitor

For the ceramic capacitor, the ESR ripple can be neglected. However, for the tantalum or electrolytic capacitors, it must be considered if used.

Care must be taken when evaluating the rating of a ceramic capacitor under the DC bias. Ceramic capacitors can derate by as much as 70% of its capacitance at its rated voltage. Therefore, enough margins on the voltage rating should be considered to ensure adequate capacitance at the required output voltage.

**Table 8-3. Recommended Output Capacitor for TPS61372**

PART NUMBER	C (μF)	PIECES	DESCRIPTION	SIZE	VENDOR <sup>(1)</sup>
GRM188R61E106MA73D	10	3	X5R, 0603, 5 V, ±20% tolerance	0603	Murata



### 8.2.2.5 Selecting the Input Capacitors

Multilayer ceramic capacitors are an excellent choice for the input decoupling of the step-up converter as they have extremely low ESR and are available in small footprints. Input capacitors should be located as close as possible to the device.

Take care when using only ceramic input capacitors. When a ceramic capacitor is used at the input and the power is being supplied through long wires, such as from a wall adapter, a load step at the output can induce ringing at the  $V_{IN}$  pin. This ringing can couple to the output and be mistaken as loop instability or can even damage the part. Place additional "bulk" capacitance (electrolytic or tantalum) in this circumstance, between  $C_{IN}$  and the power source lead, to reduce ringing that can occur between the inductance of the power source leads and  $C_{IN}$ .

### 8.2.2.6 Loop Stability and Compensation

#### 8.2.2.6.1 Small Signal Model

The TPS61372 uses the peak current with adaptive off-time control topology. With the inductor current information sensed, the small-signal model of the power stage reduces from a two-pole system, created by  $L$  and  $C_{OUT}$ , to a single-pole system, created by  $R_{OUT}$  and  $C_{OUT}$ . An external loop compensation network connecting to the COMP pin of TPS61372 is added to optimize the loop stability and the response time, a resistor  $R_C$ , capacitor  $C_C$ , and  $C_P$  shown in Figure 8-2 comprises the loop compensation network.

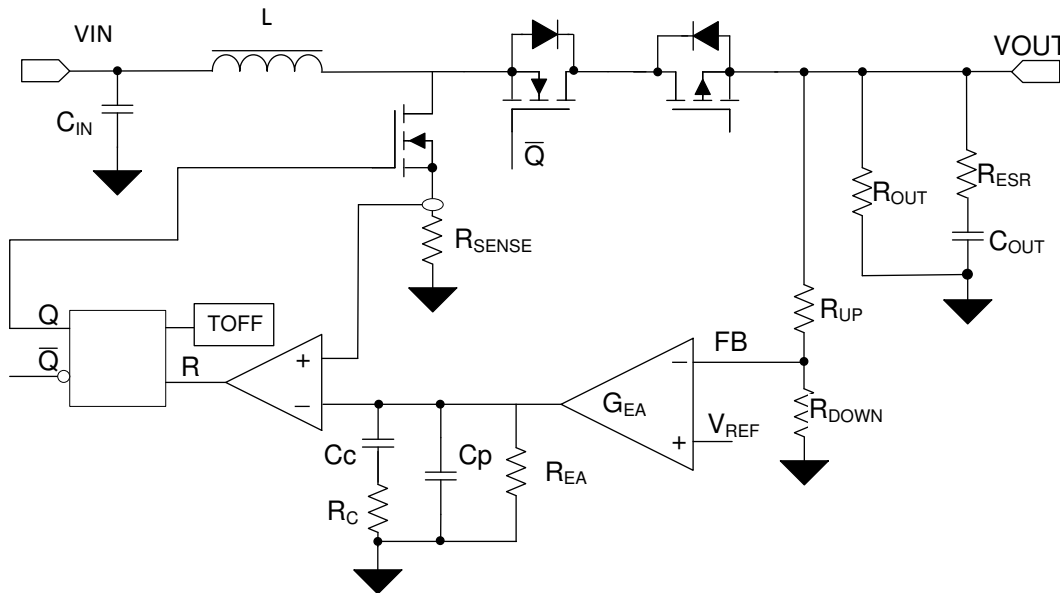

Figure 8-2. TPS61372 Control Equivalent Circuitry Model

The small signal of power stage including the slope compensation is:

$$G_{PS}(S) = \frac{R_{OUT} \times (1-D)}{2 \times R_{SENSE}} \times \frac{\left(1 + \frac{S}{2\pi \times f_{ESR}}\right) \left(1 - \frac{S}{2\pi \times f_{RHP}}\right)}{1 + \frac{S}{2\pi \times f_p}} \quad (11)$$

where

- $D$  is the duty cycle
- $R_{OUT}$  is the output load resistor
- $R_{SENSE}$  is the equivalent internal current sense resistor, which is typically  $0.2 \Omega$  of TPS61372

The single pole of the power stage is:

$$f_p = \frac{2}{2\pi \times R_{OUT} \times C_{OUT}} \quad (12)$$

where

- $C_{OUT}$  is the output capacitance, for a boost converter having multiple, identical output capacitors in parallel, simply combine the capacitors with the equivalent capacitance

The zero created by the ESR of the output capacitor is:

$$f_{ESR} = \frac{1}{2\pi \times R_{ESR} \times C_{OUT}} \quad (13)$$

where

- $R_{ESR}$  is the equivalent resistance in series of the output capacitor

The right-hand plane zero is:

$$f_{RHP} = \frac{R_{OUT} \times (1 - D)^2}{2\pi \times L} \quad (14)$$

where

- $D$  is the duty cycle
- $R_{OUT}$  is the output load resistor
- $L$  is the inductance

The TPS61372 COMP pin is the output of the internal trans-conductance amplifier.

Equation 15 shows the equation for feedback resistor network and the error amplifier.

$$H_{EA}(S) = G_{EA} \times R_{EA} \times \frac{R_{DOWN}}{R_{UP} + R_{DOWN}} \times \frac{1 + \frac{S}{2\pi \times f_z}}{\left(1 + \frac{S}{2\pi \times f_{P1}}\right) \times \left(1 + \frac{S}{2\pi \times f_{P2}}\right)} \quad (15)$$

where

- $R_{EA}$  is the output impedance of the error amplifier  $R_{EA} = 500 \text{ M}\Omega$ .  $G_{EA}$  is the transconductance of the error amplifier,  $G_{EA} = 175 \text{ }\mu\text{S}$ .
- $f_{P1}$ ,  $f_{P2}$  is the pole's frequency of the compensation
- $f_z$  is the zero's frequency of the compensation network

$$f_{P1} = \frac{1}{2\pi \times R_{EA} \times C_c} \quad (16)$$

where

- $C_c$  is the zero capacitor compensation

$$f_{P2} = \frac{1}{2\pi \times R_c \times C_p} \quad (17)$$

where

- $C_p$  is the pole capacitor compensation

- $R_C$  is the resistor of the compensation network

$$f_Z = \frac{1}{2\pi \times R_C \times C_C} \quad (18)$$

### 8.2.2.7 Loop Compensation Design Steps

With the small signal models coming out, the next step is to calculate the compensation network parameters with the given inductor and output capacitance.

#### 1. Set the Crossover Frequency, $f_C$ .

- The first step is to set the loop crossover frequency,  $f_C$ . The higher crossover frequency, the faster the loop response is. It is generally accepted that the loop gain cross over no higher than the lower of either 1/10 of the switching frequency,  $f_{SW}$ , or 1/5 of the RHPZ frequency,  $f_{RHPZ}$ . Then calculate the loop compensation network values of  $R_C$ ,  $C_C$ , and  $C_P$  in following sections.

#### 2. Set the Compensation Resistor, $R_C$ .

- By placing  $f_Z$  below  $f_C$ , for frequencies above  $f_C$ ,  $R_C \parallel R_{EA}$  approximately =  $R_C$ , so  $R_C \times G_{EA}$  sets the compensation gain. Setting the compensation gain,  $K_{COMP-dB}$ , at  $f_Z$ , results in the total loop gain,  $T(s) = G_{PS(s)} \times H_{EA(s)} \times H_e(s)$  being zero at  $f_C$ .
- Therefore, to approximate a single-pole rolloff up to  $f_{P2}$ , rearrange Equation 19 to solve for  $R_C$  so that the compensation gain,  $K_{EA}$ , at  $f_C$  is the negative of the gain,  $K_{PS}$ , read at frequency  $f_C$  for the power stage bode plot or more simply:

$$K_{EA}(f_C) = 20 \times \log(G_{EA} \times R_C \times \frac{R_{DOWN}}{R_{UP} + R_{DOWN}}) = -K_{PS}(f_C) \quad (19)$$

where

- $K_{EA}$  is gain of the error amplifier network
- $K_{PS}$  is the gain of the power stage
- $G_{EA}$  is the transconductance of the amplifier, the typical value of  $G_{EA} = 175 \mu A / V$

#### 3. Set the compensation zero capacitor, $C_C$ .

- Place the compensation zero at the power stage pole position of  $R_{OUT}$ ,  $C_{OUT}$  to get:

$$f_Z = \frac{1}{2\pi \times R_C \times C_C} \quad (20)$$

- Set  $f_Z = f_P$ , and get:

$$C_C = \frac{R_{OUT} \times C_{OUT}}{2R_C} \quad (21)$$

#### 4. Set the compensation pole capacitor, $C_P$ .

- Place the compensation pole at the zero produced by the  $R_{ESR}$  and the  $C_{OUT}$ . It is useful for canceling unhelpful effects of the ESR zero.

$$f_{P2} = \frac{1}{2\pi \times R_C \times C_P} \quad (22)$$

$$f_{ESR} = \frac{1}{2\pi \times R_{ESR} \times C_{OUT}} \quad (23)$$

- Set  $f_{P2} = f_{ESR}$ , and get:

$$C_P = \frac{R_{ESR} \times C_{OUT}}{R_C} \quad (24)$$

- If the calculated value of  $C_P$  is less than 10 pF, it can be neglected.

Designing the loop for greater than 45° of phase margin and greater than 6-dB gain margin eliminates output voltage ringing during the line and load transient. The  $R_C = 61.9 \text{ k}\Omega$ ,  $C_C = 680 \text{ pF}$  for this design example.

### **8.2.2.8 Selecting the Bootstrap Capacitor**

The bootstrap capacitor between the BST and SW pin supplies the gate current to charge the high-side FET device gate during the turnon of each cycle and also supplies charge for the bootstrap capacitor. The recommended value of the bootstrap capacitor is 20 nF to 200 nF.  $C_{BST}$  should be a good quality, low-ESR ceramic capacitor located at the pins of the device to minimize potentially damaging voltage transients caused by trace inductance. A value of 100 nF is selected for this design example.

### 8.2.3 Application Curves

Typical condition  $V_{IN} = 3\text{ V to }5\text{ V}$ ,  $V_{OUT} = 12\text{ V}$ , temperature =  $25^{\circ}\text{C}$ , unless otherwise noted

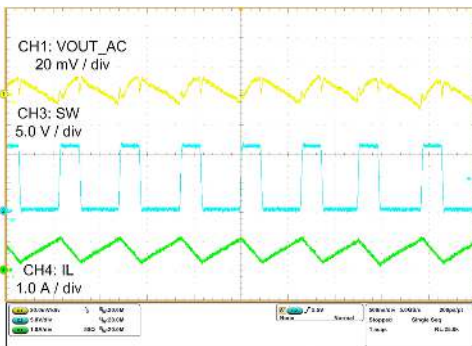

$V_{IN} = 4\text{ V}$        $V_{OUT} = 12\text{ V}$       Mode = Auto PFM  
 $L = 2.2\text{ }\mu\text{H}$        $C_{OUT} = 3 \times 10\text{ }\mu\text{F}$

**Figure 8-3. Steady-State at 200-mA Load**

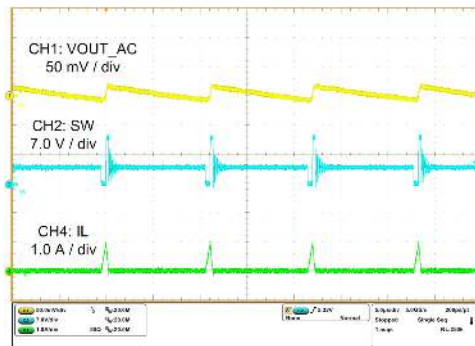

$V_{IN} = 4\text{ V}$        $V_{OUT} = 12\text{ V}$       Mode = Auto PFM  
 $L = 2.2\text{ }\mu\text{H}$        $C_{OUT} = 3 \times 10\text{ }\mu\text{F}$

**Figure 8-4. Steady-State at 10-mA Load**

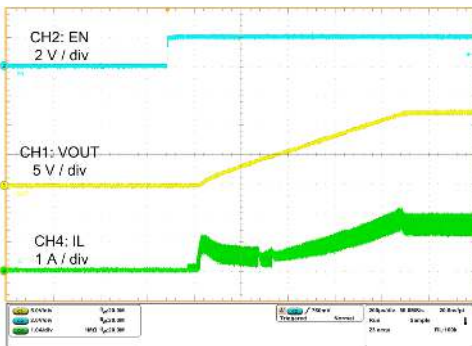

$V_{IN} = 4\text{ V}$        $V_{OUT} = 12\text{ V}$       Mode = Auto PFM  
 $L = 2.2\text{ }\mu\text{H}$        $C_{OUT} = 3 \times 10\text{ }\mu\text{F}$

**Figure 8-5. Start-Up by EN, Load =  $12.5\text{ }\Omega$**

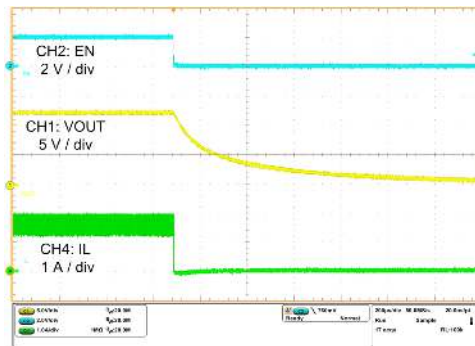

$V_{IN} = 4\text{ V}$        $V_{OUT} = 12\text{ V}$       Mode = Auto PFM  
 $L = 2.2\text{ }\mu\text{H}$        $C_{OUT} = 3 \times 10\text{ }\mu\text{F}$

**Figure 8-6. Shutdown by EN, Load =  $12.5\text{ }\Omega$**

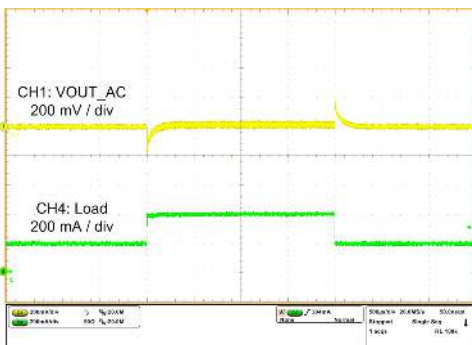

$V_{IN} = 4\text{ V}$        $V_{OUT} = 12\text{ V}$       Mode = Auto PFM  
 $L = 2.2\text{ }\mu\text{H}$        $C_{OUT} = 3 \times 10\text{ }\mu\text{F}$

**Figure 8-7. Load Transient, 200 mA to 400 mA, 100 mA /  $\mu\text{s}$**

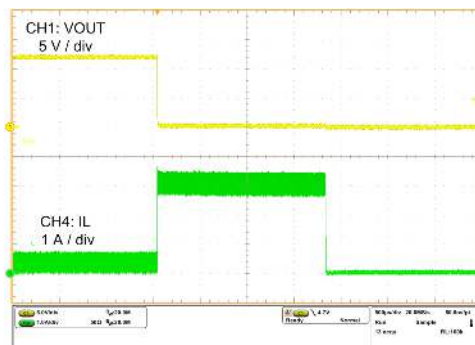

$V_{IN} = 4\text{ V}$        $V_{OUT} = 12\text{ V}$       Mode = Auto PFM  
 $L = 2.2\text{ }\mu\text{H}$        $C_{OUT} = 3 \times 10\text{ }\mu\text{F}$

**Figure 8-8. Shorted Output**

## 9 Power Supply Recommendations

The devices are designed to operate from an input voltage supply ranging from 2.5 V to 5.5 V. This input supply must be well regulated. If the input supply is located more than a few inches from the TPS61372, the bulk capacitance can be required in addition to the ceramic bypass capacitors. An electrolytic capacitor with a value of 47  $\mu\text{F}$  is a typical choice.

## 10 Layout

### 10.1 Layout Guidelines

The basic PCB board layout requires a separation of sensitive signal and power paths. If the layout is not carefully done, the regulator can suffer from the instability or noise problems.

The following checklist is suggested that be followed to get good performance for a well-designed board:

1. Minimize the high current path from output of chip, the output capacitor to the GND of chip. This loop contains high  $di/dt$  switching currents (nano seconds per ampere) and easy to transduce the high frequency noise.
2. Minimize the length and area of all traces connected to the SW pin, and always use a ground plane under the switching regulator to minimize inter plane coupling.
3. Use a combination of bulk capacitors and smaller ceramic capacitors with low series resistance for the input and output capacitors. Place the smaller capacitors closer to the IC to provide a low impedance path for decoupling the noise.
4. The ground area near the IC must provide adequate heat dissipating area. Connect the wide power bus (for example,  $V_{OUT}$ , SW, GND ) to the large area of copper, or to the bottom or internal layer ground plane, using vias for enhanced thermal dissipation.
5. Place the input capacitor being close to the  $V_{IN}$  pin and the PGND pin in order to reduce the input supply ripple.
6. Place the noise sensitive network like the feedback and compensation being far away from the SW trace.
7. Use a separate ground trace to connect the feedback and the loop compensation circuitry. Connect this ground trace to the main power ground at a single point to minimize circulating currents.

### 10.2 Layout Example

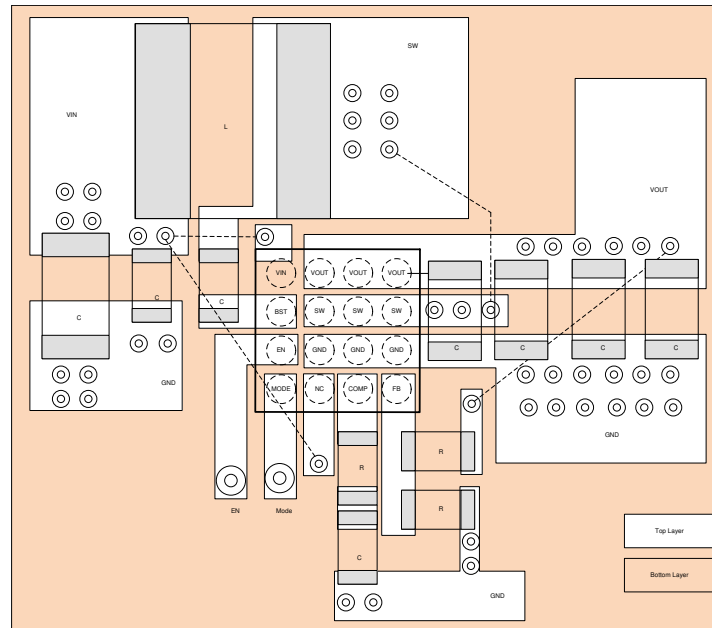

**Figure 10-1. Recommended Layout**

### 10.2.1 Thermal Considerations

Implementation of integrated circuits in low-profile and fine-pitch surface-mount packages typically requires special attention to power dissipation. Many system-dependent issues such as thermal coupling, airflow, added heat sinks and convection surfaces, and the presence of other heat-generating components affect the power dissipation limits of a given component.

Two basic approaches for enhancing thermal performance are listed below:

- Improving the power dissipation capability of the PCB design
- Improving the thermal coupling of the component to the PCB

As power demand in portable designs is more and more important, designers must figure the best trade-off between efficiency, power dissipation and solution size. Due to integration and miniaturization, junction temperature can increase significantly which could lead to bad application behaviors (that is, premature thermal shutdown or worst case reduce device reliability). Junction-to-ambient thermal resistance is highly application and board-layout dependent. In applications where high maximum power dissipation exists, special care must be paid to thermal dissipation issues in board design. Keep the device operating junction temperature ( $T_J$ ) below 125°C.



## 11 Device and Documentation Support

### 11.1 Device Support

#### 11.1.1 Third-Party Products Disclaimer

TI'S PUBLICATION OF INFORMATION REGARDING THIRD-PARTY PRODUCTS OR SERVICES DOES NOT CONSTITUTE AN ENDORSEMENT REGARDING THE SUITABILITY OF SUCH PRODUCTS OR SERVICES OR A WARRANTY, REPRESENTATION OR ENDORSEMENT OF SUCH PRODUCTS OR SERVICES, EITHER ALONE OR IN COMBINATION WITH ANY TI PRODUCT OR SERVICE.

#### 11.1.2 Development Support

##### 11.1.2.1 Custom Design With WEBENCH® Tools

[Click here](#) to create a custom design using the TPS61372 device with the WEBENCH® Power Designer.

1. Start by entering the input voltage ( $V_{IN}$ ), output voltage ( $V_{OUT}$ ), and output current ( $I_{OUT}$ ) requirements.
2. Optimize the design for key parameters such as efficiency, footprint, and cost using the optimizer dial.
3. Compare the generated design with other possible solutions from Texas Instruments.

The WEBENCH Power Designer provides a customized schematic along with a list of materials with real-time pricing and component availability.

In most cases, these actions are available:

- Run electrical simulations to see important waveforms and circuit performance
- Run thermal simulations to understand board thermal performance
- Export customized schematic and layout into popular CAD formats
- Print PDF reports for the design, and share the design with colleagues

Get more information about WEBENCH tools at [www.ti.com/WEBENCH](http://www.ti.com/WEBENCH).

### 11.2 Receiving Notification of Documentation Updates

To receive notification of documentation updates, navigate to the device product folder on [ti.com](http://ti.com). Click on *Subscribe to updates* to register and receive a weekly digest of any product information that has changed. For change details, review the revision history included in any revised document.

### 11.3 Support Resources

[TI E2E™ support forums](#) are an engineer's go-to source for fast, verified answers and design help — straight from the experts. Search existing answers or ask your own question to get the quick design help you need.

Linked content is provided "AS IS" by the respective contributors. They do not constitute TI specifications and do not necessarily reflect TI's views; see TI's [Terms of Use](#).

### 11.4 Trademarks

TI E2E™ is a trademark of Texas Instruments.

WEBENCH® is a registered trademark of Texas Instruments.

All trademarks are the property of their respective owners.

### 11.5 Electrostatic Discharge Caution



This integrated circuit can be damaged by ESD. Texas Instruments recommends that all integrated circuits be handled with appropriate precautions. Failure to observe proper handling and installation procedures can cause damage.

ESD damage can range from subtle performance degradation to complete device failure. Precision integrated circuits may be more susceptible to damage because very small parametric changes could cause the device not to meet its published specifications.



### 11.6 Glossary

[TI Glossary](#) This glossary lists and explains terms, acronyms, and definitions.

## 12 Mechanical, Packaging, and Orderable Information

The following pages include mechanical, packaging, and orderable information. This information is the most current data available for the designated devices. This data is subject to change without notice and revision of this document. For browser-based versions of this data sheet, refer to the left-hand navigation.

**PACKAGING INFORMATION**

Orderable Device	Status (1)	Package Type	Package Drawing	Pins	Package Qty	Eco Plan (2)	Lead finish/ Ball material (6)	MSL Peak Temp (3)	Op Temp (°C)	Device Marking (4/5)	Samples
TPS61372YKBR	ACTIVE	DSBGA	YKB	16	3000	RoHS & Green	SNAGCU	Level-1-260C-UNLIM	-40 to 125	TPS 61372	
TPS61372YKBT	ACTIVE	DSBGA	YKB	16	250	RoHS & Green	SNAGCU	Level-1-260C-UNLIM	-40 to 125	TPS 61372	

(1) The marketing status values are defined as follows:

**ACTIVE:** Product device recommended for new designs.

**LIFEBUY:** TI has announced that the device will be discontinued, and a lifetime-buy period is in effect.

**NRND:** Not recommended for new designs. Device is in production to support existing customers, but TI does not recommend using this part in a new design.

**PREVIEW:** Device has been announced but is not in production. Samples may or may not be available.

**OBSOLETE:** TI has discontinued the production of the device.

(2) **RoHS:** TI defines "RoHS" to mean semiconductor products that are compliant with the current EU RoHS requirements for all 10 RoHS substances, including the requirement that RoHS substance do not exceed 0.1% by weight in homogeneous materials. Where designed to be soldered at high temperatures, "RoHS" products are suitable for use in specified lead-free processes. TI may reference these types of products as "Pb-Free".

**RoHS Exempt:** TI defines "RoHS Exempt" to mean products that contain lead but are compliant with EU RoHS pursuant to a specific EU RoHS exemption.

**Green:** TI defines "Green" to mean the content of Chlorine (Cl) and Bromine (Br) based flame retardants meet JS709B low halogen requirements of <=1000ppm threshold. Antimony trioxide based flame retardants must also meet the <=1000ppm threshold requirement.

(3) MSL, Peak Temp. - The Moisture Sensitivity Level rating according to the JEDEC industry standard classifications, and peak solder temperature.

(4) There may be additional marking, which relates to the logo, the lot trace code information, or the environmental category on the device.

(5) Multiple Device Markings will be inside parentheses. Only one Device Marking contained in parentheses and separated by a "~" will appear on a device. If a line is indented then it is a continuation of the previous line and the two combined represent the entire Device Marking for that device.

(6) Lead finish/Ball material - Orderable Devices may have multiple material finish options. Finish options are separated by a vertical ruled line. Lead finish/Ball material values may wrap to two lines if the finish value exceeds the maximum column width.

**Important Information and Disclaimer:**The information provided on this page represents TI's knowledge and belief as of the date that it is provided. TI bases its knowledge and belief on information provided by third parties, and makes no representation or warranty as to the accuracy of such information. Efforts are underway to better integrate information from third parties. TI has taken and continues to take reasonable steps to provide representative and accurate information but may not have conducted destructive testing or chemical analysis on incoming materials and chemicals. TI and TI suppliers consider certain information to be proprietary, and thus CAS numbers and other limited information may not be available for release.

In no event shall TI's liability arising out of such information exceed the total purchase price of the TI part(s) at issue in this document sold by TI to Customer on an annual basis.



## TAPE AND REEL INFORMATION



### QUADRANT ASSIGNMENTS FOR PIN 1 ORIENTATION IN TAPE



\*All dimensions are nominal

Device	Package Type	Package Drawing	Pins	SPQ	Reel Diameter (mm)	Reel Width W1 (mm)	A0 (mm)	B0 (mm)	K0 (mm)	P1 (mm)	W (mm)	Pin1 Quadrant
TPS61372YKBR	DSBGA	YKB	16	3000	180.0	8.4	1.68	1.72	0.62	4.0	8.0	Q1
TPS61372YKBT	DSBGA	YKB	16	250	180.0	8.4	1.68	1.72	0.62	4.0	8.0	Q1

**TAPE AND REEL BOX DIMENSIONS**

\*All dimensions are nominal

Device	Package Type	Package Drawing	Pins	SPQ	Length (mm)	Width (mm)	Height (mm)
TPS61372YKBR	DSBGA	YKB	16	3000	182.0	182.0	20.0
TPS61372YKBT	DSBGA	YKB	16	250	182.0	182.0	20.0

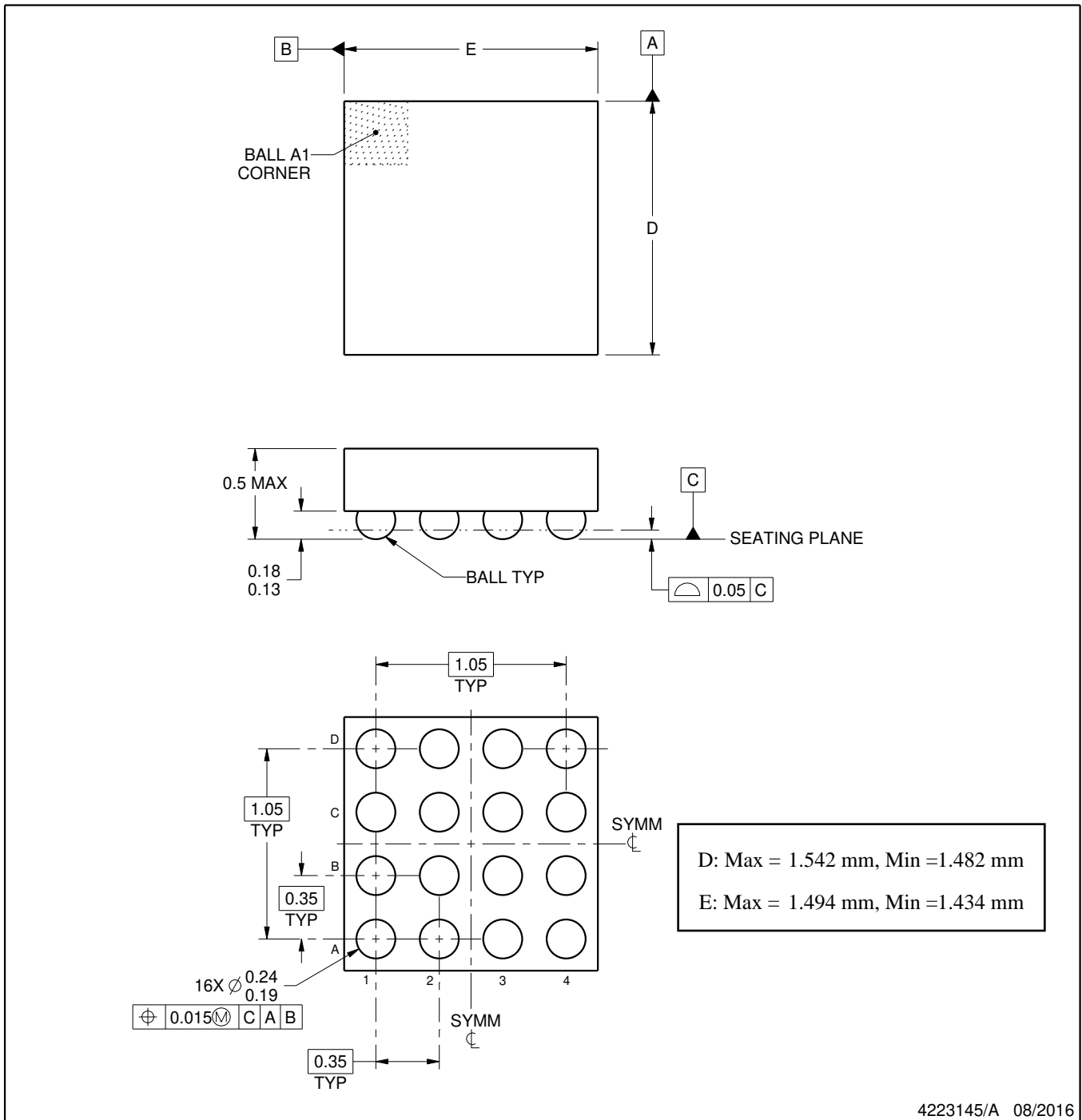
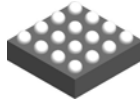

NOTES:

1. All linear dimensions are in millimeters. Any dimensions in parenthesis are for reference only. Dimensioning and tolerancing per ASME Y14.5M.
2. This drawing is subject to change without notice.

# EXAMPLE BOARD LAYOUT

YKB0016

DSBGA - 0.5 mm max height

DIE SIZE BALL GRID ARRAY

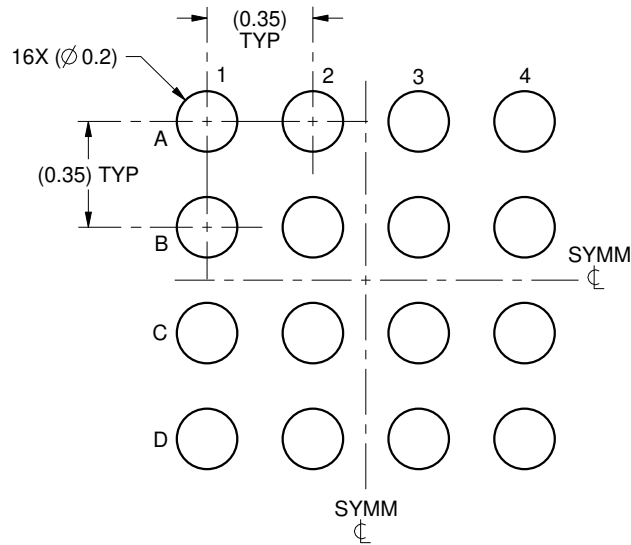

LAND PATTERN EXAMPLE  
SCALE:40X

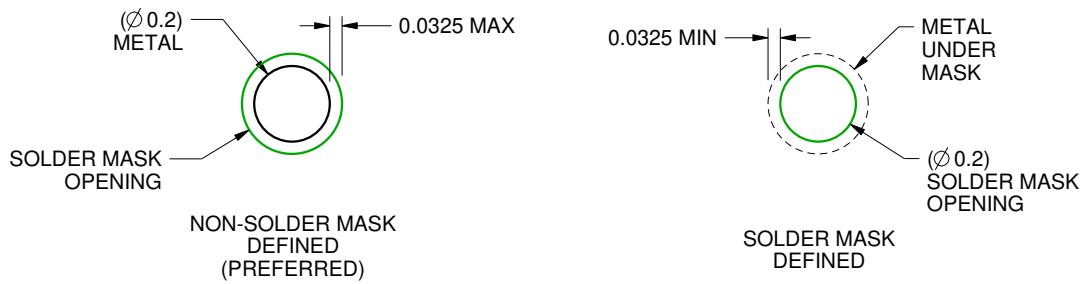

SOLDER MASK DETAILS  
NOT TO SCALE

4223145/A 08/2016

NOTES: (continued)

- Final dimensions may vary due to manufacturing tolerance considerations and also routing constraints. See Texas Instruments Literature No. SNVA009 ([www.ti.com/lit/snva009](http://www.ti.com/lit/snva009)).



# EXAMPLE STENCIL DESIGN

YKB0016

DSBGA - 0.5 mm max height

DIE SIZE BALL GRID ARRAY

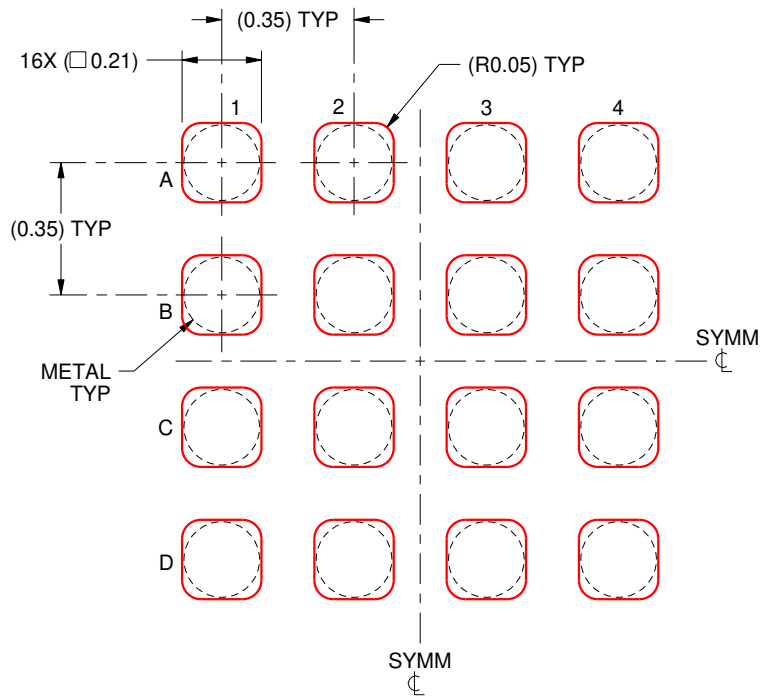

SOLDER PASTE EXAMPLE  
BASED ON 0.075 - 0.1mm THICK STENCIL  
SCALE:50X

4223145/A 08/2016

NOTES: (continued)

4. Laser cutting apertures with trapezoidal walls and rounded corners may offer better paste release.

## IMPORTANT NOTICE AND DISCLAIMER

TI PROVIDES TECHNICAL AND RELIABILITY DATA (INCLUDING DATA SHEETS), DESIGN RESOURCES (INCLUDING REFERENCE DESIGNS), APPLICATION OR OTHER DESIGN ADVICE, WEB TOOLS, SAFETY INFORMATION, AND OTHER RESOURCES "AS IS" AND WITH ALL FAULTS, AND DISCLAIMS ALL WARRANTIES, EXPRESS AND IMPLIED, INCLUDING WITHOUT LIMITATION ANY IMPLIED WARRANTIES OF MERCHANTABILITY, FITNESS FOR A PARTICULAR PURPOSE OR NON-INFRINGEMENT OF THIRD PARTY INTELLECTUAL PROPERTY RIGHTS.

These resources are intended for skilled developers designing with TI products. You are solely responsible for (1) selecting the appropriate TI products for your application, (2) designing, validating and testing your application, and (3) ensuring your application meets applicable standards, and any other safety, security, regulatory or other requirements.

These resources are subject to change without notice. TI grants you permission to use these resources only for development of an application that uses the TI products described in the resource. Other reproduction and display of these resources is prohibited. No license is granted to any other TI intellectual property right or to any third party intellectual property right. TI disclaims responsibility for, and you will fully indemnify TI and its representatives against, any claims, damages, costs, losses, and liabilities arising out of your use of these resources.

TI's products are provided subject to [TI's Terms of Sale](#) or other applicable terms available either on [ti.com](https://www.ti.com) or provided in conjunction with such TI products. TI's provision of these resources does not expand or otherwise alter TI's applicable warranties or warranty disclaimers for TI products.

TI objects to and rejects any additional or different terms you may have proposed.

Mailing Address: Texas Instruments, Post Office Box 655303, Dallas, Texas 75265  
Copyright © 2023, Texas Instruments Incorporated