

ISL9205, ISL9205A, ISL9205B, ISL9205C, ISL9205D

Li-ion Battery Charger

FN9252
Rev 4.00
Dec 20, 2018

The [ISL9205](#), [ISL9205A](#), [ISL9205B](#), [ISL9205C](#), and [ISL9205D](#) are integrated single-cell Li-ion or Li-polymer chargers capable of operating at an input voltage as low as 2.5V. The low operating voltage allows the charger to work with a variety of AC adapters.

The ISL9205 family operates as a linear charger when the AC adapter is a voltage source. The battery is charged in a standard Li-ion charge profile, that is, a Constant Current phase followed by a Constant Voltage phase (CC/CV). The charge current during the Constant Current phase is determined by the external resistor connected to the IREF pin. When the adapter output is a current-limited voltage source and the current limit is smaller than the programmed constant current of the IC, the ISL9205 operates as a pulse charger where the charge current is determined by the current limit of the AC adapter during the Constant Current phase. The ISL9205 operates in a linear mode during the constant voltage phase in both adapter cases.

The ISL9205 family incorporates Thermaguard, which protects the IC against over-temperature. If the die temperature rises above a typical value of +100°C, the thermal foldback function reduces the charge current to prevent further temperature rise. The ISL9205 includes an external temperature monitoring function (not available in some package options). A Negative Temperature Coefficient (NTC) thermistor is connected between the TEMP pin and GND to monitor the battery or ambient temperature. The ISL9205 also includes a timer to set the time reference for various charge time limits. The timer is programmable with an external capacitor. Two logic inputs and two open-drain logic outputs are available for controlling the charger and indicating the charger status. The EN pin enables the charger. The TOEN pin (available in the ISL9205) enables the timeout function so that the charge is terminated when the preset time limits have been reached. The FAULT pin is an open-drain output that turns on when a fault condition is encountered. The STATUS pin is also an open-drain output that turns on when the charger is delivering current.

Features

- Complete charger for single-cell Li-ion/polymer batteries
- Integrated pass element and current sensor
- No external blocking diode required
- Low component count and cost
- 25mV voltage accuracy over-temperature and input voltage range
- 15mV voltage accuracy at room temperature
- Programmable charge current
- **Programmable end-of-charge current (ISL9205)**
- **Charge current thermal foldback for thermal protection (Thermaguard)**
- Trickle charge for fully discharged batteries
- Power presence and charge indications
- NTC interface (not available in some package options)
- Less than 3µA leakage current off the battery when no input power attached or charger disabled
- Ambient temperature range: -40°C to +85°C
- DFN, QFN packages
- Pb-free (RoHS compliant)

Applications

- Mobile phones
- Bluetooth devices
- PDAs
- MP3 players
- Stand-alone cradle or travel chargers
- Other handheld devices

Related Literature

- For a full list of related documents, visit our website:
 - [ISL9205](#), [ISL9205A](#), [ISL9205B](#), [ISL9205C](#), [ISL9205D](#) device pages

Ordering Information

PART NUMBER (Notes 2, 3)	PART MARKING	TEMP. RANGE (°C)	V _{BAT} (V)	VSEN	TEMP	TIMEOUT	TAPE AND REEL (Units) (Note 1)	PACKAGE (RoHS COMPLIANT)	PKG DWG. #
ISL9205IRZ	DLBA	-40 to +85	4.2	Yes	Yes	Yes	-	16 Ld 3x3 QFN	L16.3x3B
ISL9205IRZ-T	DLBA	-40 to +85	4.2	Yes	Yes	Yes	6k	16 Ld 3x3 QFN	L16.3x3B
ISL9205AIRZ	DLCA	-40 to +85	4.2	Yes	No	No	-	10 Ld 3x3 DFN	L10.3x3
ISL9205AIRZ-T	DLCA	-40 to +85	4.2	Yes	No	No	6k	10 Ld 3x3 DFN	L10.3x3
ISL9205BIRZ	DLDA	-40 to +85	4.2	Yes	No	Yes	-	10 Ld 3x3 DFN	L10.3x3
ISL9205BIRZ-T	DLDA	-40 to +85	4.2	Yes	No	Yes	6k	10 Ld 3x3 DFN	L10.3x3
ISL9205CIRZ	DLEA	-40 to +85	4.256	Yes	No	Yes	-	10 Ld 3x3 DFN	L10.3x3
ISL9205CIRZ-T	DLEA	-40 to +85	4.256	Yes	No	Yes	6k	10 Ld 3x3 DFN	L10.3x3
ISL9205DIRZ	DLFA	-40 to +85	4.2	No	Yes	Yes	-	10 Ld 3x3 DFN	L10.3x3
ISL9205DIRZ-T	DLFA	-40 to +85	4.2	No	Yes	Yes	6k	10 Ld 3x3 DFN	L10.3x3
ISL9205EVAL1Z	Evaluation board								
ISL9205AEVAL1Z	Evaluation board								
ISL9205BEVAL1Z	Evaluation board								
ISL9205CEVAL1Z	Evaluation board								
ISL9205DEVAL1Z	Evaluation board								

NOTES:

1. See [TB347](#) for details about reel specifications.
2. Pb-free plus anneal products employ special Pb-free material sets; molding compounds/die attach materials and 100% matte tin plate termination finish, which are RoHS compliant and compatible with both SnPb and Pb-free soldering operations. Pb-free products are MSL classified at Pb-free peak reflow temperatures that meet or exceed the Pb-free requirements of IPC/JEDEC J STD-020.
3. For Moisture Sensitivity Level (MSL), see [ISL9205](#), [ISL9205A](#), [ISL9205B](#), [ISL9205C](#), [ISL9205D](#) device pages. For more information about MSL, see [TB363](#).

Pin Configurations

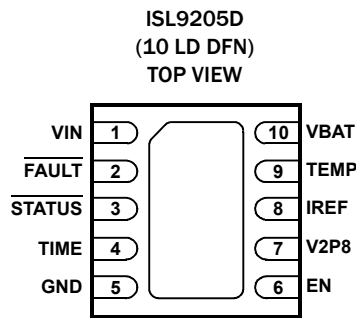
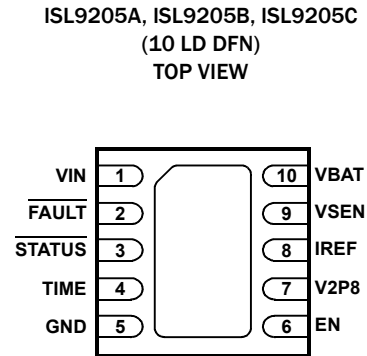
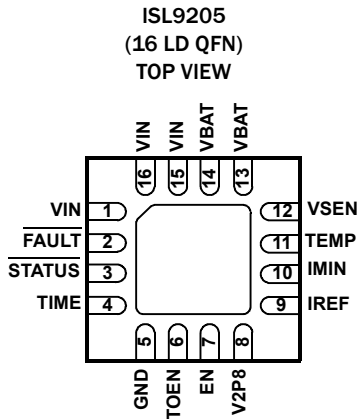

Pin Descriptions

PIN NAME	ISL9205	ISL9205A, ISL9205B, ISL9205C	ISL9205D	DESCRIPTION
VIN	1, 15, 16	1	1	Input power source. Connect to a wall adapter.
FAULT	2	2	2	Open-drain output indicating fault status. This pin is pulled to LOW under any fault condition. When a fault condition occurs, the time counter resets. When the charger is disabled, the FAULT pin outputs high impedance.
STATUS	3	3	3	Open-drain output indicating charging and inhibit states. This pin is pulled LOW when the charger is charging a battery. It turns into high impedance when the charge current drops to IMIN. This high impedance state is latched until a recharge cycle or a new charge cycle starts. When the charger is disabled, the STATUS pin outputs high impedance.
TIME	4	4	4	Determines the oscillation period by connecting a timing capacitor between this pin and GND. The oscillator also provides a time reference for the charger.
GND	5	5	5	Connection to system ground.
TOEN	6	-	-	TIMEOUT enable input pin. Pulling this pin to LOW disables the TIMEOUT charge-time limit for the fast charge modes. Leaving this pin HIGH or floating enables the TIMEOUT limit. There is an internal 400kΩ pull-up resistor at this pin.
EN	7	6	6	Enable logic input. Connect the EN pin to LOW to disable the charger or leave it floating to enable the charger. There is an internal 400kΩ pull-up resistor at this pin.
V2P8	8	7	7	2.8V reference voltage output. This pin provides a 2.8V voltage source when the input voltage is above the POR threshold and outputs zero otherwise. The V2P8 pin can be used as an indication for adapter presence.

Pin Descriptions (Continued)

PIN NAME	ISL9205	ISL9205A, ISL9205B, ISL9205C	ISL9205D	DESCRIPTION
IREF	9	8	8	<p>Charge current programming and monitoring pin. Connect a resistor between this pin and GND to set the charge current during the Constant Current phase, as given by Equation 1:</p> $I_{REF} = \frac{80}{R_{IREF}} \quad (\text{A}) \quad (\text{EQ. 1})$ <p>where R_{IREF} is in kΩ.</p>
TEMP	11	-	9	Input for an external NTC thermistor. The TEMP pin is also used for battery removal detection.
IMIN	10	-	-	<p>End-of-Charge (EOC) current programming pin. Connect a resistor between this pin and GND to set the EOC current, as given by Equation 2:</p> $I_{MIN} = \frac{8000}{R_{IMIN}} \quad (\text{mA}) \quad (\text{EQ. 2})$ <p>where R_{IMIN} is in kΩ.</p>
VSEN	12	9	-	Remote voltage sense pin. Connect this pin as close to the battery positive terminal as possible. If the VSEN pin is left floating, its voltage drops to zero volt and the charger operates in Trickle mode.
VBAT	13, 14	10	10	Connection to the battery. Typically a ceramic capacitor of minimum 1 μ F is needed for stability when there is no battery attached. When a battery is attached, only a 0.1 μ F ceramic capacitor is required.

Typical Applications

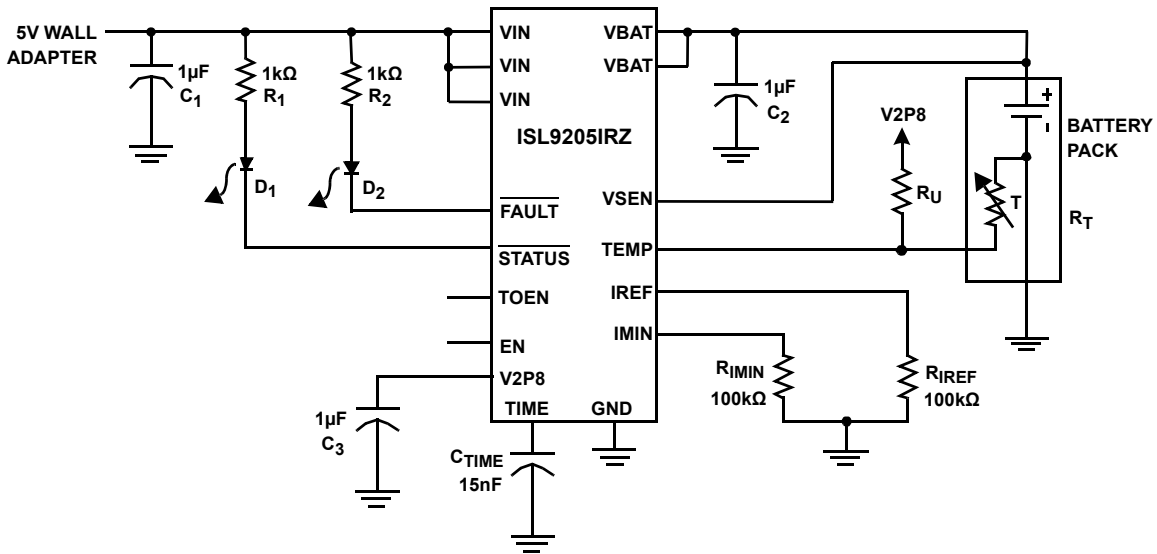

FIGURE 1. TYPICAL APPLICATION: 3x3 QFN PACKAGE OPTION

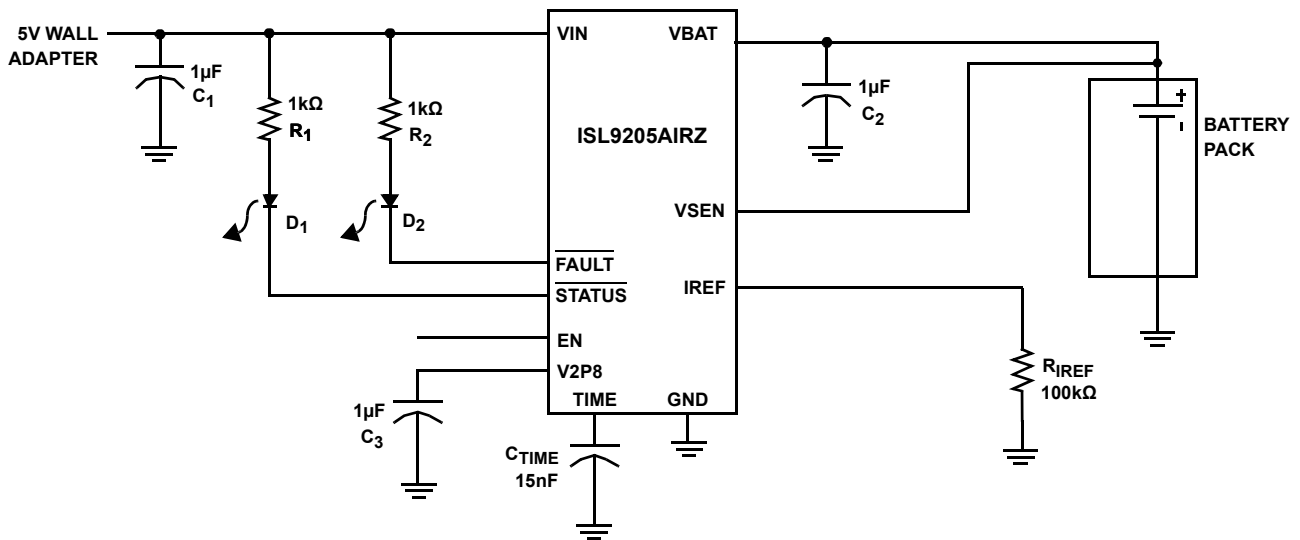

FIGURE 2. TYPICAL APPLICATION: 3x3 DFN PACKAGE OPTION

Absolute Maximum Ratings

Voltage Ratings for All Pins	-0.3V to 7V
Charge Current	1.0A
ESD Rating	
Human Body Model	2kV
Machine Model	200V

Thermal Information

Thermal Resistance	θ_{JA} (°C/W)	θ_{JC} (°C/W)
3x3 DFN Package (Note 4)	48	6
3x3 QFN Package (Note 5)	54	6
Maximum Junction Temperature (Plastic Package)	+150°C	
Maximum Storage Temperature Range	-65°C to +150°C	
Pb-Free Reflow Profile	see TB493	

Recommended Operating Conditions

Ambient Temperature Range	-40°C to +85°C
Operating Supply Voltage (VIN Pin)	4.25V to 6.5V
Programmed Charge Current	50mA to 900mA

CAUTION: Stresses above those listed in "Absolute Maximum Ratings" can cause permanent damage to the device. This is a stress only rating and operation of the device at these or any other conditions above those indicated in the operational sections of this specification is not implied.

The 150°C maximum junction temperature is for information purposes only. In reality, the current foldback feature prevents the junction from rising above a worst case temperature of 125°C.

NOTES:

- θ_{JA} is measured in free air with the component mounted on a high-effective thermal conductivity test board with "direct attach" features. See [TB379](#).
- For θ_{JC} , the "case temp" location is the center of the exposed metal pad on the package underside.

Electrical Specifications

Typical values are tested at $V_{IN} = 5V$ and the ambient temperature at +25°C, unless otherwise noted.

PARAMETER	SYMBOL	TEST CONDITIONS	MIN	TYP	MAX	UNIT
POWER-ON RESET						
Rising POR Threshold	V_{POR}	$V_{BAT} = 3.0V$, use V2P8 pin to indicate the comparator output.	3.2	3.6	3.9	V
Falling POR Threshold	V_{POR}		2.25	2.5	2.7	V
VIN-BAT OFFSET VOLTAGE						
Rising Edge	V_{OS}	$V_{BAT} = 4.2V$, $I_{BAT} = 20mA$, use STATUS pin to indicate the comparator output (Note 6)	45	80	100	mV
STANDBY CURRENT						
BAT Pin Sink Current	$I_{STANDBY}$	Charger disabled or the input is floating	-	-	3.3	μA
VIN Pin Supply Current	I_{VIN}	Charger disabled	-	150	250	μA
VIN Pin Supply Current	I_{VIN}	Charger enabled	-	1.0	-	mA
VOLTAGE REGULATION						
Output Voltage (Except ISL9205C)	V_{CH}	Tested at 50mA load, 5V input, and +25°C	4.185	4.20	4.215	V
	V_{CH}	-40°C < T_A < +85°C, 4.3V < V_{IN} < 6.5V	4.175	4.20	4.225	V
Output Voltage (ISL9205C)	V_{CH}	Tested at 50mA load, 5V input, and +25°C	4.241	4.256	4.271	V
	V_{CH}	-40°C < T_A < +85°C, 4.3V < V_{IN} < 6.5V	4.231	4.256	4.281	V
PMOS ON-Resistance	$r_{DS(ON)}$	$V_{BAT} = 4.0V$, charge current = 0.35A	-	500	-	$\mu\Omega$
CHARGE CURRENT (Note 7)						
Constant Charge Current	I_{CC}	$R_{IREF} = 100k\Omega$, $V_{BAT} = 3.0V$ to 4.0V	760	800	840	mA
Trickle Charge Current	I_{TRK}	$R_{IREF} = 100k\Omega$, $V_{BAT} = 0V$ to 2.5V	64	80	96	mA
End-of-Charge Current	I_{MIN}	$R_{IREF} = 100k\Omega$ (ISL9205)	70	80	90	mA
End-of-Charge Current	I_{MIN}	$R_{IREF} = 100k\Omega$ (ISL9205A, ISL9205B, ISL9205C and ISL9205D)	70	80	90	mA
V2P8 PIN OUTPUT						
V2P8 Pin Output Voltage	V_{V2P8}	Load current less than 1mA	2.8	2.9	3.0	V

Electrical Specifications Typical values are tested at $V_{IN} = 5V$ and the ambient temperature at $+25^{\circ}C$, unless otherwise noted.

PARAMETER	SYMBOL	TEST CONDITIONS	MIN	TYP	MAX	UNIT
CHARGE THRESHOLDS						
Preconditioning Charge Threshold Voltage	V_{MIN}		2.7	2.8	2.9	V
Preconditioning Voltage Hysteresis	V_{MINHYS}		50	100	150	mV
Recharge Threshold	V_{RCH}	Referenced to the charger output voltage V_{CH}	-225	-150	-70	mV
Recharge Threshold Hysteresis	V_{RCHHYS}		-	50	-	mV
INTERNAL TEMPERATURE MONITORING						
Charge Current Foldback Threshold	T_{FOLD}		-	110	-	$^{\circ}C$
AMBIENT TEMPERATURE MONITORING (ISL9205 and ISL9205D)						
High Voltage Threshold		$V_{2P8} = 3.0V$	1.98	2.0	2.02	V
High Voltage Threshold Hysteresis		$V_{2P8} = 3.0V$	-	1.9	-	V
Low Voltage Threshold		$V_{2P8} = 3.0V$	0.99	1	1.01	V
Low Voltage Threshold Hysteresis		$V_{2P8} = 3.0V$	-	1.1	-	V
OSCILLATOR						
Oscillation Period	t_{OSC}	$C_{TIME} = 15nF$	2.7	3.0	3.3	ms
LOGIC INPUT AND OUTPUTS						
EN/TOEN Pin Logic Input High			1.3	-	-	V
EN/TOEN Pin Logic Input Low			-	-	0.5	V
EN/TOEN Pin Internal Pull-Up Resistance			200	400	600	k Ω
STATUS/FAULT Output Voltage when On		10mA current	-	-	0.8	V
STATUS/FAULT Leakage Current		$V_{STATUS} = 6.5V$	-	-	1	μA

NOTES:

- The 4.2V V_{BAT} is selected so that the \overline{STATUS} output can be used as the indication for the offset comparator output indication. If the V_{BAT} is lower than the POR threshold, no output pin can be used for indication.
- The charge current can be affected by the thermal foldback function if the IC under the test setup cannot dissipate the heat.

Typical Operating Performance

unless otherwise noted.

Test conditions are: $V_{IN} = 5V$, $T_A = +25^\circ C$, $R_{IREF} = R_{IMIN} = 100k\Omega$, $V_{BAT} = 3.7V$,

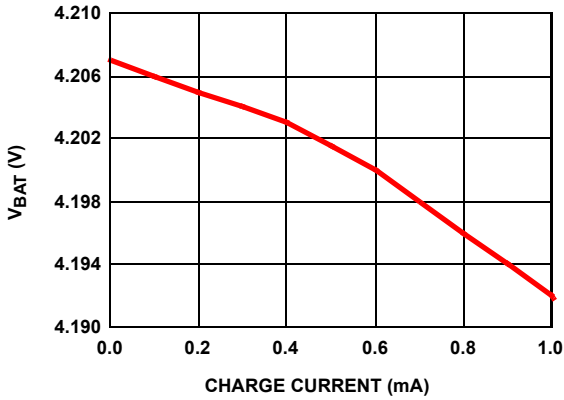

FIGURE 3. CHARGER OUTPUT VOLTAGE vs CHARGE CURRENT

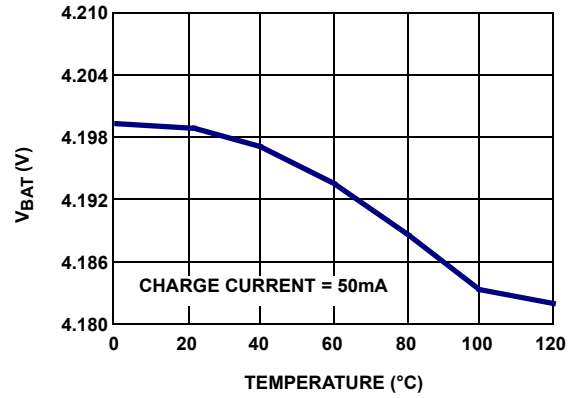

FIGURE 4. CHARGER OUTPUT VOLTAGE vs TEMPERATURE

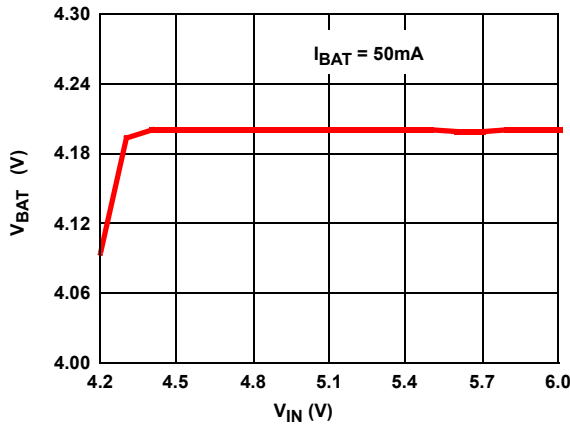

FIGURE 5. CHARGER OUTPUT VOLTAGE vs INPUT VOLTAGE
CHARGE CURRENT IS 50mA

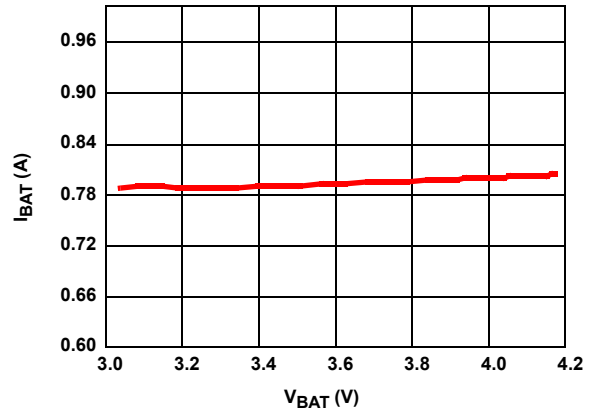

FIGURE 6. CHARGE CURRENT vs OUTPUT VOLTAGE

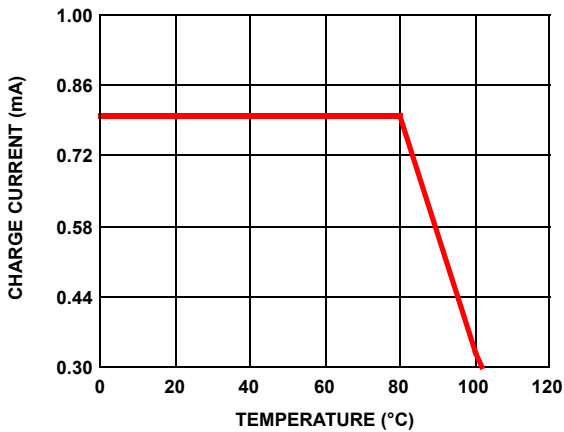

FIGURE 7. CHARGE CURRENT vs AMBIENT TEMPERATURE

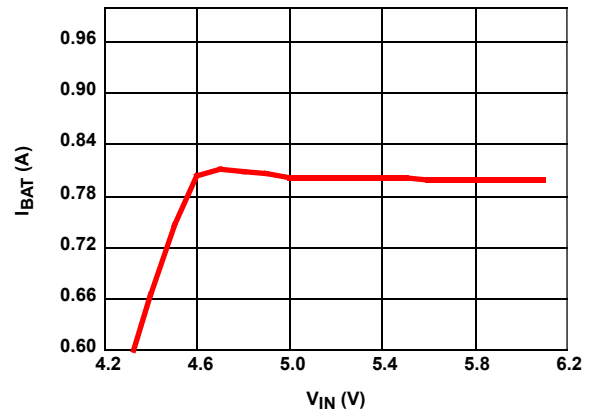

FIGURE 8. CHARGE CURRENT vs INPUT VOLTAGE

Typical Operating Performance

unless otherwise noted. (Continued)

Test conditions are: $V_{IN} = 5V$, $T_A = +25^\circ C$, $R_{IREF} = R_{IMIN} = 100k\Omega$, $V_{BAT} = 3.7V$,

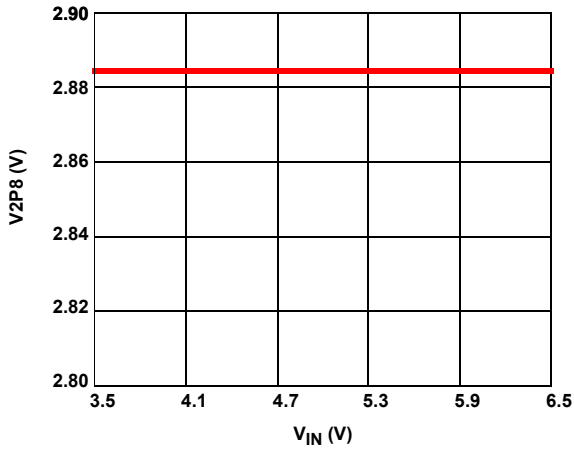

FIGURE 9. V2P8 OUTPUT vs INPUT VOLTAGE

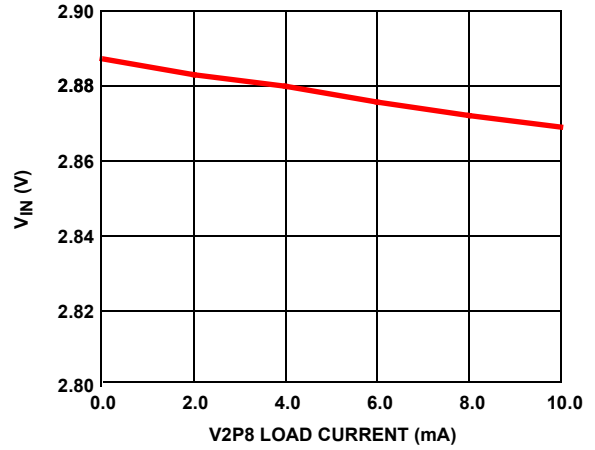

FIGURE 10. V2P8 OUTPUT vs ITS LOAD CURRENT

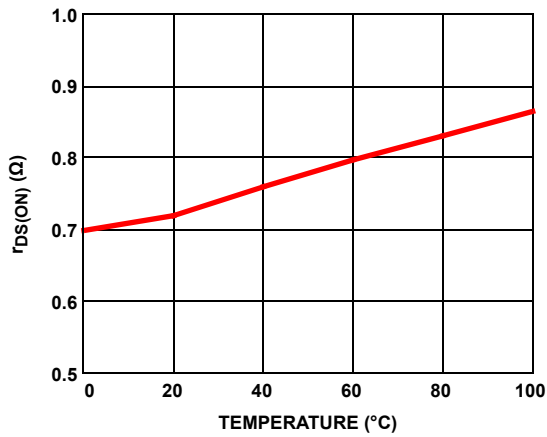

FIGURE 11. $r_{DS(ON)}$ vs TEMPERATURE AT 3.7V OUTPUT

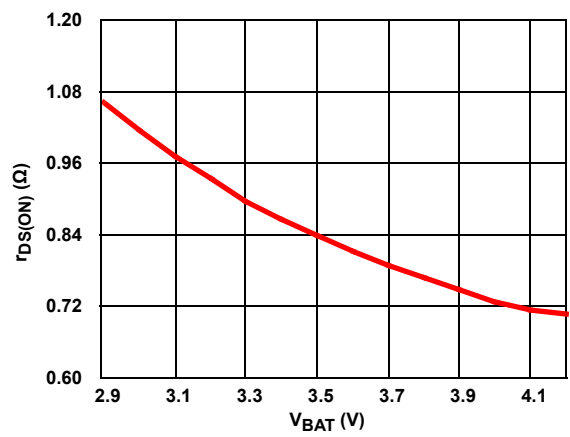

FIGURE 12. $r_{DS(ON)}$ vs OUTPUT VOLTAGE USING CURRENT LIMITED ADAPTERS

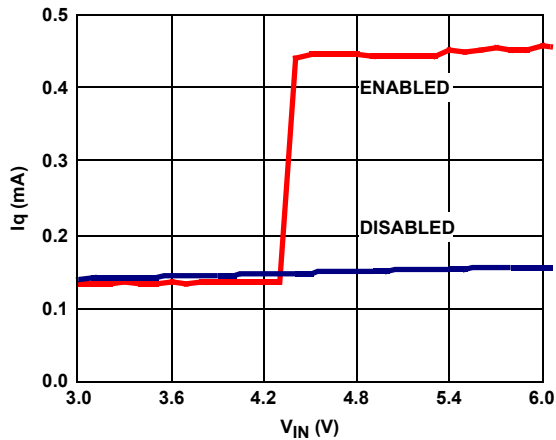

FIGURE 13. INPUT QUIESCENT CURRENT vs INPUT VOLTAGE

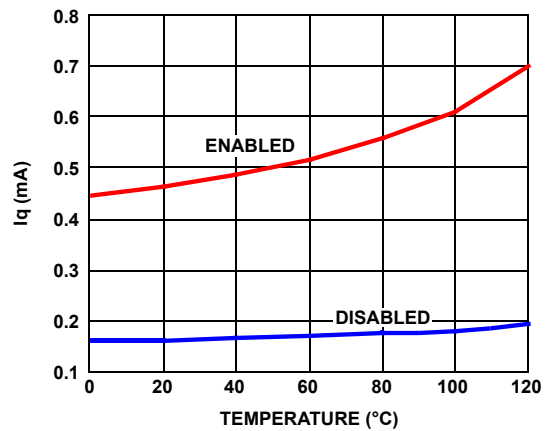

FIGURE 14. INPUT QUIESCENT CURRENT vs TEMPERATURE

Theory of Operation

The ISL9205 family are integrated chargers for single-cell Li-ion or Li-polymer batteries. They are capable of operating in two operation modes, Linear Charge mode and Pulse Charge mode. They function as traditional linear chargers when powered with a voltage source adapter. When powered with a current-limited adapter, the chargers function as pulse chargers by fully turning on the pass element, thereby reducing the power dissipation.

Constant Current Phase

The ISL9205 family starts the charge at a Constant Current (CC) phase. The charge current is regulated to fast charge the battery before the final voltage has been reached. The charge current is programmable with the IREF pin and has two operation modes: Trickle mode and Constant Current mode, depending on the battery voltage. When the battery voltage is lower than 2.8V, the charger operates in Trickle mode where the charge current is set at 10% of the Constant Current mode current. Trickle mode is for preconditioning a deeply discharged battery. When the battery voltage is above the typical 2.8V threshold, the Constant Current mode starts. The constant current is programmable between 50mA to 1A.

Constant Voltage Phase

When the battery reaches the final voltage, the ISL9205 switches the operation to a Constant Voltage (CV) phase. The output voltage is regulated at the final voltage value. During the Constant Voltage phase, the charge current reduces gradually as the cell voltage rises.

End-of-Charge and Recharge

As the charge current reaches the End-of-Charge (EOC) current threshold during the Constant Voltage phase, the $\overline{\text{STATUS}}$ pin open-drain FET is turned off to indicate an EOC condition. The EOC current is programmable for the ISL9205 by connecting a resistor from the IMIN pin to GND. For ISL9205A, ISL9205B, ISL9205C, and ISL9205D, the EOC current is fixed at 10% of the programmed constant charge current. When the $\overline{\text{STATUS}}$ pin indicates the EOC condition, the charger continues to charge until the EN pin is pulled to logic LOW or the input power has been removed. After EOC is reached, recharge occurs when the battery voltage falls to 150mV below the constant voltage value. The $\overline{\text{STATUS}}$ open-drain FET is turned on when a recharge condition is met. An internal delay is implemented at the $\overline{\text{STATUS}}$ pin for both EOC and recharge conditions to prevent nuisance trips due to noise and fast load current transitions. The delay time is approximately one clock cycle (varies between 0.5 and 1.5 clock) of the internal oscillator, which is programmed by the timer capacitor. The typical charge waveforms in [Figure 16](#) show the complete cycle operation.

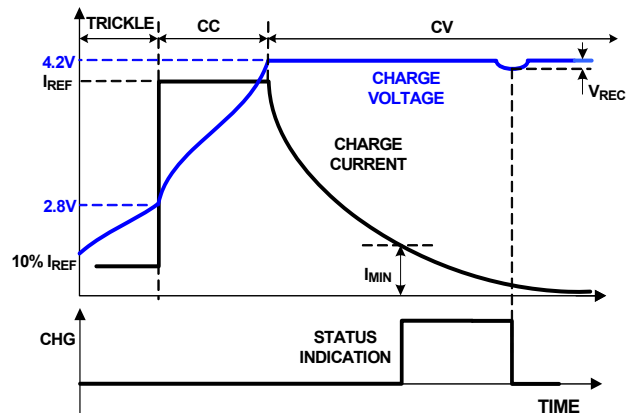

FIGURE 16. TYPICAL CHARGE CYCLE WITH TIMEOUT

Temperature Monitoring and Thermal Foldback

In the event the die temperature reaches the thermal foldback threshold (+110°C typical), the charge current is reduced accordingly to prevent further temperature rise. In the ISL9205 and ISL9205D versions, there is an external temperature monitoring function. A Negative Temperature Coefficient (NTC) thermistor can be connected between the TEMP pin and GND to monitor the battery temperature or ambient temperature. The hysteresis comparators internal to the ISL9205 family provide a valid temperature window centered at the voltage of the TEMP pin, which is programmed by the NTC and the pull-up resistor connected to the pin. When the measured temperature is outside this window, the charger is paused (both the charger and the timer are stopped) and a fault indication is issued. If the thermistor is attached to the battery, the TEMP function can be used to discover a battery removal condition when the TEMP pin voltage is much higher than the reference threshold.

POR

The Power-On Reset (POR) function monitors the supply voltage. The POR has a rising edge threshold of 3.6V typical and 2.5V typical for the falling edge. The charger is expected to operate when the input voltage is above the POR threshold. After POR, the charger continues to operate for supply voltage down to 2.5V, typical. It is also required that the supply voltage be higher than the VBAT pin voltage by a typical 80mV for the charger to function.

Oscillator, TIMEOUT, and Charge Cycle

The ISL9205 family incorporates an oscillation circuit using an external timing capacitor connected to the TIME pin. The oscillator sets the limit for the maximum charge time during the Trickle mode and the fast mode (CC and CV). The maximum charge time (TIMEOUT) for the fast mode is set by:

$$\text{TIMEOUT} = 2^{22} t_{\text{OSC}}$$

where the t_{OSC} is the oscillator period. The minimum programmable t_{OSC} is 20 μs ($C_{\text{TIME}} = 100\text{pF}$). The time limit for the trickle charge is 1/8 of the fast mode time limit. In the ISL9205 family, the timeout function can be disabled by pulling the TOEN pin to logic LOW. When TIMEOUT is disabled, the charger is never turned off in Constant Current and Constant Voltage modes. For the ISL9205B and the ISL9105D, the timeout function is always enforced. For the ISL9105A, there is not timeout function.

A charge cycle is the time interval between the time when the charger is enabled to the moment it is disabled. If the battery voltage is lower than the trickle charge threshold at the time the charger is enabled, the charger enters the Trickle mode and the timer is reset and its limit is set to 1/8 of TIMEOUT. If the timeout function is enabled, the charger stops and indicates a TIMEOUT fault if the charge time is longer than the limit. If the Trickle mode completes successfully before the time limit, the charger moves to CC mode and the timer is reset and the time limit is set to TIMEOUT. The charger needs to reach the EOC conditions before the TIMEOUT interval elapses, otherwise, a TIMEOUT fault is issued. The charger indicates the EOC with the STATUS pin but does not terminate charging.

Disabling TIMEOUT with TOEN

In the ISL9205 family, the timeout function in fast charge state (CC/CV) can be disabled by pulling the TOEN pin to logic LOW. The timeout function for the Trickle Charge mode can not be disabled. Note that in the ISL9205A, there is no timeout function for both the trickle and the CC/CV intervals, whereas in the ISL9205 with TOEN set pulled to LOW, there is no timeout for the CC/CV interval but the timeout function for the trickle interval is still enforced.

Indications

The ISL9205 family has two open-drain status indication pins. These two pins are $\overline{\text{FAULT}}$ and $\overline{\text{STATUS}}$. These pins require an external pull-up resistor to function properly. The V2P8 pin can be used to indicate the presence of an AC adapter. When an adapter pulses in, V2P8 is at 2.8V (logic Hi), otherwise V2P8 pin is at zero voltage (logic Lo).

Charger Disable

The EN pin allows the user to disable the charger. When the charger is disabled, all internal circuits are shut down and the quiescent current at the input pin is less than a typical value of 150 μA .

Remote Battery Voltage Sensing

In the ISL9205, ISL9205A, ISL9205B, and ISL9205C versions, a Kelvin sense pin is provided for battery terminal voltage monitoring. Thus, the IR drop due to the connection leads and PCB traces can be eliminated, resulting in a more accurate battery voltage monitoring, especially when the battery is located at a

significant distance away from the ISL9205. If remote sensing is not needed, the VSEN pin can be connected to VBAT at the IC.

Applications Information

PCB Layout Guidance

The ISL9205 family uses thermally-enhanced QFN/DFN packages that have an exposed thermal pad at the bottom side of the package. The layout should connect as much as possible to copper on the exposed pad. Typically, the component layer is more effective in dissipating heat. The thermal impedance can be further reduced by using other layers of copper connecting to the exposed pad through a thermal via array. A minimum of four such thermal vias are recommended. Each thermal via is recommended to have 0.3mm diameter and 0.7mm distance from other thermal vias.

Stability Consideration

The ISL9205 should behave like a current and thermal limited linear regulator. The charger operation is stable with an output ceramic decoupling capacitor in the range of 1 μF to 200 μF , with or without a battery connected.

Input Bypass Capacitor

Due to the inductance of the power leads of the wall adapter or USB source, the input capacitor type must be properly selected to prevent high voltage transients during a hot-plug event. A tantalum capacitor is a good choice for its high ESR, providing damping to the voltage transients. Multi-layer ceramic capacitors, however, have a very low ESR and hence, when chosen as input capacitor, a 1 Ω series resistor must be used to provide adequate damping, as shown in the ["Typical Applications" on page 5](#).

State Machine Diagram

The state machine diagram is shown in [Figure 17 on page 13](#). The diagram starts with the Power-Off state. When the input voltage rises above the POR threshold, the charger resets itself. Then, if the charger is disabled, the charger stays in the Charger Disabled state. If the charger is enabled, the trickle charge starts. At any time, when entering the trickle charge state, the internal TIMEOUT timer is reset. Two paths to exit the trickle charge are:

- When the battery voltage rises above the preconditioning charge threshold within the 1/8 TIMEOUT interval
- When the 1/8 TIMEOUT interval has been elapsed before reaching the preconditioning charge voltage threshold

When a TIMEOUT fault occurs, the charger enters the TIMEOUT fault state. Two ways to exit the TIMEOUT fault state are:

- Toggling the EN input
- Re-cycling the input power

If the charger finishes the trickle charge before the 1/8 TIMEOUT limit, it moves to the fast charge state. When entering the fast charge state, the TIMEOUT timer is reset as well. If the charger hits EOC conditions before the TIMEOUT, the charger enters Charge Compete state. The charger stays on, but the STATUS indicates EOC condition. When VBAT drops below the recharge threshold, the STATUS pin turns to logic low to indicate charging again.

Revision History The revision history provided is for informational purposes only and is believed to be accurate, but not warranted. Visit our website to make sure you have the latest revision.

DATE	REVISION	CHANGE
Dec 20, 2018	FN9252.4	Updated Ordering Information table. Added tape and reel column, parts, added evaluation boards, and updated Note 1. Combined Pin Description tables into one table. Updated typo in Charger Disable section, page 13. Changed "150mA" to "150µA". Removed About Intersil section. Updated disclaimer.
Sep 30, 2016	FN9252.3	Changed ISL9205 part number throughout to ISL9205, ISL9205A, ISL9205B, ISL9205C, ISL9205D. Updated entire datasheet applying Intersil's new standards. Added Revision History and About Intersil sections. Edited on page 4 from "Typically a 10µF Tantalum capacitor is needed for stability when there is no battery attached" to "Typically a ceramic capacitor of minimum 1µF is needed for stability when there is no battery attached".

Package Outline Drawings

L16.3x3B

16 LEAD QUAD FLAT NO-LEAD PLASTIC PACKAGE

Rev 1, 4/07

For the most recent package outline drawing, see [L16.3x3B](#).

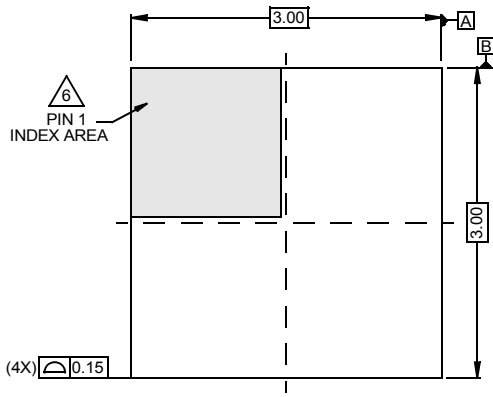

TOP VIEW

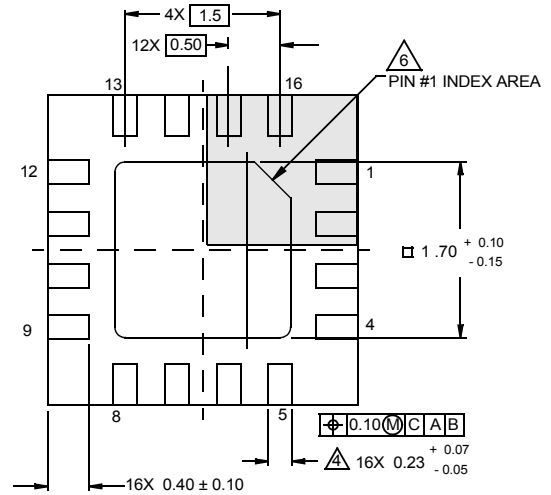

BOTTOM VIEW

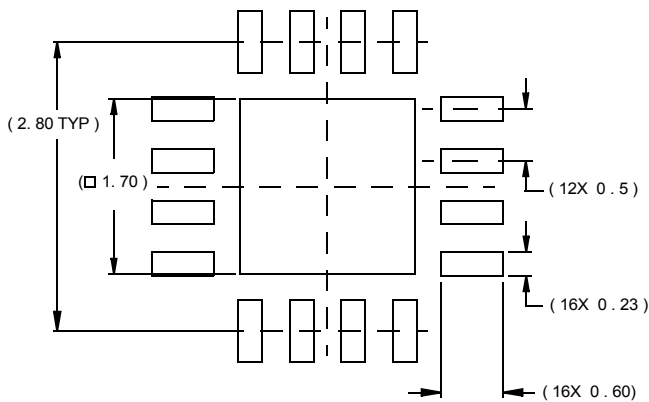

TYPICAL RECOMMENDED LAND PATTERN

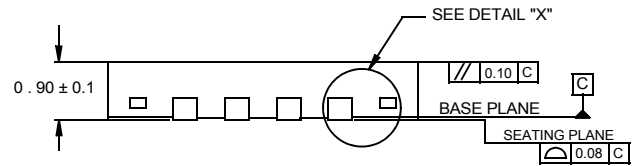

SIDE VIEW

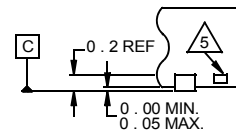

DETAIL "X"

NOTES:

1. Dimensions are in millimeters.
Dimensions in () for Reference Only.
2. Dimensioning and tolerancing conform to AMSE Y14.5m-1994.
3. Unless otherwise specified, tolerance : Decimal ± 0.05
4. Dimension b applies to the metallized terminal and is measured between 0.15mm and 0.30mm from the terminal tip.
5. Tiebar shown (if present) is a non-functional feature.
6. The configuration of the pin #1 identifier is optional, but must be located within the zone indicated. The pin #1 identifier may be either a mold or mark feature.

Package Outline Drawing

L10.3x3

10 LEAD DUAL FLAT PACKAGE (DFN)

Rev 11, 3/15

For the most recent package outline drawing, see [L10.3x3](#).

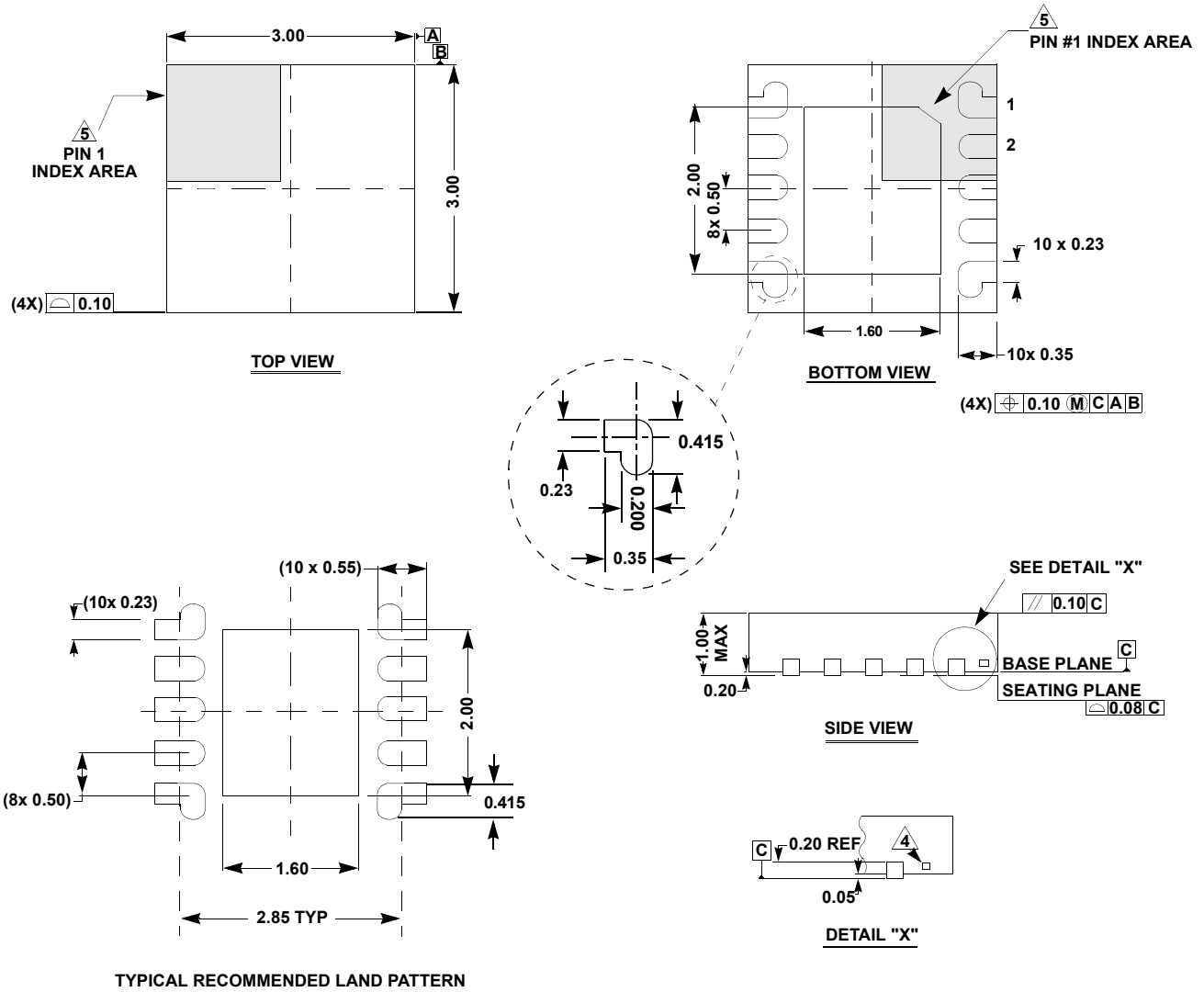

NOTES:

1. Dimensions are in millimeters.
Dimensions in () for Reference Only.
2. Dimensioning and tolerancing conform to ASME Y14.5m-1994.
3. Unless otherwise specified, tolerance : Decimal ± 0.05
4. Tiebar shown (if present) is a non-functional feature and may be located on any of the 4 sides (or ends).
5. The configuration of the pin #1 identifier is optional, but must be located within the zone indicated. The pin #1 identifier may be either a mold or mark feature.

Notice

1. Descriptions of circuits, software and other related information in this document are provided only to illustrate the operation of semiconductor products and application examples. You are fully responsible for the incorporation or any other use of the circuits, software, and information in the design of your product or system. Renesas Electronics disclaims any and all liability for any losses and damages incurred by you or third parties arising from the use of these circuits, software, or information.
 2. Renesas Electronics hereby expressly disclaims any warranties against and liability for infringement or any other claims involving patents, copyrights, or other intellectual property rights of third parties, by or arising from the use of Renesas Electronics products or technical information described in this document, including but not limited to, the product data, drawings, charts, programs, algorithms, and application examples.
 3. No license, express, implied or otherwise, is granted hereby under any patents, copyrights or other intellectual property rights of Renesas Electronics or others.
 4. You shall not alter, modify, copy, or reverse engineer any Renesas Electronics product, whether in whole or in part. Renesas Electronics disclaims any and all liability for any losses or damages incurred by you or third parties arising from such alteration, modification, copying or reverse engineering.
 5. Renesas Electronics products are classified according to the following two quality grades: "Standard" and "High Quality". The intended applications for each Renesas Electronics product depends on the product's quality grade, as indicated below.
"Standard": Computers; office equipment; communications equipment; test and measurement equipment; audio and visual equipment; home electronic appliances; machine tools; personal electronic equipment; industrial robots; etc.
"High Quality": Transportation equipment (automobiles, trains, ships, etc.); traffic control (traffic lights); large-scale communication equipment; key financial terminal systems; safety control equipment; etc.
Unless expressly designated as a high reliability product or a product for harsh environments in a Renesas Electronics data sheet or other Renesas Electronics document, Renesas Electronics products are not intended or authorized for use in products or systems that may pose a direct threat to human life or bodily injury (artificial life support devices or systems; surgical implantations; etc.), or may cause serious property damage (space system; undersea repeaters; nuclear power control systems; aircraft control systems; key plant systems; military equipment; etc.). Renesas Electronics disclaims any and all liability for any damages or losses incurred by you or any third parties arising from the use of any Renesas Electronics product that is inconsistent with any Renesas Electronics data sheet, user's manual or other Renesas Electronics document.
 6. When using Renesas Electronics products, refer to the latest product information (data sheets, user's manuals, application notes, "General Notes for Handling and Using Semiconductor Devices" in the reliability handbook, etc.), and ensure that usage conditions are within the ranges specified by Renesas Electronics with respect to maximum ratings, operating power supply voltage range, heat dissipation characteristics, installation, etc. Renesas Electronics disclaims any and all liability for any malfunctions, failure or accident arising out of the use of Renesas Electronics products outside of such specified ranges.
 7. Although Renesas Electronics endeavors to improve the quality and reliability of Renesas Electronics products, semiconductor products have specific characteristics, such as the occurrence of failure at a certain rate and malfunctions under certain use conditions. Unless designated as a high reliability product or a product for harsh environments in a Renesas Electronics data sheet or other Renesas Electronics document, Renesas Electronics products are not subject to radiation resistance design. You are responsible for implementing safety measures to guard against the possibility of bodily injury, injury or damage caused by fire, and/or danger to the public in the event of a failure or malfunction of Renesas Electronics products, such as safety design for hardware and software, including but not limited to redundancy, fire control and malfunction prevention, appropriate treatment for aging degradation or any other appropriate measures. Because the evaluation of microcomputer software alone is very difficult and impractical, you are responsible for evaluating the safety of the final products or systems manufactured by you.
 8. Please contact a Renesas Electronics sales office for details as to environmental matters such as the environmental compatibility of each Renesas Electronics product. You are responsible for carefully and sufficiently investigating applicable laws and regulations that regulate the inclusion or use of controlled substances, including without limitation, the EU RoHS Directive, and using Renesas Electronics products in compliance with all these applicable laws and regulations. Renesas Electronics disclaims any and all liability for damages or losses occurring as a result of your noncompliance with applicable laws and regulations.
 9. Renesas Electronics products and technologies shall not be used for or incorporated into any products or systems whose manufacture, use, or sale is prohibited under any applicable domestic or foreign laws or regulations. You shall comply with any applicable export control laws and regulations promulgated and administered by the governments of any countries asserting jurisdiction over the parties or transactions.
 10. It is the responsibility of the buyer or distributor of Renesas Electronics products, or any other party who distributes, disposes of, or otherwise sells or transfers the product to a third party, to notify such third party in advance of the contents and conditions set forth in this document.
 11. This document shall not be reprinted, reproduced or duplicated in any form, in whole or in part, without prior written consent of Renesas Electronics.
 12. Please contact a Renesas Electronics sales office if you have any questions regarding the information contained in this document or Renesas Electronics products.
- (Note 1) "Renesas Electronics" as used in this document means Renesas Electronics Corporation and also includes its directly or indirectly controlled subsidiaries.
(Note 2) "Renesas Electronics product(s)" means any product developed or manufactured by or for Renesas Electronics.

(Rev.4.0-1 November 2017)



SALES OFFICES

Renesas Electronics Corporation

<http://www.renesas.com>

Refer to "<http://www.renesas.com>" for the latest and detailed information.

Renesas Electronics Corporation

TOYOSU FORESIA, 3-2-24 Toyosu, Koto-ku, Tokyo 135-0061, Japan

Renesas Electronics America Inc.

1001 Murphy Ranch Road, Milpitas, CA 95035, U.S.A.
Tel: +1-408-432-8888, Fax: +1-408-434-5351

Renesas Electronics Canada Limited

9251 Yonge Street, Suite 8309 Richmond Hill, Ontario Canada L4C 9T3
Tel: +1-905-237-2004

Renesas Electronics Europe Limited

Dukes Meadow, Millboard Road, Bourne End, Buckinghamshire, SL8 5FH, U.K
Tel: +44-1628-651-700

Renesas Electronics Europe GmbH

Arcadiastrasse 10, 40472 Düsseldorf, Germany
Tel: +49-211-6503-0, Fax: +49-211-6503-1327

Renesas Electronics (China) Co., Ltd.

Room 1709 Quantum Plaza, No.27 ZhichunLu, Haidian District, Beijing, 100191 P. R. China
Tel: +86-10-8235-1155, Fax: +86-10-8235-7679

Renesas Electronics (Shanghai) Co., Ltd.

Unit 301, Tower A, Central Towers, 555 Langao Road, Putuo District, Shanghai, 200333 P. R. China
Tel: +86-21-2226-0888, Fax: +86-21-2226-0999

Renesas Electronics Hong Kong Limited

Unit 1601-1611, 16/F., Tower 2, Grand Century Place, 193 Prince Edward Road West, Mongkok, Kowloon, Hong Kong
Tel: +852-2265-6688, Fax: +852 2886-9022

Renesas Electronics Taiwan Co., Ltd.

13F, No. 363, Fu Shing North Road, Taipei 10543, Taiwan
Tel: +886-2-8175-9600, Fax: +886 2-8175-9670

Renesas Electronics Singapore Pte. Ltd.

80 Bendemeer Road, Unit #06-02 Hyflux Innovation Centre, Singapore 339949
Tel: +65-6213-0200, Fax: +65-6213-0300

Renesas Electronics Malaysia Sdn.Bhd.

Unit 1207, Block B, Menara Amcorp, Amcorp Trade Centre, No. 18, Jln Persiaran Barat, 46050 Petaling Jaya, Selangor Darul Ehsan, Malaysia
Tel: +60-3-7955-9390, Fax: +60-3-7955-9510

Renesas Electronics India Pvt. Ltd.

No.777C, 100 Feet Road, HAL 2nd Stage, Indiranagar, Bangalore 560 038, India
Tel: +91-80-67208700, Fax: +91-80-67208777

Renesas Electronics Korea Co., Ltd.

17F, KAMCO Yangjae Tower, 262, Gangnam-daero, Gangnam-gu, Seoul, 06265 Korea
Tel: +82-2-558-3737, Fax: +82-2-558-5338