

Description: ISM868/915MHz, 2.4GHz Ant

Series: PCB Embedded

PART NUMBER: W3331



Features:

- Small clearance needed (about 4mm)
- Test PCB size 118.5\*102mm
- High efficiency
- Small compact form factor
- Low profile
- Multi-band (ISM and 2.4 GHz)
- Board Mountable
- 2 connection points
- Lead free materials
- RoHS Compliant Product

Applications:

- Data transmission for IoT applications
- High speed data terminals
- Routers using ISM frequencies
- ISM and WiFi dual applications
- Hot Spots
- Radio modules
- WiFi / BLE / Zigbee

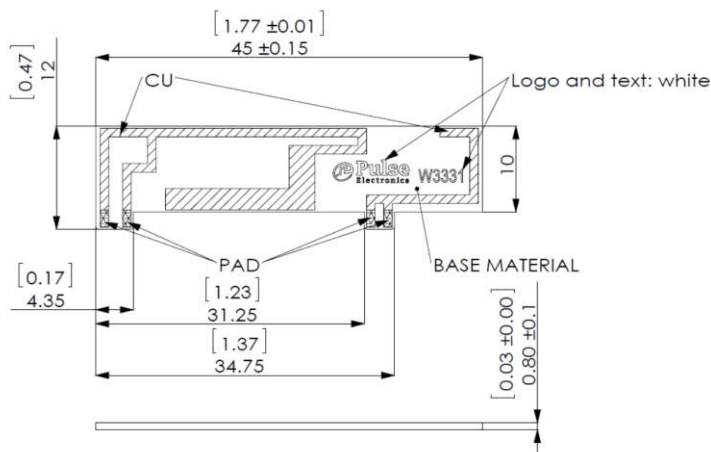

All dimensions are in mm / inches

Issue: 1612

In the effort to improve our products, we reserve the right to make changes judged to be necessary.

CONFIDENTIAL AND PROPRIETARY INFORMATION

This document contains confidential and proprietary information of Pulse Electronics, Inc. (Pulse) and is protected by copyright, trade secret and other state and federal laws. Its receipt or possession does not convey any rights to reproduce, disclose its contents, or to manufacture, use or sell anything it may describe. Reproduction, disclosure or use without specific written authorization of Pulse is strictly forbidden.

For more information:

Pulse Worldwide Headquarters  
12220 World Trade Drive  
San Diego, CA 92128  
USA  
Tel: 1-858-674-8100

Pulse/Larsen Antennas  
3611 NE 112<sup>th</sup> Ave  
Vancouver, WA 98682  
USA  
Tel: 1-360-944-7551

Europe Headquarters  
Pulse GmbH & Do, KG  
Zeppelinstrasse 15  
Herrenberg, Germany  
Tel: 49 7032 7806 0

Pulse (Suzhou) Wireless Products Co, Inc.  
99 Huo Ju Road(#29 Bldg,4<sup>th</sup> Phase  
Suzhou New District  
Jiangsu Province, Suzhou 215009 PR China  
Tel: 86 512 6807 9998



Description: ISM868/915MHz, 2.4GHz Ant

Series: PCB Embedded

PART NUMBER: W3331

**ELECTRICAL SPECIFICATIONS**

Frequency port1	863-928MHz
Frequency port2	2400-2500MHz
Nominal Impedance	50Ω
Return Loss	-6dB max@ISM868/915MHz -12dB max@ISM2.4GHz
Isolation between port1 & port2	-15dB
Average efficiency	65% @ISM868/915MHz 75%@ISM2.4GHz
Gain	2 +/- 1 dBi@ISM868/915MHz 3.5 +/- 1 dBi@ISM2.4GHz
Radiation Pattern	Omni
Polarization:	linear
Power withstanding	3W

Issue: 1612

In the effort to improve our products, we reserve the right to make changes judged to be necessary.

CONFIDENTIAL AND PROPRIETARY INFORMATION

This document contains confidential and proprietary information of Pulse Electronics, Inc. (Pulse) and is protected by copyright, trade secret and other state and federal laws. Its receipt or possession does not convey any rights to reproduce, disclose its contents, or to manufacture, use or sell anything it may describe. Reproduction, disclosure or use without specific written authorization of Pulse is strictly forbidden.

Description: ISM868/915MHz, 2.4GHz Ant

Series: PCB Embedded

PART NUMBER: **W3331****MECHANICAL SPECIFICATIONS**

PCB material	FR4
Color	Black
Weight	0.75g
Overall Length	1.77 INCHES
Overall width	0.47 INCHES

Issue: 1612

In the effort to improve our products, we reserve the right to make changes judged to be necessary.

CONFIDENTIAL AND PROPRIETARY INFORMATION

This document contains confidential and proprietary information of Pulse Electronics, Inc. (Pulse) and is protected by copyright, trade secret and other state and federal laws. Its receipt or possession does not convey any rights to reproduce, disclose its contents, or to manufacture, use or sell anything it may describe. Reproduction, disclosure or use without specific written authorization of Pulse is strictly forbidden.

Description: ISM868/915MHz, 2.4GHz Ant

Series: PCB Embedded

PART NUMBER: W3331

MECHANICAL DRAWING

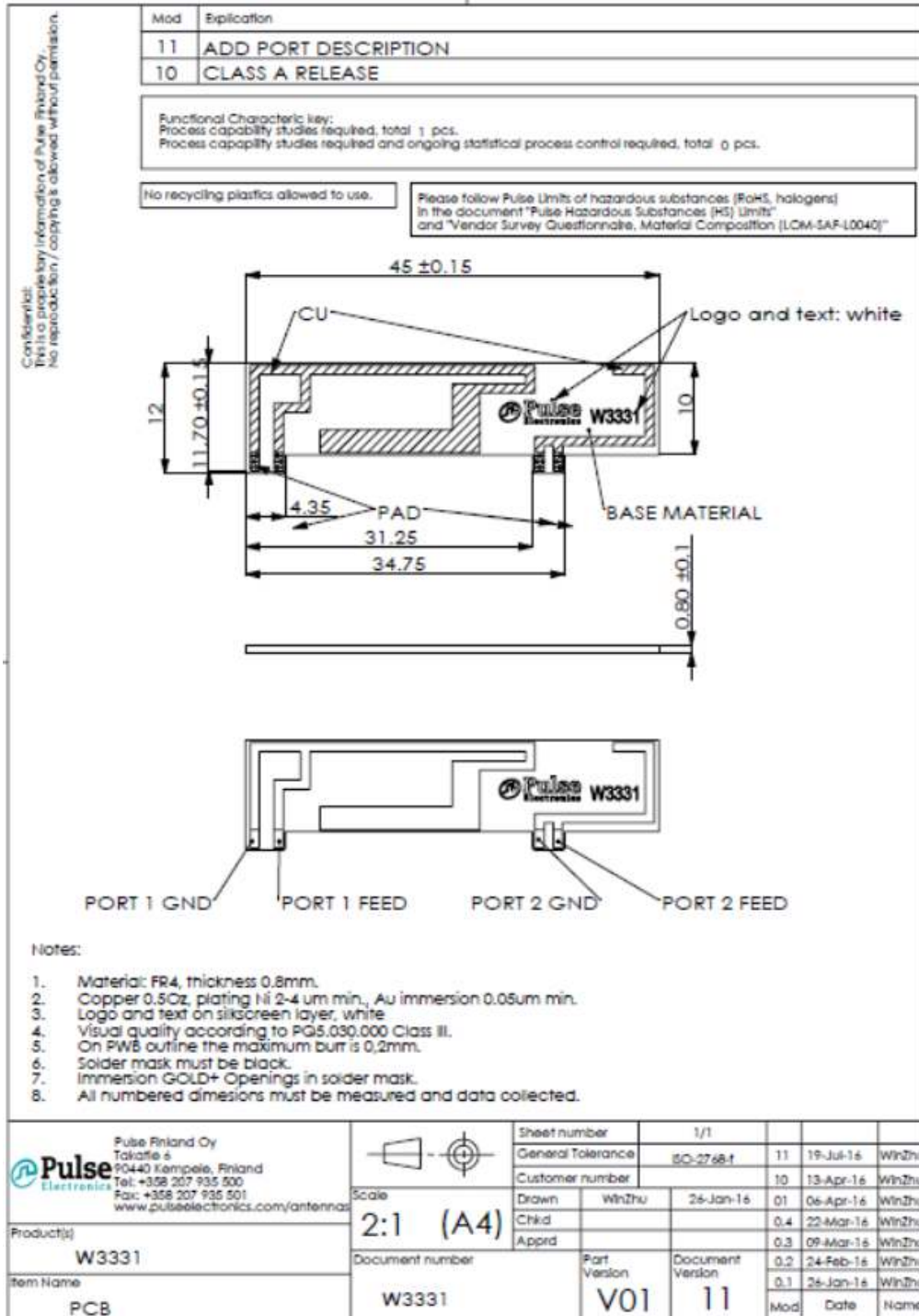

Issue: 1612

In the effort to improve our products, we reserve the right to make changes judged to be necessary.

CONFIDENTIAL AND PROPRIETARY INFORMATION

This document contains confidential and proprietary information of Pulse Electronics, Inc. (Pulse) and is protected by copyright, trade secret and other state and federal laws. Its receipt or possession does not convey any rights to reproduce, disclose its contents, or to manufacture, use or sell anything it may describe. Reproduction, disclosure or use without specific written authorization of Pulse is strictly forbidden.

Description: ISM868/915MHz, 2.4GHz Ant

Series: PCB Embedded

PART NUMBER: W3331

OTHER SPECIFICATIONS

Recommended PCB layout(Unit:mm)

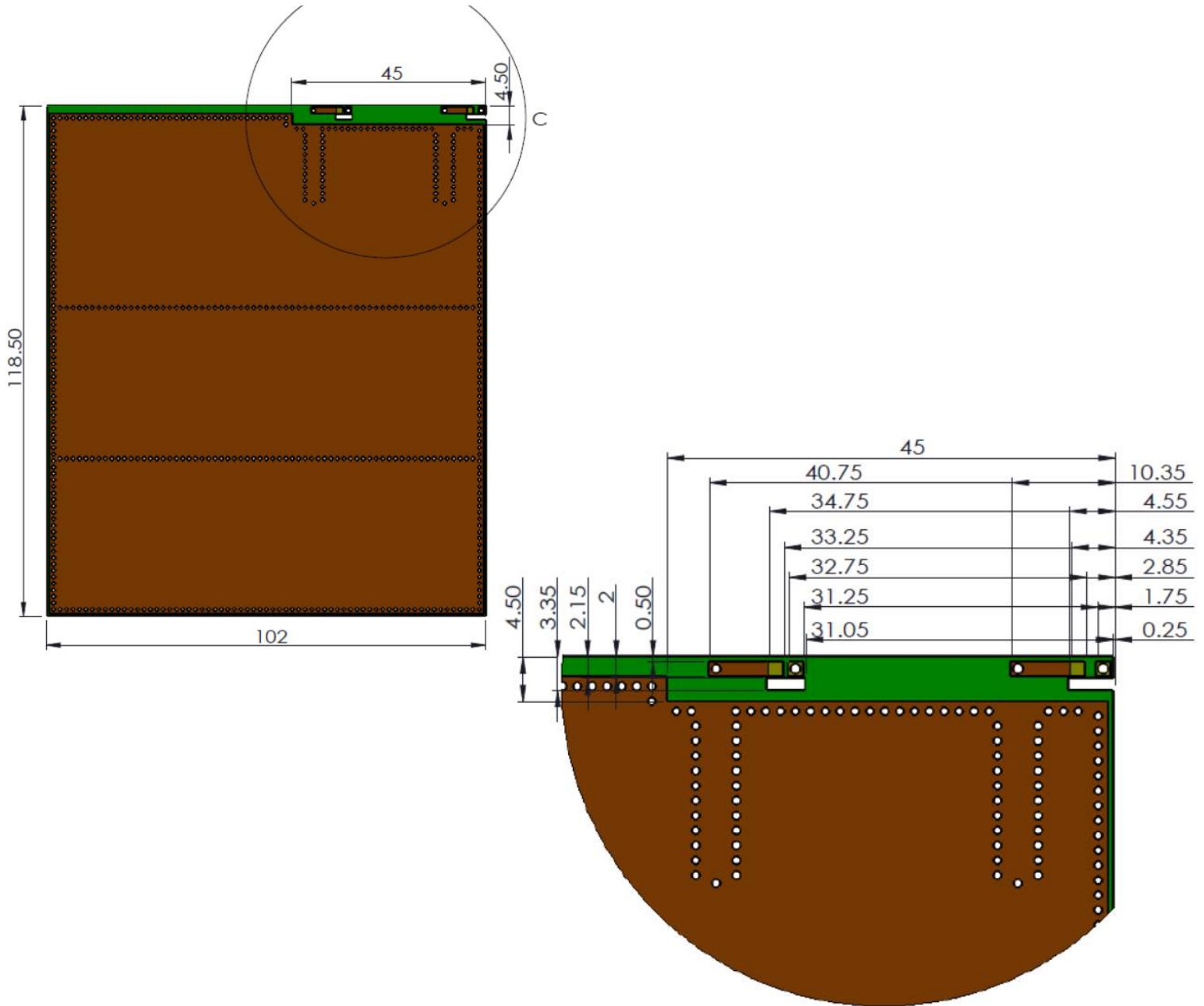

Issue: 1612

In the effort to improve our products, we reserve the right to make changes judged to be necessary.

CONFIDENTIAL AND PROPRIETARY INFORMATION

This document contains confidential and proprietary information of Pulse Electronics, Inc. (Pulse) and is protected by copyright, trade secret and other state and federal laws. Its receipt or possession does not convey any rights to reproduce, disclose its contents, or to manufacture, use or sell anything it may describe. Reproduction, disclosure or use without specific written authorization of Pulse is strictly forbidden.



Description: ISM868/915MHz, 2.4GHz Ant

Series: PCB Embedded

PART NUMBER: W3331

CHARTS

ISM868/915MHz band Return Loss

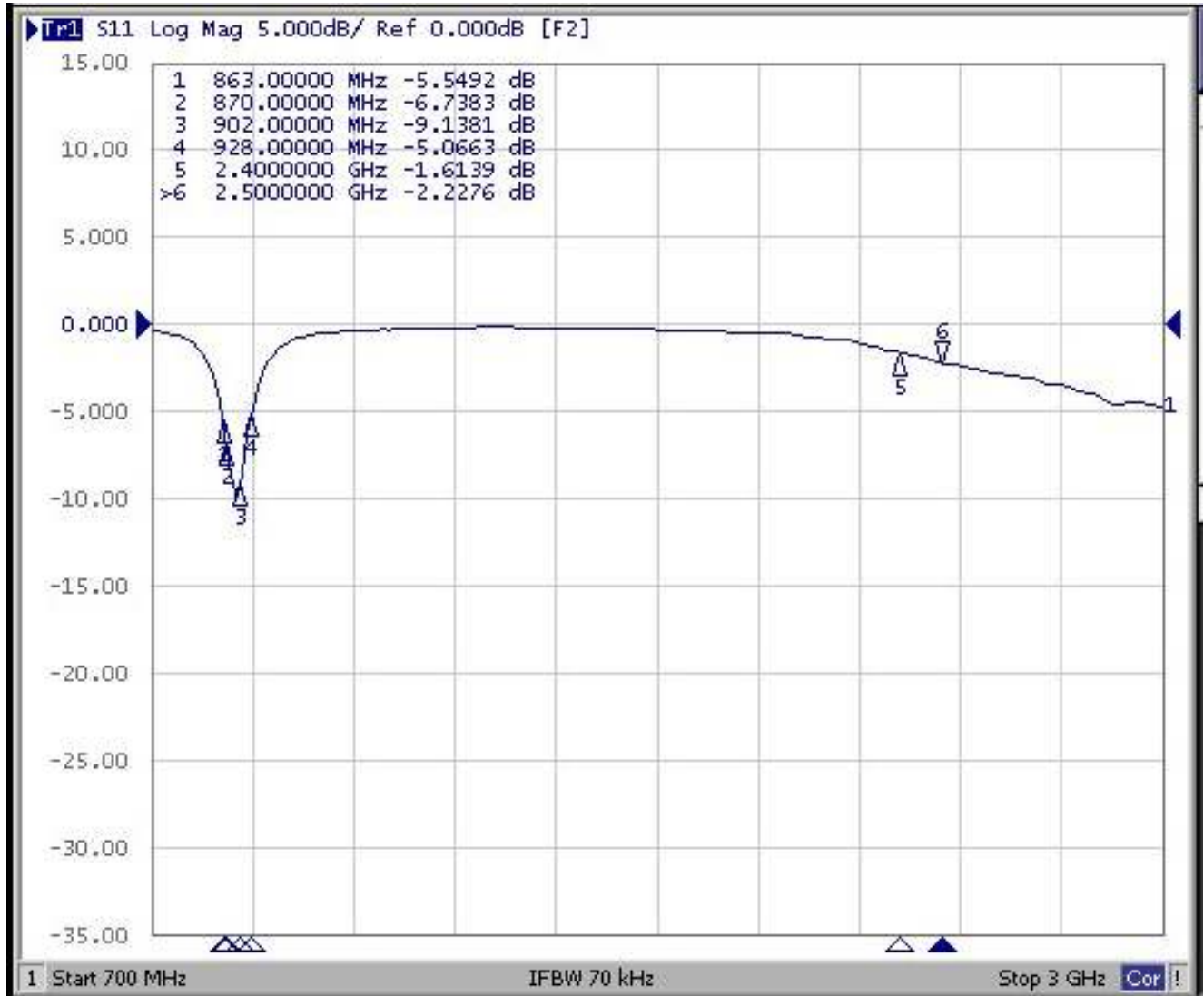

Issue: 1612

In the effort to improve our products, we reserve the right to make changes judged to be necessary.

CONFIDENTIAL AND PROPRIETARY INFORMATION

This document contains confidential and proprietary information of Pulse Electronics, Inc. (Pulse) and is protected by copyright, trade secret and other state and federal laws. Its receipt or possession does not convey any rights to reproduce, disclose its contents, or to manufacture, use or sell anything it may describe. Reproduction, disclosure or use without specific written authorization of Pulse is strictly forbidden.

Description: ISM868/915MHz, 2.4GHz Ant

Series: PCB Embedded

PART NUMBER: W3331

CHARTS

ISM2.4GHz Return Loss

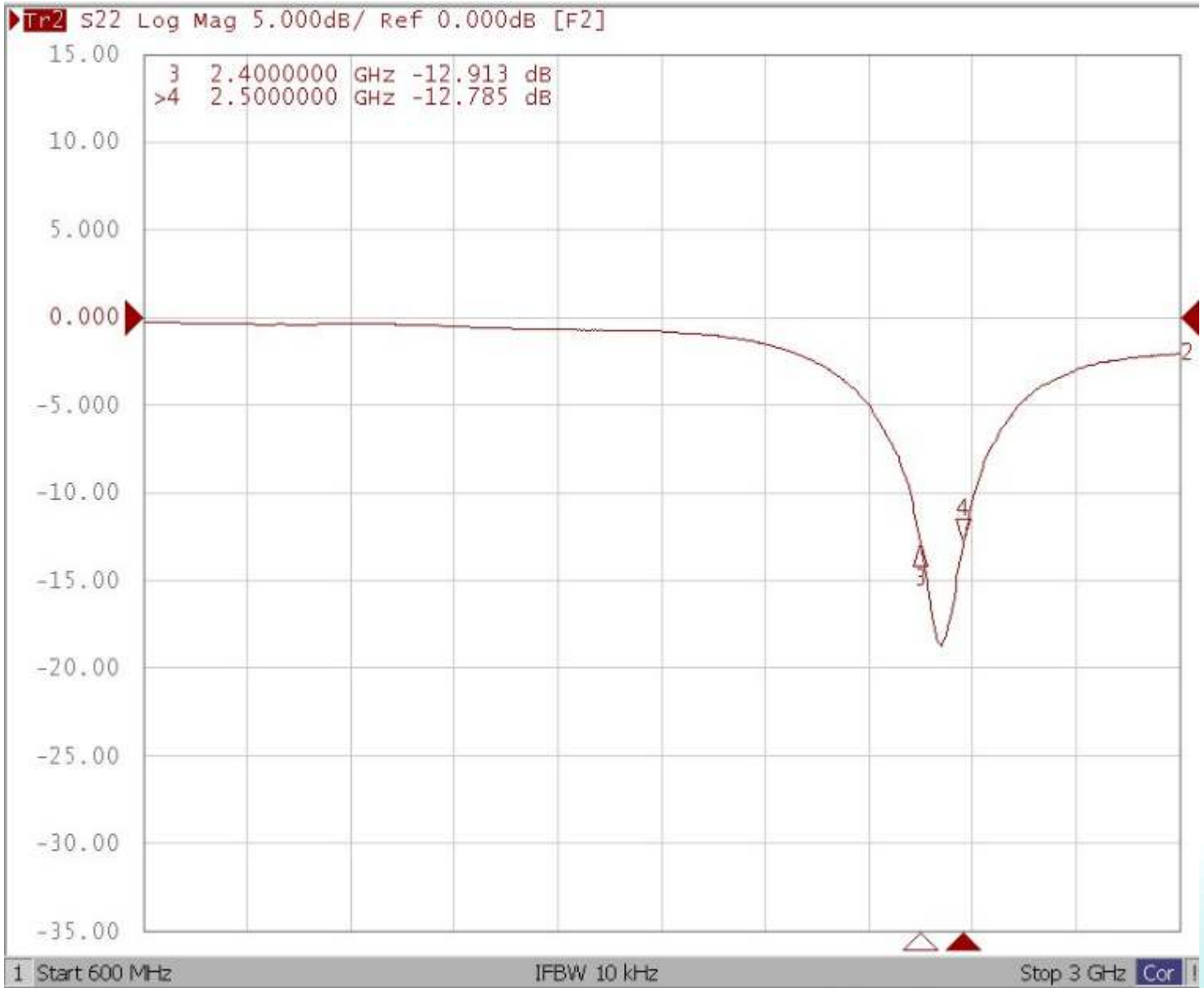

Issue: 1612

In the effort to improve our products, we reserve the right to make changes judged to be necessary.

CONFIDENTIAL AND PROPRIETARY INFORMATION

This document contains confidential and proprietary information of Pulse Electronics, Inc. (Pulse) and is protected by copyright, trade secret and other state and federal laws. Its receipt or possession does not convey any rights to reproduce, disclose its contents, or to manufacture, use or sell anything it may describe. Reproduction, disclosure or use without specific written authorization of Pulse is strictly forbidden.



Description: ISM868/915MHz, 2.4GHz Ant

Series: PCB Embedded

PART NUMBER: W3331

CHARTS

Isolation

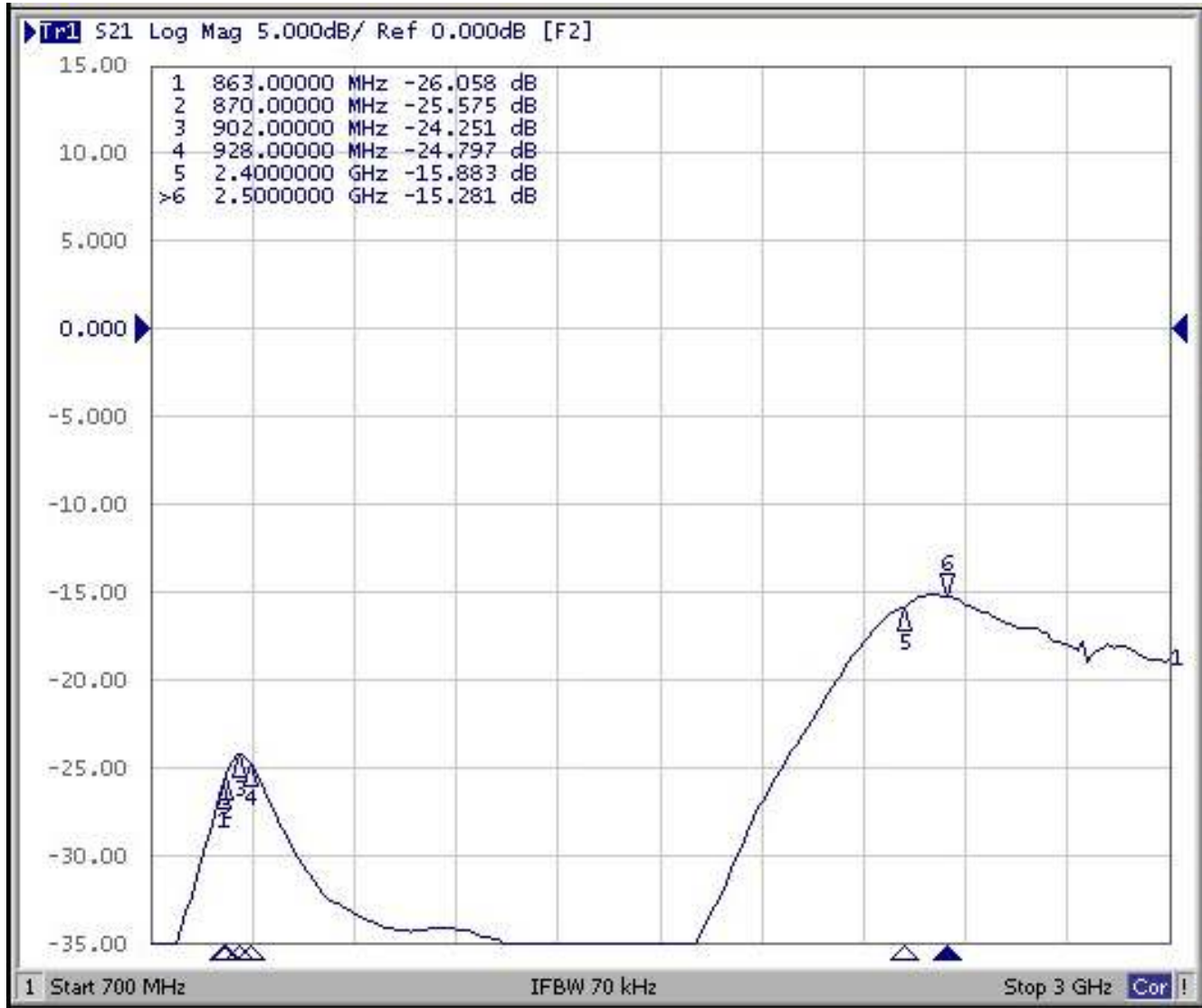

Issue: 1612

In the effort to improve our products, we reserve the right to make changes judged to be necessary.

CONFIDENTIAL AND PROPRIETARY INFORMATION

This document contains confidential and proprietary information of Pulse Electronics, Inc. (Pulse) and is protected by copyright, trade secret and other state and federal laws. Its receipt or possession does not convey any rights to reproduce, disclose its contents, or to manufacture, use or sell anything it may describe. Reproduction, disclosure or use without specific written authorization of Pulse is strictly forbidden.

Description: ISM868/915MHz, 2.4GHz Ant

Series: PCB Embedded

PART NUMBER: W3331

CHARTS

Efficiency(%)

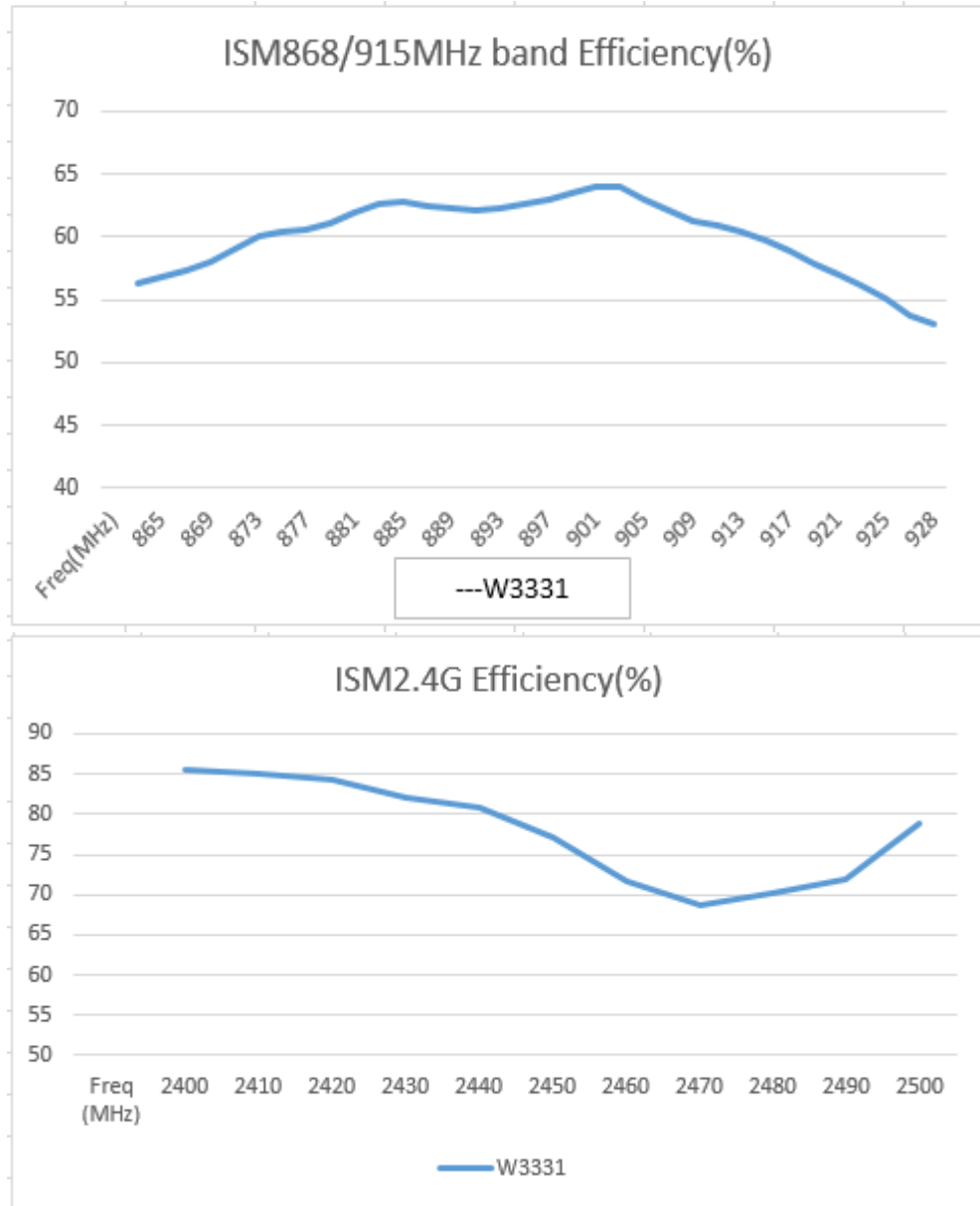

Issue: 1612

In the effort to improve our products, we reserve the right to make changes judged to be necessary.

CONFIDENTIAL AND PROPRIETARY INFORMATION

This document contains confidential and proprietary information of Pulse Electronics, Inc. (Pulse) and is protected by copyright, trade secret and other state and federal laws. Its receipt or possession does not convey any rights to reproduce, disclose its contents, or to manufacture, use or sell anything it may describe. Reproduction, disclosure or use without specific written authorization of Pulse is strictly forbidden.

Description: ISM868/915MHz, 2.4GHz Ant

Series: PCB Embedded

PART NUMBER: W3331

CHARTS

Peak Gain ( dBi)

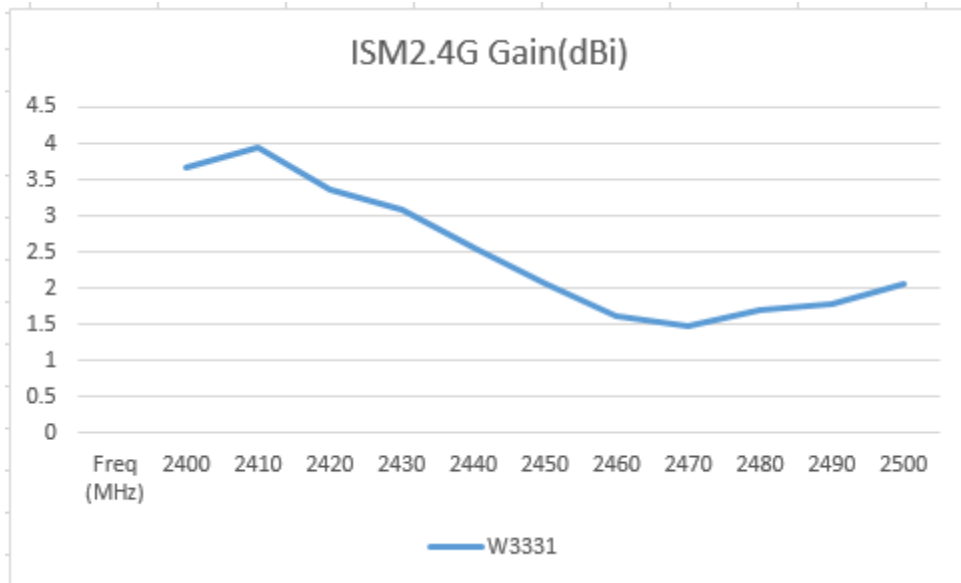
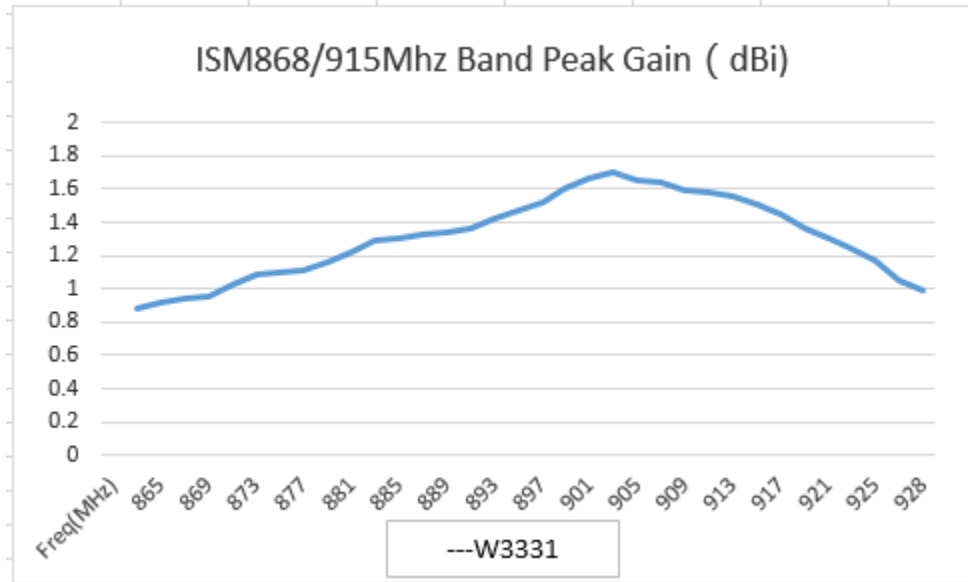

Issue: 1612

In the effort to improve our products, we reserve the right to make changes judged to be necessary.

CONFIDENTIAL AND PROPRIETARY INFORMATION

This document contains confidential and proprietary information of Pulse Electronics, Inc. (Pulse) and is protected by copyright, trade secret and other state and federal laws. Its receipt or possession does not convey any rights to reproduce, disclose its contents, or to manufacture, use or sell anything it may describe. Reproduction, disclosure or use without specific written authorization of Pulse is strictly forbidden.

Description: ISM868/915MHz, 2.4GHz Ant

Series: PCB Embedded

PART NUMBER: W3331

CHARTS

Typical free space radiation pattern  
ISM868/915MHz  
X-Y plane

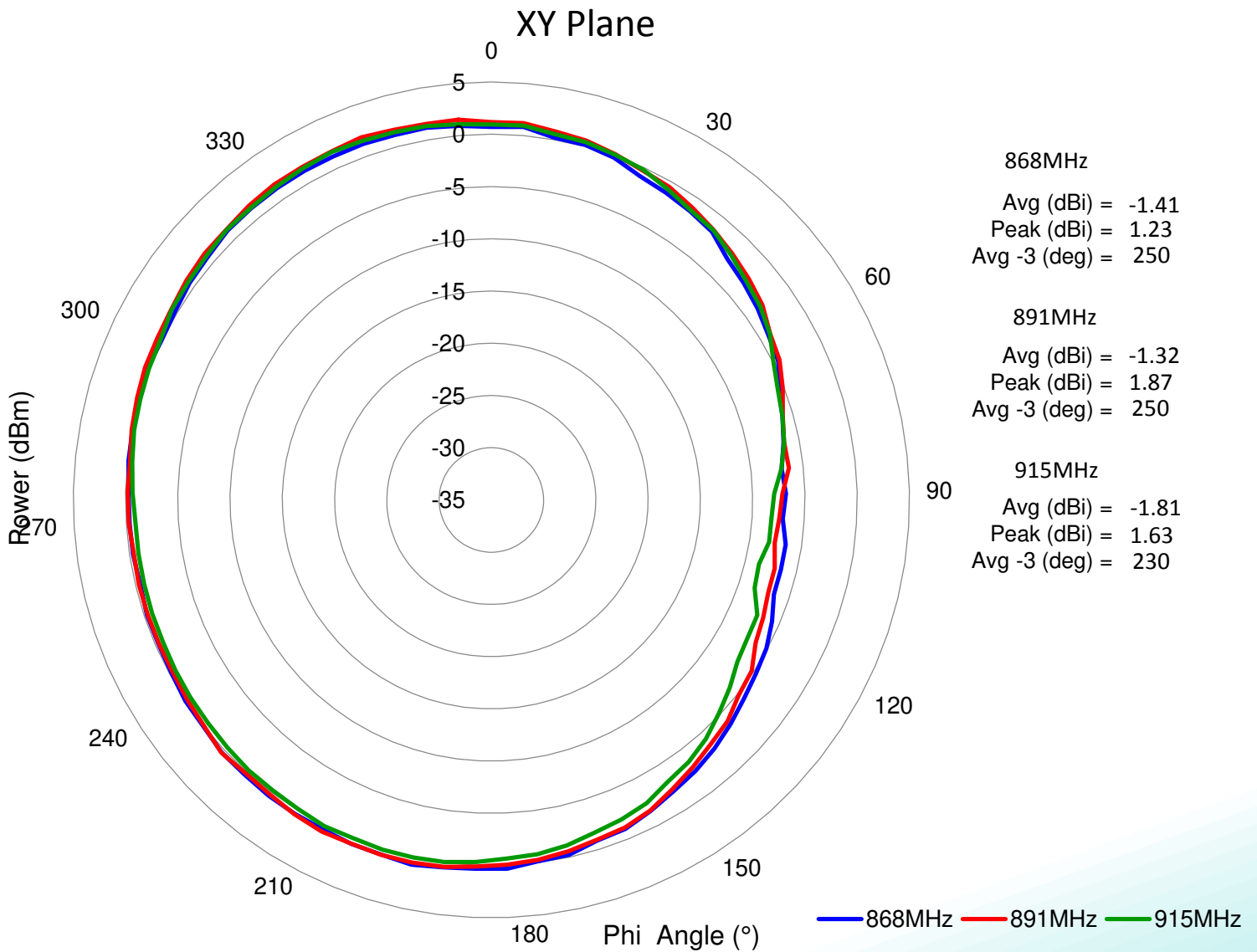

Issue: 1612

In the effort to improve our products, we reserve the right to make changes judged to be necessary.

CONFIDENTIAL AND PROPRIETARY INFORMATION

This document contains confidential and proprietary information of Pulse Electronics, Inc. (Pulse) and is protected by copyright, trade secret and other state and federal laws. Its receipt or possession does not convey any rights to reproduce, disclose its contents, or to manufacture, use or sell anything it may describe. Reproduction, disclosure or use without specific written authorization of Pulse is strictly forbidden.

Description: ISM868/915MHz, 2.4GHz Ant

Series: PCB Embedded

PART NUMBER: W3331

CHARTS

Typical free space radiation pattern  
ISM868/915MHz  
Z-X plane

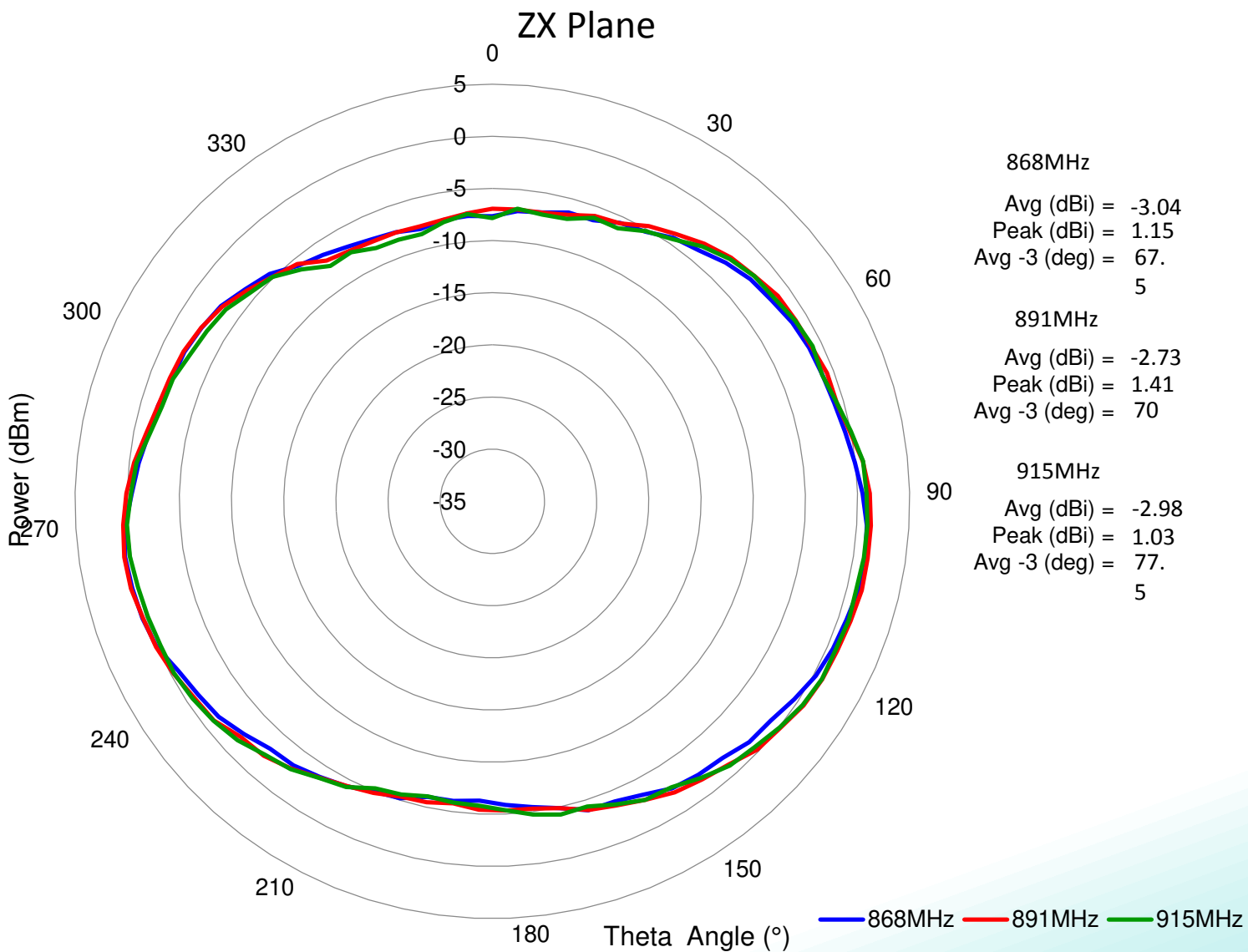

Issue: 1612

In the effort to improve our products, we reserve the right to make changes judged to be necessary.

CONFIDENTIAL AND PROPRIETARY INFORMATION

This document contains confidential and proprietary information of Pulse Electronics, Inc. (Pulse) and is protected by copyright, trade secret and other state and federal laws. Its receipt or possession does not convey any rights to reproduce, disclose its contents, or to manufacture, use or sell anything it may describe. Reproduction, disclosure or use without specific written authorization of Pulse is strictly forbidden.

Description: ISM868/915MHz, 2.4GHz Ant

Series: PCB Embedded

PART NUMBER: W3331

CHARTS

Typical free space radiation pattern  
ISM868/915MHz  
Z-Y plane

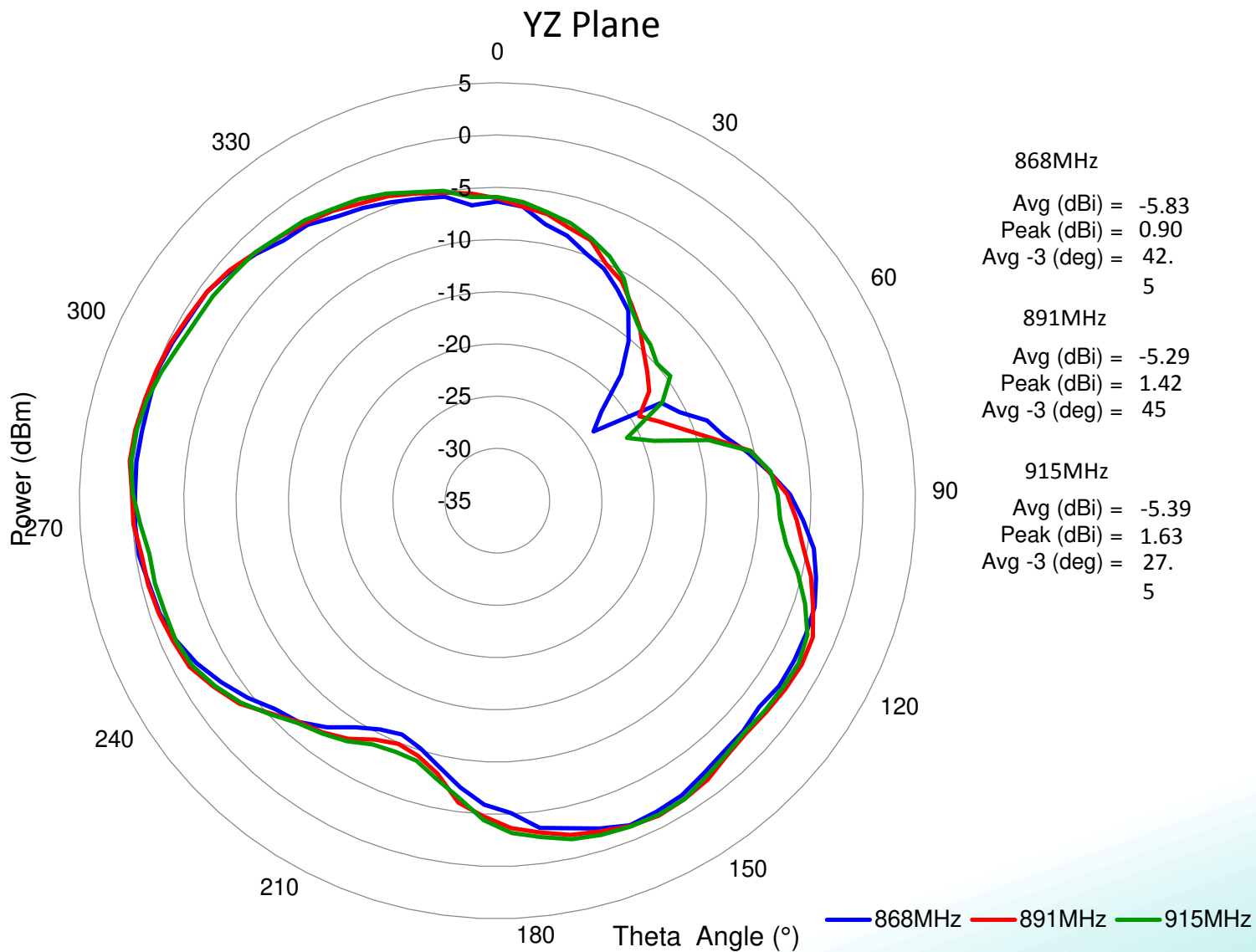

Issue: 1612

In the effort to improve our products, we reserve the right to make changes judged to be necessary.

CONFIDENTIAL AND PROPRIETARY INFORMATION

This document contains confidential and proprietary information of Pulse Electronics, Inc. (Pulse) and is protected by copyright, trade secret and other state and federal laws. Its receipt or possession does not convey any rights to reproduce, disclose its contents, or to manufacture, use or sell anything it may describe. Reproduction, disclosure or use without specific written authorization of Pulse is strictly forbidden.

Description: ISM868/915MHz, 2.4GHz Ant

Series: PCB Embedded

PART NUMBER: W3331

CHARTS

Typical free space radiation pattern  
ISM2.4GHz  
X-Y plane

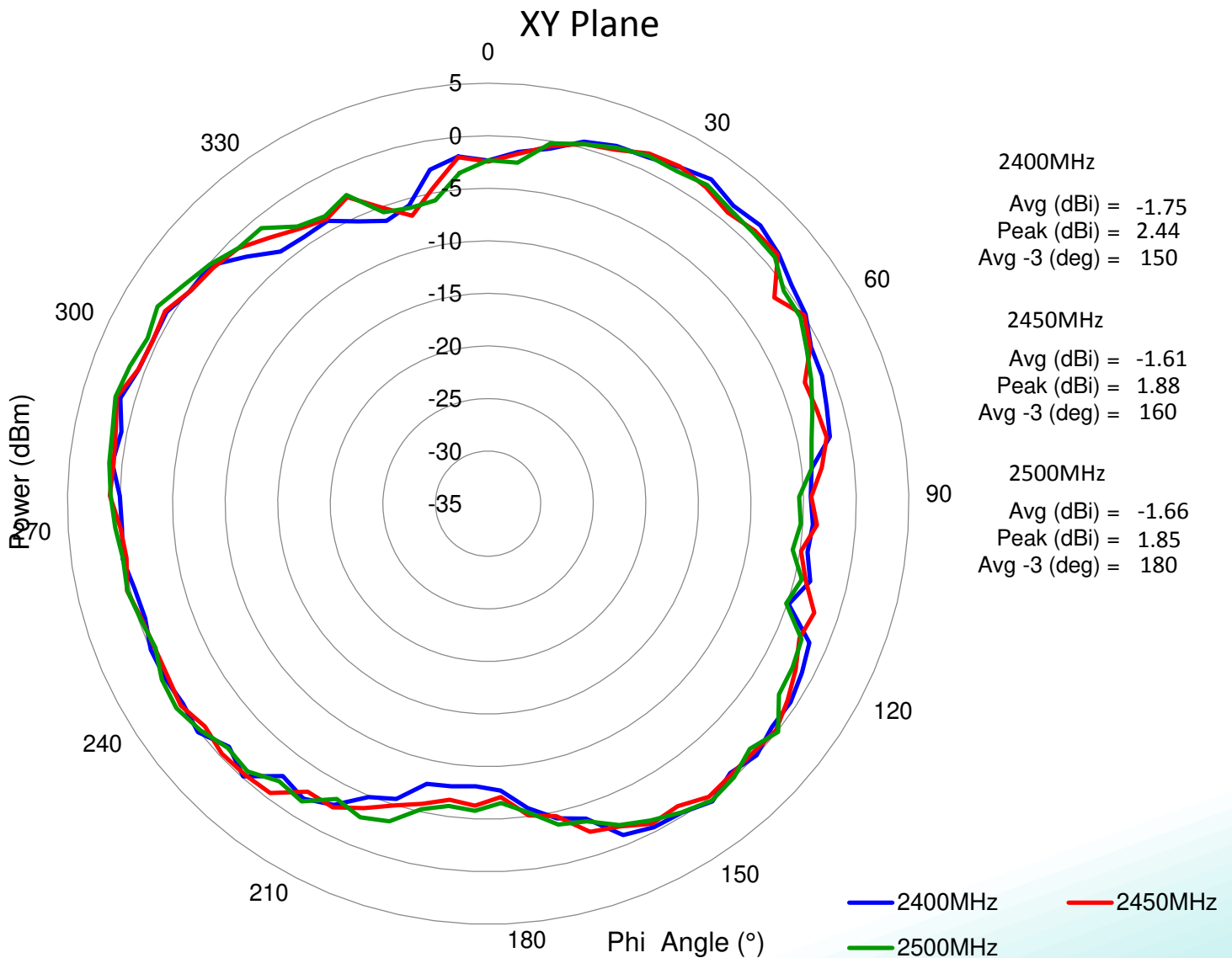

Issue: 1612

In the effort to improve our products, we reserve the right to make changes judged to be necessary.

CONFIDENTIAL AND PROPRIETARY INFORMATION

This document contains confidential and proprietary information of Pulse Electronics, Inc. (Pulse) and is protected by copyright, trade secret and other state and federal laws. Its receipt or possession does not convey any rights to reproduce, disclose its contents, or to manufacture, use or sell anything it may describe. Reproduction, disclosure or use without specific written authorization of Pulse is strictly forbidden.

Description: ISM868/915MHz, 2.4GHz Ant

Series: PCB Embedded

PART NUMBER: W3331

CHARTS

Typical free space radiation pattern  
ISM2.4GHz  
Z-X plane

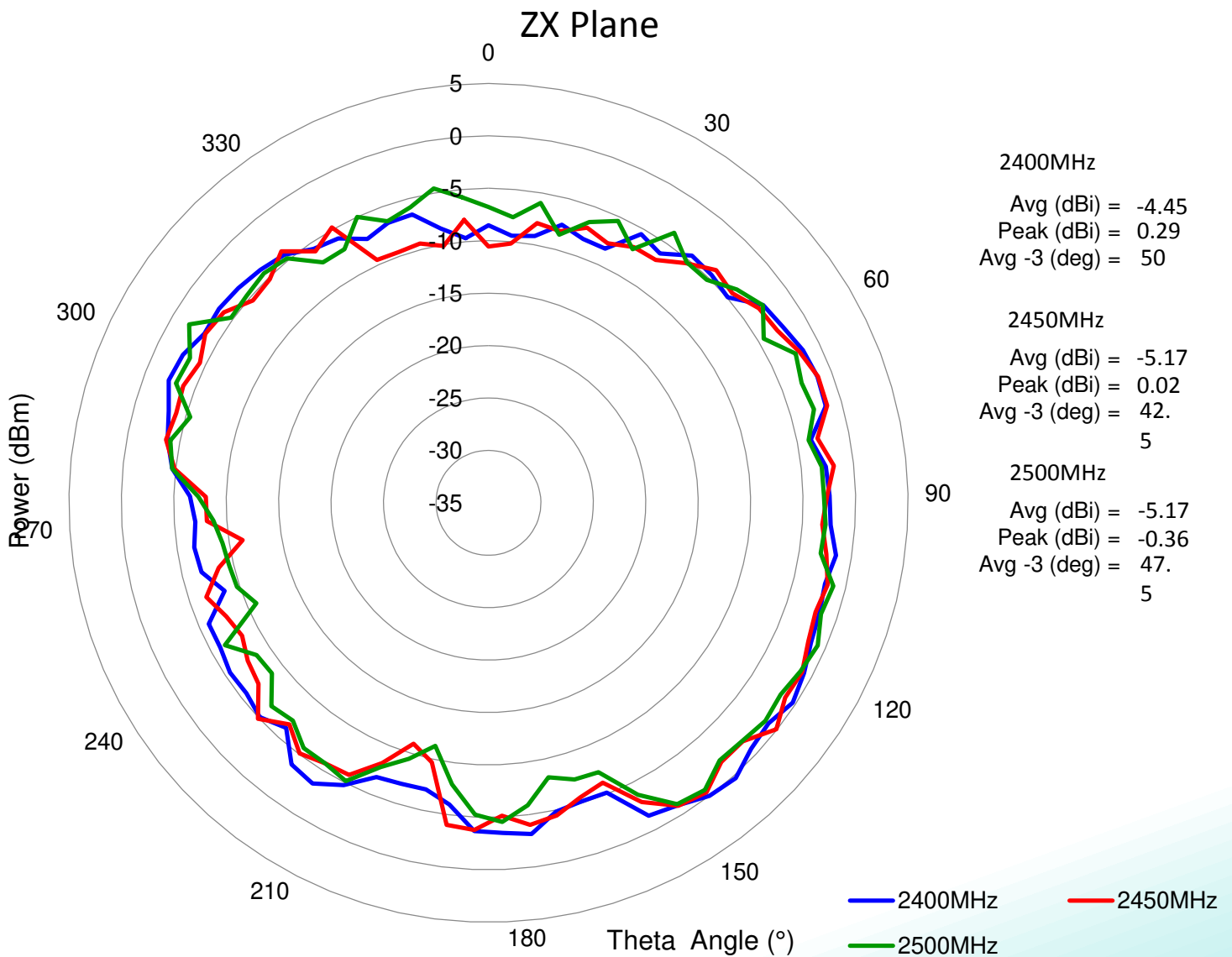

Issue: 1612

In the effort to improve our products, we reserve the right to make changes judged to be necessary.

CONFIDENTIAL AND PROPRIETARY INFORMATION

This document contains confidential and proprietary information of Pulse Electronics, Inc. (Pulse) and is protected by copyright, trade secret and other state and federal laws. Its receipt or possession does not convey any rights to reproduce, disclose its contents, or to manufacture, use or sell anything it may describe. Reproduction, disclosure or use without specific written authorization of Pulse is strictly forbidden.



Description: ISM868/915MHz, 2.4GHz Ant

Series: PCB Embedded

PART NUMBER: W3331

CHARTS

Typical free space radiation pattern  
ISM2.4GHz  
Z-Y plane

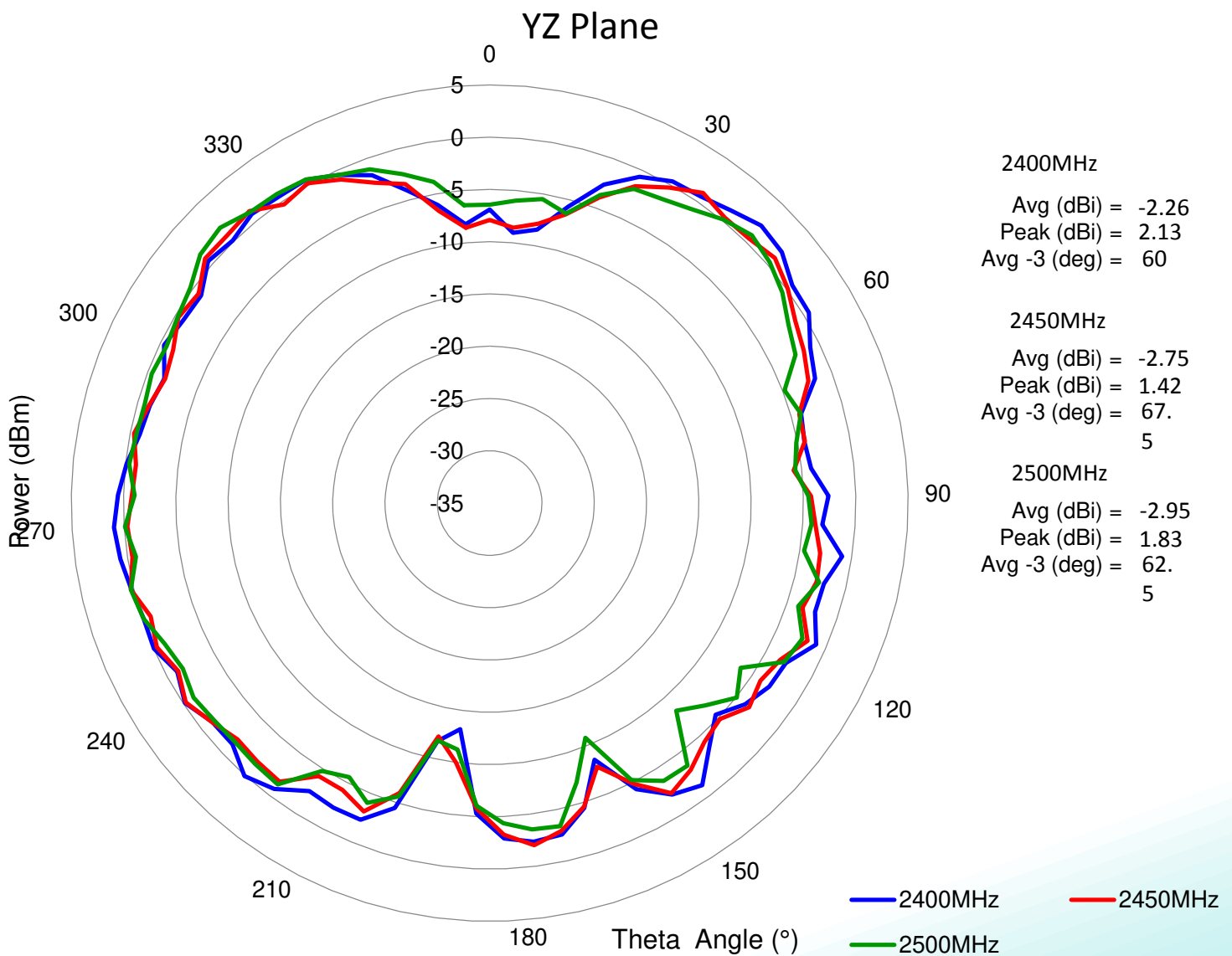

Issue: 1612

In the effort to improve our products, we reserve the right to make changes judged to be necessary.

CONFIDENTIAL AND PROPRIETARY INFORMATION

This document contains confidential and proprietary information of Pulse Electronics, Inc. (Pulse) and is protected by copyright, trade secret and other state and federal laws. Its receipt or possession does not convey any rights to reproduce, disclose its contents, or to manufacture, use or sell anything it may describe. Reproduction, disclosure or use without specific written authorization of Pulse is strictly forbidden.

Description: ISM868/915MHz, 2.4GHz Ant

Series: PCB Embedded

PART NUMBER: **W3331**

## PACKAGING

10PCS/PE bag

1000PCS/box

Issue: 1612

In the effort to improve our products, we reserve the right to make changes judged to be necessary.

CONFIDENTIAL AND PROPRIETARY INFORMATION

This document contains confidential and proprietary information of Pulse Electronics, Inc. (Pulse) and is protected by copyright, trade secret and other state and federal laws. Its receipt or possession does not convey any rights to reproduce, disclose its contents, or to manufacture, use or sell anything it may describe. Reproduction, disclosure or use without specific written authorization of Pulse is strictly forbidden.