

1N3070-1

FEATURES

- 1N3070-1 AVAILABLE IN JAN, JANTX, AND JANTXV PER MIL-PRF-19500/169
- SWITCHING DIODE
- METALLURGICALLY BONDED
- HERMETICALLY SEALED
- DOUBLE PLUG CONSTRUCTION

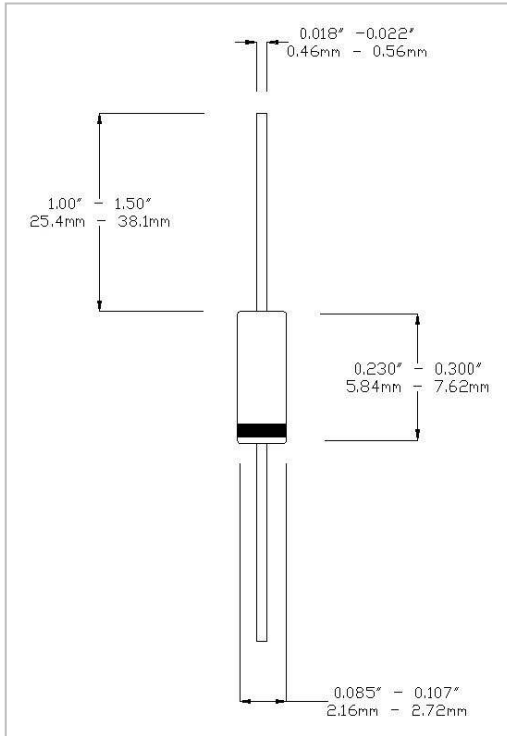

MAXIMUM RATINGS AT 25 °C

Operating Temperature:	-65°C to +175°C
Storage Temperature:	-65°C to +175°C
Surge Current A, sine, 1uS:	2.0A
Surge Current B, sine, 1S:	0.5A
Total Power Dissipation:	500mW
Operating Current:	100mA, T _A = +25°C
Derating Factor:	0.667mA/°C above T _A = +25°C
D.C. Reverse Voltage (VRWM):	175V

DC ELECTRICAL CHARACTERISTICS

V _F				I _R				V _{BR}			
Ambient (°C)	I _F mA	Min V	Max V	Ambient (°C)	V (dc)	Min μA	Max μA	Ambient (°C)	I _R μA	Min V	Max V
25	100	-	1.0	25	175	-	0.1	25	100	200	-
-55	100	-	1.2	150	175	-	100				

DESIGN DATA

Case: Hermetically sealed glass package per MIL-PRF-19500/169 DO-7 outline

Lead Material: Copper clad steel

Lead Finish: Tin/Lead

Thermal Resistance (R_{θJL}): 250°C/W maximum at L=.375"

Thermal Impedance (Z_{θJX}): 70°C/W maximum

Marking: Alpha numeric.

Polarity: Cathode end is banded.

AC ELECTRICAL CHARACTERISTICS AT 25°C

	Symbol	Min	Max
Capacitance @ 0V	pF	-	5
T _{RR} @ I _F =I _R =30mA, I _{Rec} = 3mA.	nsec	-	50



WWW.MICROSEMI.COM

IRELAND - GORT ROAD, ENNIS, CO. CLARE

PHONE: +353 65 6840044

TOLL FREE: +186 62 702434

FAX: +353 65 6822298

U.S.A. DOMESTIC SALES CONTACT

PHONE: (617) 926 0404

TOLL FREE: 1 800 666 2999