

Flush-type connector - SACC-DSI-FSB-5CON-L180/12 SCO - 1552298

Please be informed that the data shown in this PDF Document is generated from our Online Catalog. Please find the complete data in the user's documentation. Our General Terms of Use for Downloads are valid (<http://download.phoenixcontact.com>)



Sensor/actuator flush-type socket, 5-pos., M12 SPEEDCON, B-coded, rear/screw mounting with Pg9 thread, with straight solder connection, design with 12 mm long solder pins



Key commercial data

Packing unit	1 PCE
Minimum order quantity	20 PCE
Weight per Piece (excluding packing)	14.55 GRM
Custom tariff number	85366990
Country of origin	Germany

Technical data

Dimensions

Length of the solder pin	12 mm
--------------------------	-------

Ambient conditions

Ambient temperature (operation)	-25 °C ... 85 °C (Plug / socket)
Degree of protection	IP67

General

Rated current at 40°C	4 A
Rated voltage	60 V
Number of positions	5
Contact resistance	≤ 3 mΩ
Insulation resistance	≥ 100 MΩ
Coding	B - inverse
Standards/regulations	M12 connector IEC 61076-2-101
Status display	No

Flush-type connector - SACC-DSI-FSB-5CON-L180/12 SCO - 1552298

Technical data

General

Surge voltage category	II
Pollution degree	3
Connection method	Solder pins
Mounting type	Rear mounting Pg9 With flat nut

Material

Inflammability class according to UL 94	V0
Contact material	CuZn
Contact surface material	Au
Contact carrier material	PA 66
Material, knurls	Zinc die-cast, nickel-plated
Sealing material	NBR

Classifications

eCl@ss

eCl@ss 4.0	27250313
eCl@ss 4.1	27250313
eCl@ss 5.0	27143423
eCl@ss 5.1	27143423
eCl@ss 6.0	27143423
eCl@ss 7.0	27449001
eCl@ss 8.0	27449001

ETIM

ETIM 3.0	EC002061
ETIM 4.0	EC002061
ETIM 5.0	EC002061

UNSPSC

UNSPSC 6.01	31261501
UNSPSC 7.0901	31261501
UNSPSC 11	31261501
UNSPSC 12.01	31261501
UNSPSC 13.2	31261501

Approvals

Approvals

Flush-type connector - SACC-DSI-FSB-5CON-L180/12 SCO - 1552298

Approvals

Approvals

UL Recognized / GOST / GOST

Ex Approvals

Approvals submitted

Approval details

UL Recognized 	
mm ² /AWG/kcmil	26-20
Nominal current I _N	4 A
Nominal voltage U _N	60 V

GOST 

GOST 

Drawings

Flush-type connector - SACC-DSI-FSB-5CON-L180/12 SCO - 1552298

Dimensioned drawing

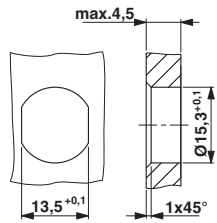

Schematic diagram

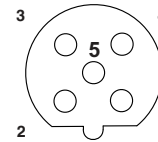

Pin assignment M12 socket, 5-pos., B-coded, female side

Housing cutout for Pg9 fastening thread, mounting panel with feed-through hole (alternatively with surface as protection against rotation)

Drilling diagram

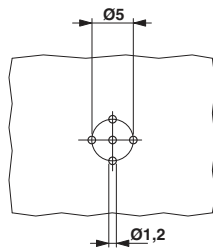

Dimensioned drawing

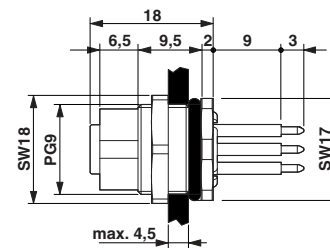

M12 flush-type connector

Dimensioned drawing

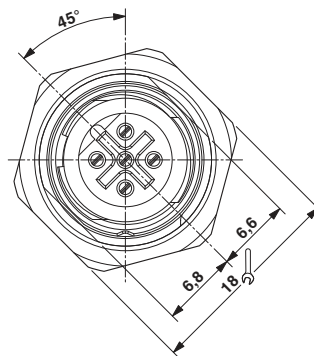

M12 front view