

**X2-Class
HiPerFET™
Power MOSFET**

IXFH80N65X2-4

V_{DSS} = 650V
I_{D25} = 80A
R_{DS(on)} ≤ 38mΩ

N-Channel Enhancement Mode
 Avalanche Rated
 Fast Intrinsic Diode

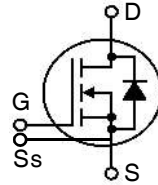

TO-247-4L

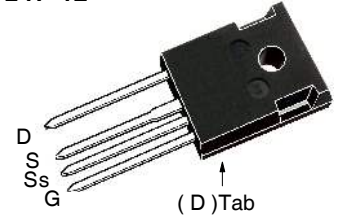

S = Source G = Gate
 D = Drain Ss = Source Sense

| Symbol | Test Conditions | Maximum Ratings | |
|-------------------|--|-----------------|----------|
| V _{DSS} | T _J = 25°C to 150°C | 650 | V |
| V _{DGR} | T _J = 25°C to 150°C, R _{GS} = 1MΩ | 650 | V |
| V _{GSS} | Continuous | ±30 | V |
| V _{GSM} | Transient | ±40 | V |
| I _{D25} | T _C = 25°C | 80 | A |
| I _{DM} | T _C = 25°C, Pulse Width Limited by T _{JM} | 160 | A |
| I _A | T _C = 25°C | 20 | A |
| E _{AS} | T _C = 25°C | 3 | J |
| dv/dt | I _S ≤ I _{DM} , V _{DD} ≤ V _{DSS} , T _J ≤ 150°C | 50 | V/ns |
| P _D | T _C = 25°C | 890 | W |
| T _J | | -55 ... +150 | °C |
| T _{JM} | | 150 | °C |
| T _{stg} | | -55 ... +150 | °C |
| T _L | Maximum Lead Temperature for Soldering | 300 | °C |
| T _{SOLD} | 1.6 mm (0.062in.) from Case for 10s | 260 | °C |
| M _d | Mounting Torque | 1.13 / 10 | Nm/lb.in |
| Weight | | 6 | g |

Features

- International Standard Package
- Low R_{DS(ON)} and Q_G
- Avalanche Rated
- Low Package Inductance

Advantages

- High Power Density
- Easy to Mount
- Space Savings

Applications

- Switch-Mode and Resonant-Mode Power Supplies
- DC-DC Converters
- PFC Circuits
- AC and DC Motor Drives
- Robotics and Servo Controls

| Symbol | Test Conditions (T _J = 25°C, Unless Otherwise Specified) | Characteristic Values | | |
|---------------------|---|-----------------------|------|---------------|
| | | Min. | Typ. | Max. |
| BV _{DSS} | V _{GS} = 0V, I _D = 1mA | 650 | | V |
| V _{GS(th)} | V _{DS} = V _{GS} , I _D = 4mA | 3.5 | | 5.0 V |
| I _{GSS} | V _{GS} = ±30V, V _{DS} = 0V | | | ±100 nA |
| I _{DSS} | V _{DS} = V _{DSS} , V _{GS} = 0V T _J = 125°C | | | 50 μA 3 mA |
| R _{DS(on)} | V _{GS} = 10V, I _D = 0.5 • I _{D25} , Note 1 | | | 38 mΩ |

| Symbol | Test Conditions ($T_J = 25^\circ\text{C}$, Unless Otherwise Specified) | Characteristic Values | | |
|-------------------------------------|--|--|------|-------------------------|
| | | Min. | Typ. | Max |
| g_{fs} | $V_{DS} = 10\text{V}$, $I_D = 0.5 \cdot I_{D25}$, Note 1 | 33 | 55 | S |
| R_{Gi} | Gate Input Resistance | | 0.6 | Ω |
| C_{iss} | } $V_{GS} = 0\text{V}$, $V_{DS} = 25\text{V}$, $f = 1\text{MHz}$ | | 8300 | pF |
| C_{oss} | | | 5010 | pF |
| C_{rss} | | | 1.6 | pF |
| Effective Output Capacitance | | | | |
| $C_{o(er)}$ | Energy related | } $V_{GS} = 0\text{V}$ $V_{DS} = 0.8 \cdot V_{DSS}$ | 280 | pF |
| $C_{o(tr)}$ | Time related | | 1160 | pF |
| Resistive Switching Times | | | | |
| $t_{d(on)}$ | } $V_{GS} = 10\text{V}$, $V_{DS} = 0.5 \cdot V_{DSS}$, $I_D = 0.5 \cdot I_{D25}$ $R_G = 3\Omega$ (External) | | 32 | ns |
| t_r | | | 24 | ns |
| $t_{d(off)}$ | | | 70 | ns |
| t_f | | | 11 | ns |
| $Q_{g(on)}$ | } $V_{GS} = 10\text{V}$, $V_{DS} = 0.5 \cdot V_{DSS}$, $I_D = 0.5 \cdot I_{D25}$ | | 140 | nC |
| Q_{gs} | | | 50 | nC |
| Q_{gd} | | | 40 | nC |
| R_{thJC} | | | | 0.14 $^\circ\text{C/W}$ |
| R_{thCS} | | 0.21 | | $^\circ\text{C/W}$ |

Source-Drain Diode

| Symbol | Test Conditions ($T_J = 25^\circ\text{C}$, Unless Otherwise Specified) | Characteristic Values | | |
|----------|--|-----------------------|------|---------------|
| | | Min. | Typ. | Max |
| I_S | $V_{GS} = 0\text{V}$ | | | 80 A |
| I_{SM} | Repetitive, Pulse Width Limited by T_{JM} | | | 320 A |
| V_{SD} | $I_F = I_S$, $V_{GS} = 0\text{V}$, Note 1 | | | 1.4 V |
| t_{rr} | } $I_F = 40\text{A}$, $-di/dt = 100\text{A}/\mu\text{s}$ $V_R = 100\text{V}$ | | 200 | ns |
| Q_{RM} | | | 1.7 | μC |
| I_{RM} | | | 16.7 | A |

Note 1. Pulse test, $t \leq 300\mu\text{s}$, duty cycle, $d \leq 2\%$.

IXYS Reserves the Right to Change Limits, Test Conditions, and Dimensions.

| | | | | | | | | | | |
|--|-----------|-----------|-----------|-----------|-------------|-------------|-------------|-------------|-------------|-------------|
| IXYS MOSFETs and IGBTs are covered by one or more of the following U.S. patents: | 4,835,592 | 4,931,844 | 5,049,961 | 5,237,481 | 6,162,665 | 6,404,065B1 | 6,683,344 | 6,727,585 | 7,005,734B2 | 7,157,338B2 |
| | 4,860,072 | 5,017,508 | 5,063,307 | 5,381,025 | 6,259,123B1 | 6,534,343 | 6,710,405B2 | 6,759,692 | 7,063,975B2 | |
| | 4,881,106 | 5,034,796 | 5,187,117 | 5,486,715 | 6,306,728B1 | 6,583,505 | 6,710,463 | 6,771,478B2 | 7,071,537 | |

Fig. 1. Output Characteristics @ $T_J = 25^\circ\text{C}$

Fig. 2. Extended Output Characteristics @ $T_J = 25^\circ\text{C}$

Fig. 3. Output Characteristics @ $T_J = 125^\circ\text{C}$

Fig. 4. $R_{DS(on)}$ Normalized to $I_D = 40\text{A}$ Value vs. Junction Temperature

Fig. 5. $R_{DS(on)}$ Normalized to $I_D = 40\text{A}$ Value vs. Drain Current

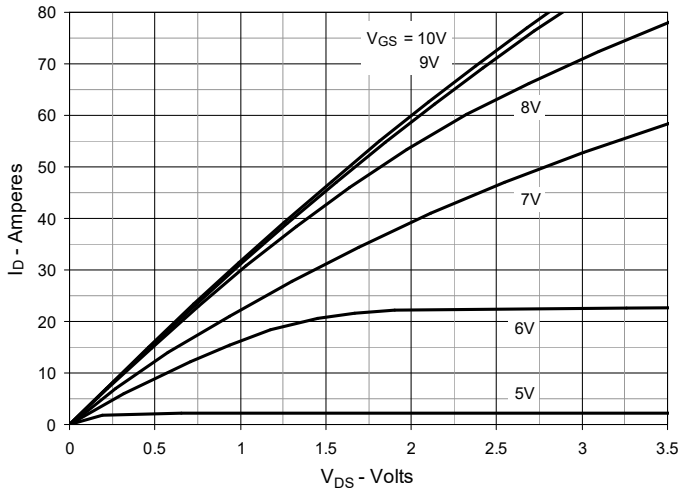
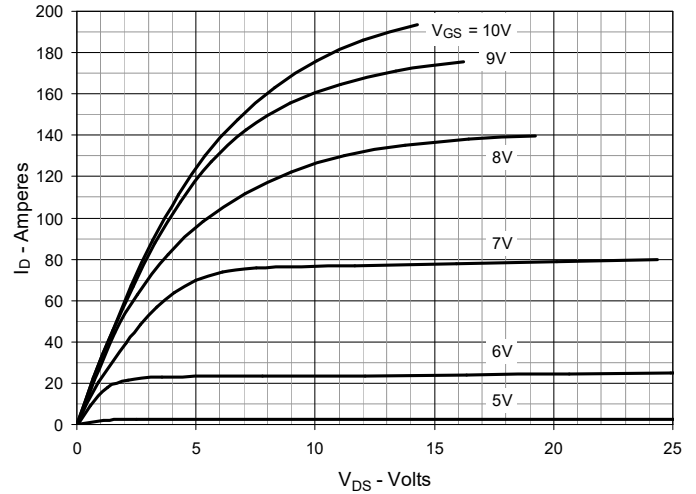
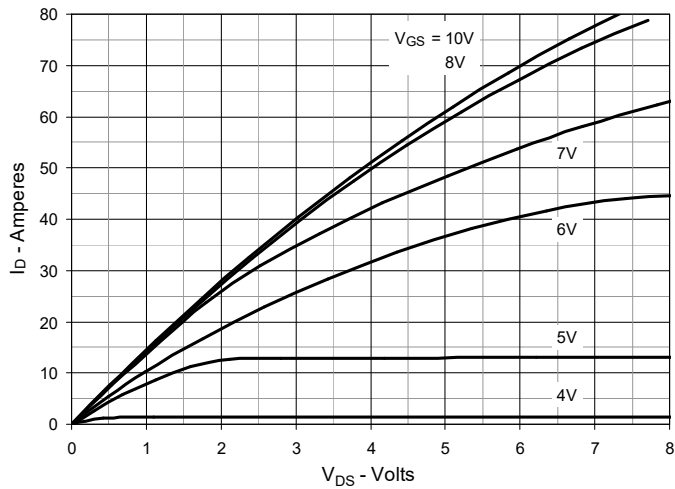
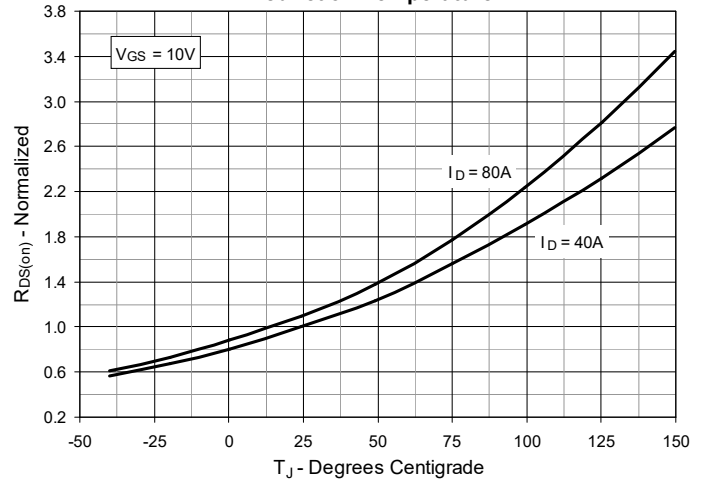
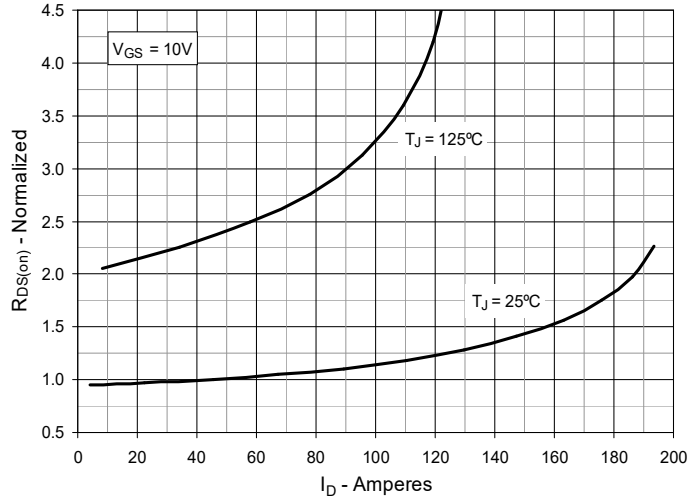
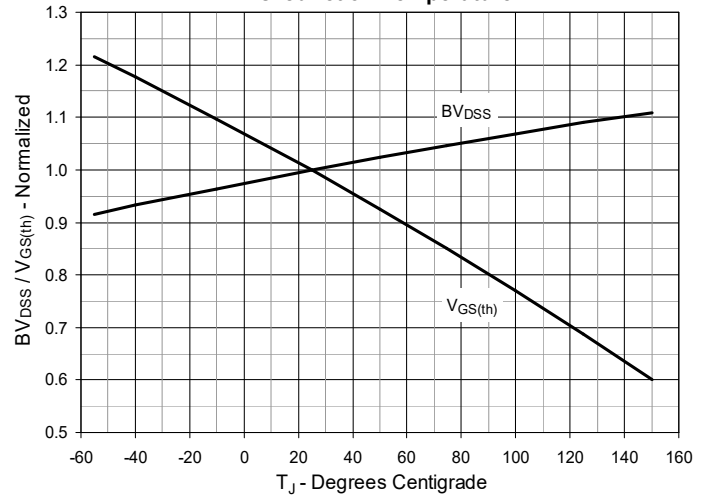
Fig. 6. Normalized Breakdown & Threshold Voltages vs. Junction Temperature

Fig. 7. Maximum Drain Current vs. Case Temperature

Fig. 8. Input Admittance

Fig. 9. Transconductance

Fig. 10. Forward Voltage Drop of Intrinsic Diode

Fig. 11. Gate Charge

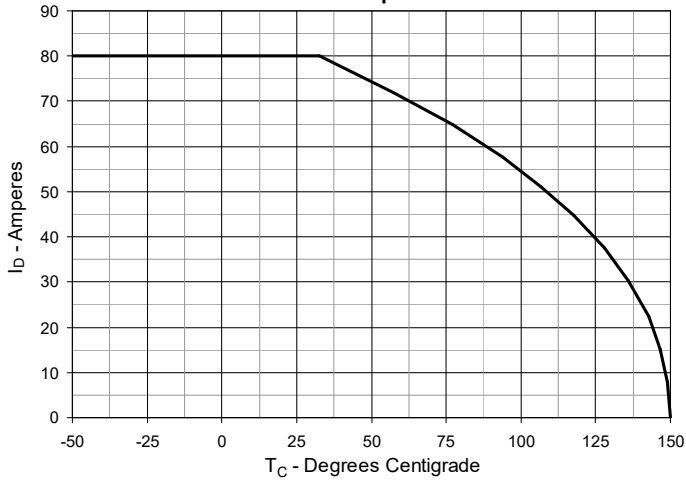
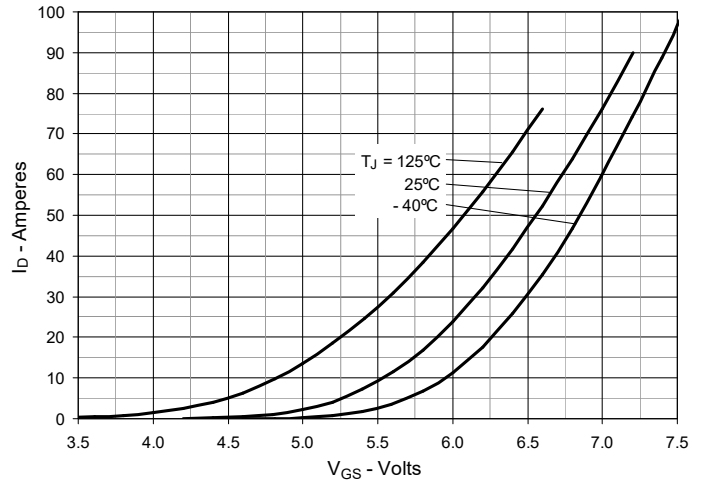
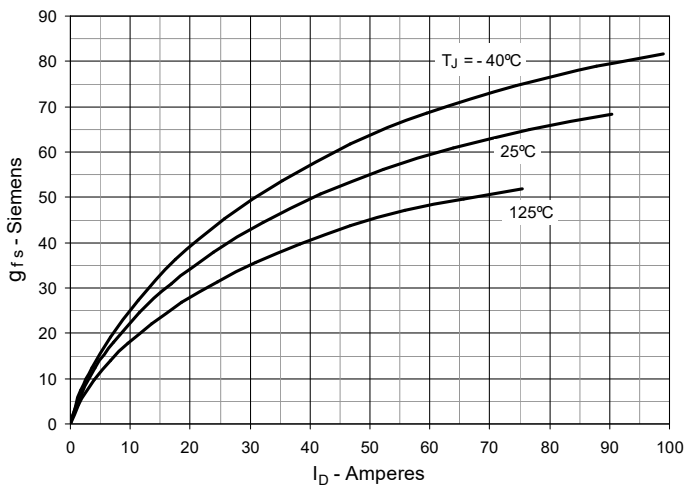
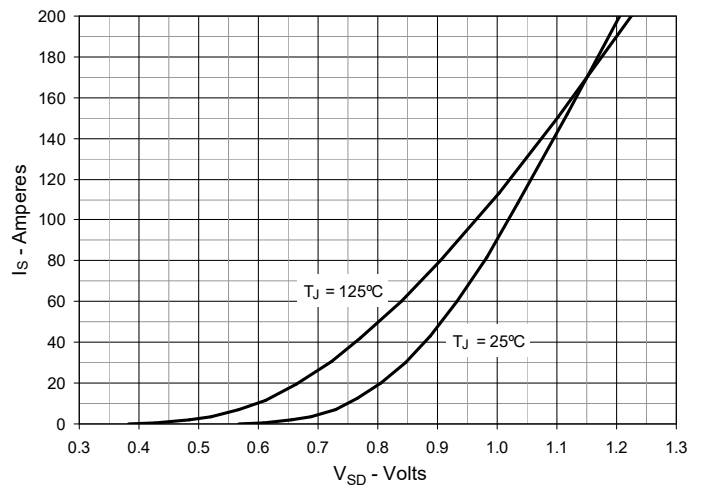
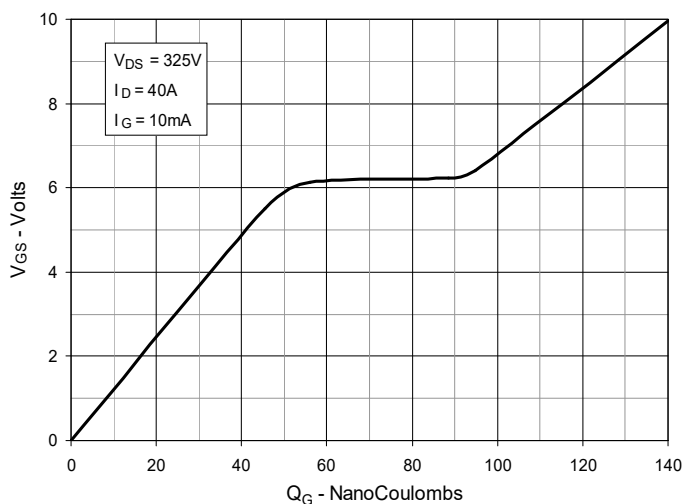
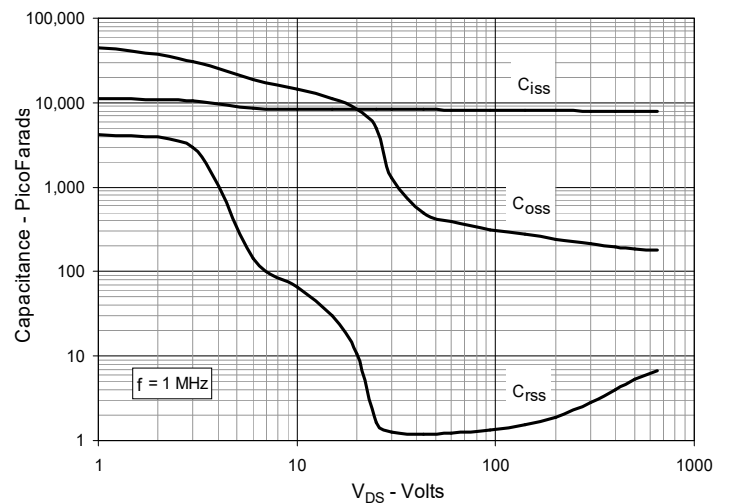
Fig. 12. Capacitance

Fig. 13. Output Capacitance Stored Energy

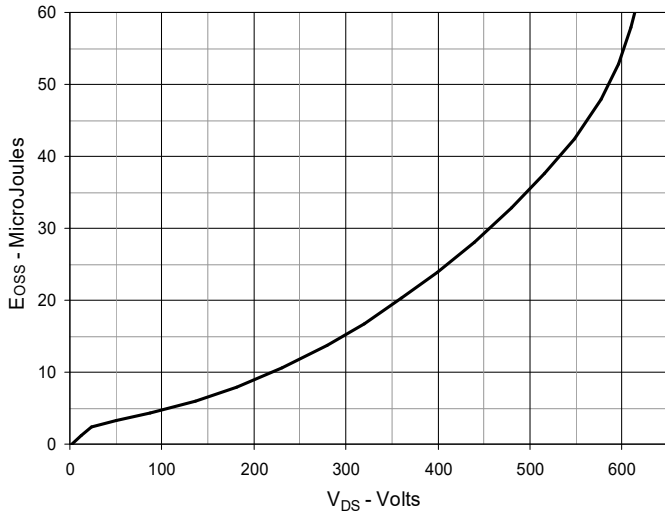

Fig. 14. Forward-Bias Safe Operating Area

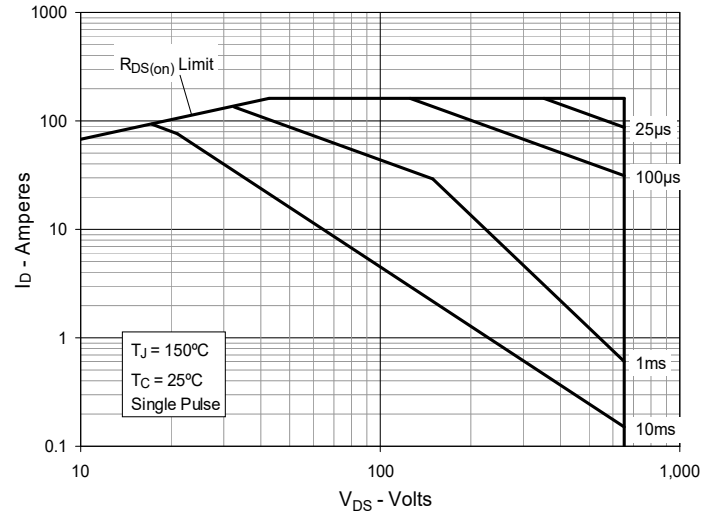
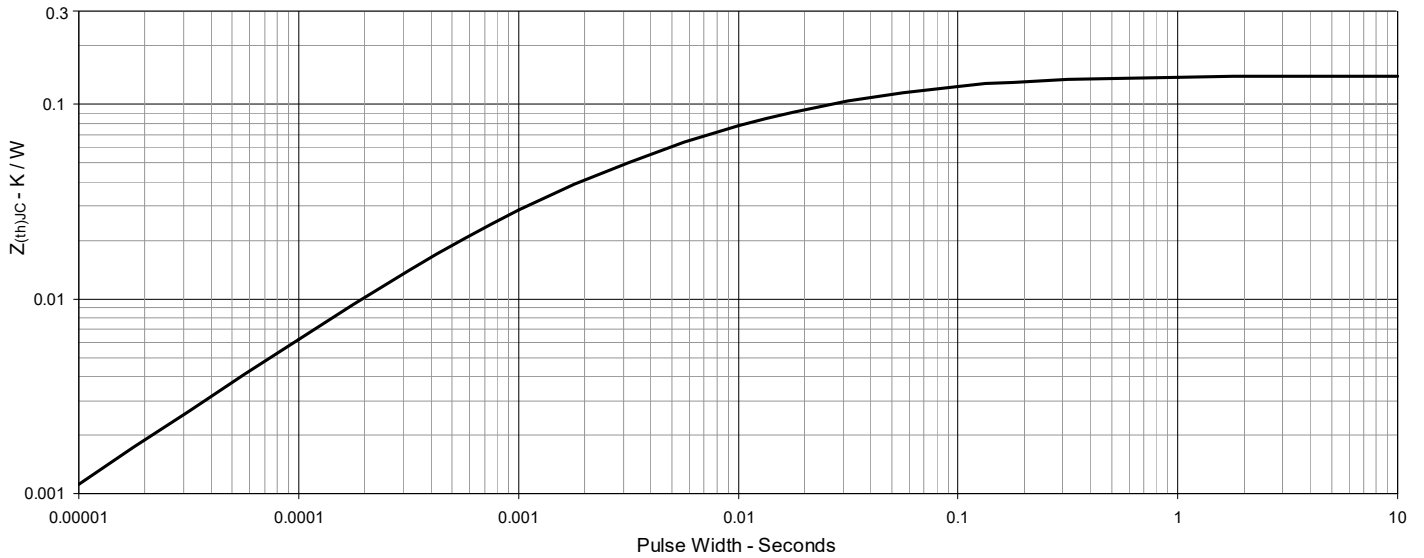
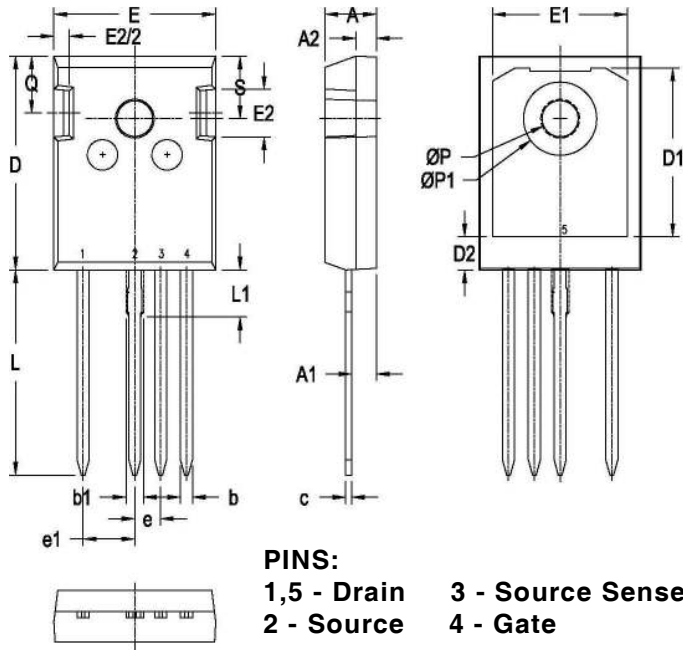

Fig. 15. Maximum Transient Thermal Impedance



TO-247 - 4L Outline

| SYM | INCHES | | MILLIMETERS | |
|-----|----------|------|-------------|-------|
| | MIN | MAX | MIN | MAX |
| A | .189 | .205 | 4.80 | 5.20 |
| A1 | .090 | .098 | 2.30 | 2.50 |
| A2 | .075 | .083 | 1.90 | 2.10 |
| b | .043 | .055 | 1.10 | 1.40 |
| b1 | .063 | .071 | 1.60 | 1.80 |
| c | .020 | .031 | 0.50 | 0.80 |
| D | .819 | .839 | 20.80 | 21.30 |
| D1 | .630 | .670 | 16.00 | 17.00 |
| D2 | .118 | .138 | 3.00 | 3.50 |
| E | .620 | .636 | 15.75 | 16.15 |
| E1 | .531 | .559 | 13.50 | 14.20 |
| E2 | .169 | .193 | 4.30 | 4.90 |
| e | .100 BSC | | 2.54 BSC | |
| e1 | .200 BSC | | 5.08 BSC | |
| L | .780 | .799 | 19.80 | 20.30 |
| L1 | .157 | .177 | 4.00 | 4.50 |
| ØP | .140 | .144 | 3.55 | 3.65 |
| ØP1 | .280 | .287 | 7.10 | 7.30 |
| Q | .213 | .236 | 5.40 | 6.00 |
| S | .242 BSC | | 6.15 BSC | |



Disclaimer Notice - Information furnished is believed to be accurate and reliable. However, users should independently evaluate the suitability of and test each product selected for their own applications. Littelfuse products are not designed for, and may not be used in, all applications. Read complete Disclaimer Notice at www.littelfuse.com/disclaimer-electronics.
