

## 60A, 40V Schottky Barrier Surface Mount Rectifier

### FEATURES

- Low power loss, high efficiency
- Ideal for automated placement
- Guard ring for overvoltage protection
- High surge current capability
- Moisture sensitivity level: level 1, per J-STD-020
- RoHS Compliant
- Halogen-free according to IEC 61249-2-21

### APPLICATIONS

- Switching mode power supply (SMPS)
- Adapters
- DC to DC converters

### MECHANICAL DATA

- Case: TO-263AB (D<sup>2</sup>PAK)
- Molding compound meets UL 94V-0 flammability rating
- Terminal: Matte tin plated leads, solderable per J-STD-002
- Meet JESD 201 class 2 whisker test
- Polarity: As marked
- Weight: 1.70g (approximately)

KEY PARAMETERS		
PARAMETER	VALUE	UNIT
$I_F$	60	A
$V_{RRM}$	40	V
$I_{FSM}$	250	A
$T_{JMAX}$	150	°C
Package	TO-263AB (D <sup>2</sup> PAK)	
Configuration	Dual dies	

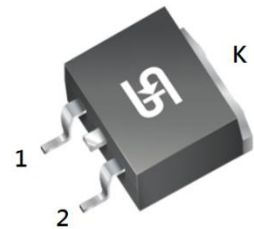

**TO-263AB (D<sup>2</sup>PAK)**

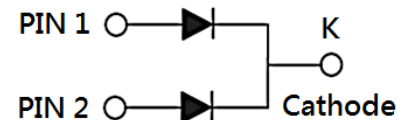

ABSOLUTE MAXIMUM RATINGS ( $T_A = 25^\circ\text{C}$ unless otherwise noted)			
PARAMETER	SYMBOL	MBRS6040CT	UNIT
Marking code on the device		MBRS6040CT	
Repetitive peak reverse voltage	$V_{RRM}$	40	V
Reverse voltage, total rms value	$V_{R(RMS)}$	28	V
Forward current	$I_F$	60	A
Surge peak forward current, 8.3ms single half sine wave superimposed on rated load	$I_{FSM}$	250	A
Critical rate of rise of off-state voltage	dv/dt	10,000	V/ $\mu\text{s}$
Junction temperature	$T_J$	-55 to +150	°C
Storage temperature	$T_{STG}$	-55 to +150	°C

<b>THERMAL PERFORMANCE</b>			
PARAMETER	SYMBOL	TYP	UNIT
Junction-to-case thermal resistance	$R_{\theta JC}$	1	°C/W

<b>ELECTRICAL SPECIFICATIONS</b> ( $T_A = 25^\circ\text{C}$ unless otherwise noted)					
PARAMETER	CONDITIONS	SYMBOL	TYP	MAX	UNIT
Forward voltage per diode <sup>(1)</sup>	$I_F = 30\text{A}, T_J = 25^\circ\text{C}$	$V_F$	-	0.75	V
	$I_F = 60\text{A}, T_J = 25^\circ\text{C}$		-	1.05	V
	$I_F = 30\text{A}, T_J = 125^\circ\text{C}$		-	0.70	V
	$I_F = 60\text{A}, T_J = 125^\circ\text{C}$		-	0.98	V
Reverse current @ rated $V_R$ per diode <sup>(2)</sup>	$T_J = 25^\circ\text{C}$	$I_R$	-	100	μA
	$T_J = 125^\circ\text{C}$		-	40	mA

**Notes:**

1. Pulse test with PW = 0.3ms
2. Pulse test with PW = 30ms

<b>ORDERING INFORMATION</b>		
ORDERING CODE	PACKAGE	PACKING
MBRS6040CT	TO-263AB (D <sup>2</sup> PAK)	800 / Tape & Reel

**CHARACTERISTICS CURVES**

( $T_A = 25^\circ\text{C}$  unless otherwise noted)

**Fig.1 Forward Current Derating Curve**

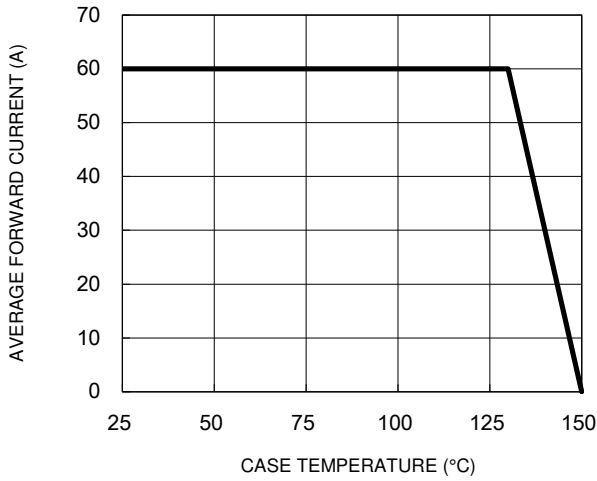

**Fig.2 Typical Junction Capacitance**

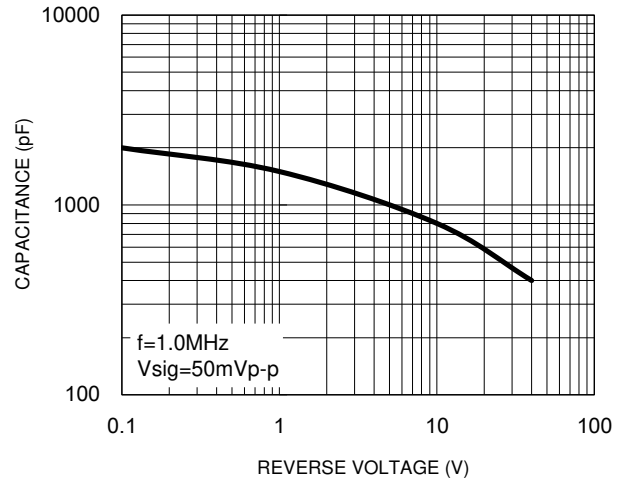

**Fig.3 Typical Reverse Characteristics**

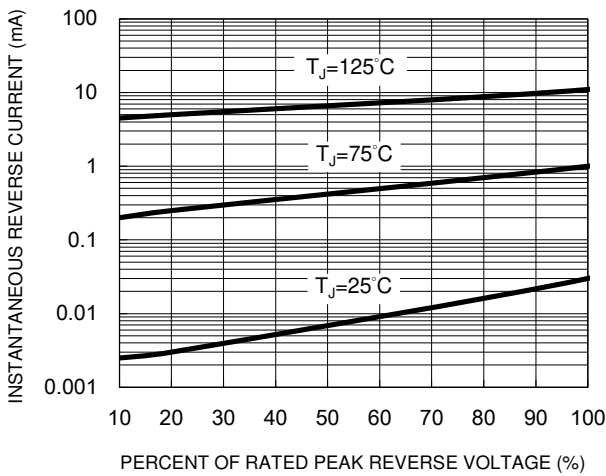

**Fig.4 Typical Forward Characteristics**

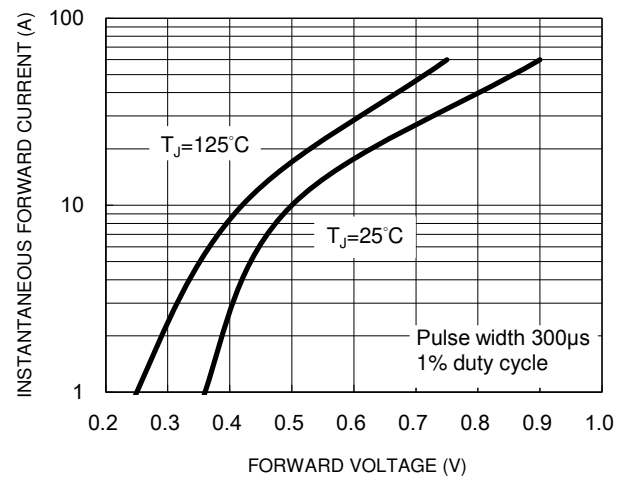

**Fig.5 Maximum Non-Repetitive Forward Surge Current**

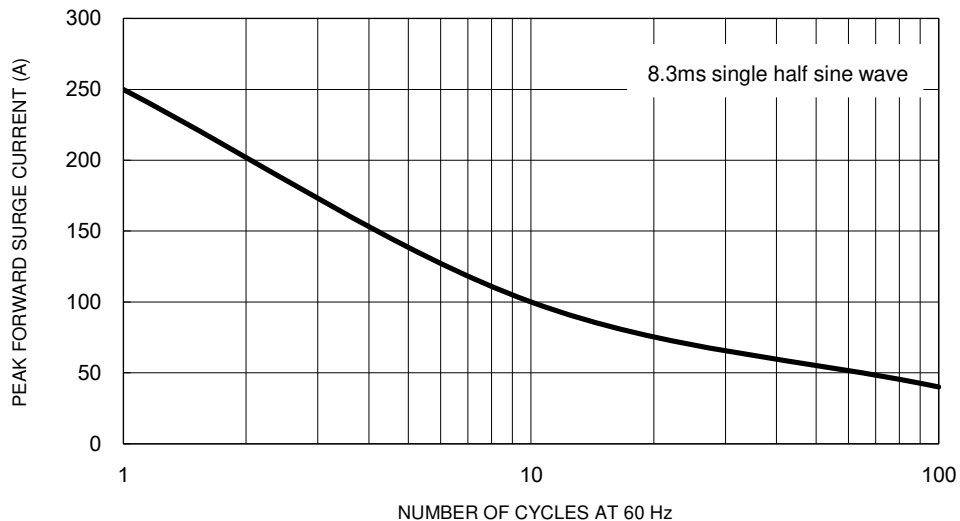

**CHARACTERISTICS CURVES**

( $T_A = 25^\circ\text{C}$  unless otherwise noted)

**Fig.6 Typical Transient Thermal Impedance**

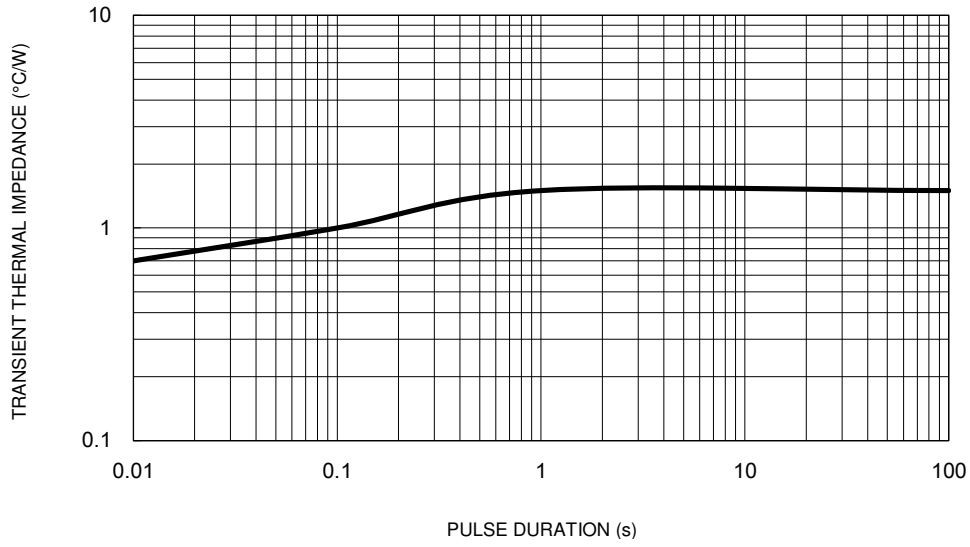

**PACKAGE OUTLINE DIMENSIONS**

TO-263AB (D<sup>2</sup>PAK)

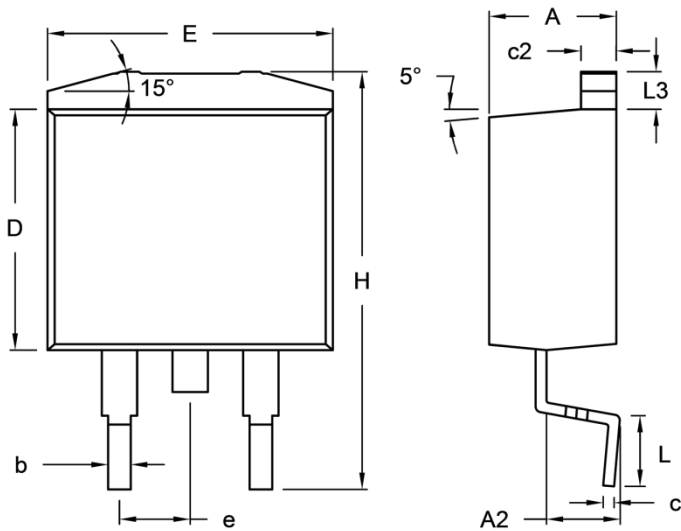

DIM.	Unit (mm)		Unit (inch)	
	Min.	Max.	Min.	Max.
A	4.44	4.70	0.175	0.185
A2	2.03	2.79	0.080	0.110
b	0.68	0.94	0.027	0.037
c	0.36	0.53	0.014	0.021
c2	1.14	1.40	0.045	0.055
D	8.25	9.25	0.325	0.364
E	-	10.50	-	0.413
e	2.41	2.67	0.095	0.105
H	14.60	15.88	0.575	0.625
L	2.29	2.79	0.090	0.110
L3	1.14	1.40	0.045	0.055

**SUGGESTED PAD LAYOUT**

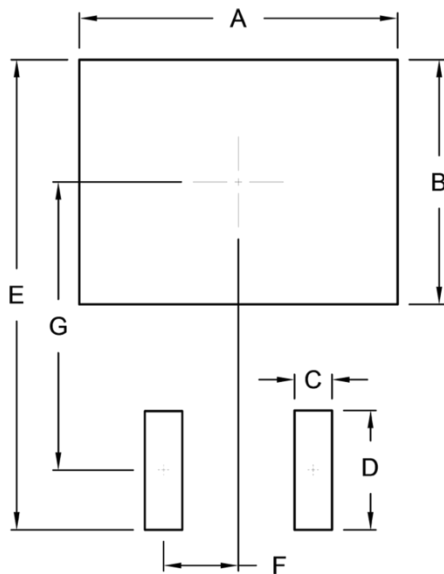

Symbol	Unit (mm)	Unit (inch)
A	10.80	0.425
B	8.30	0.327
C	1.27	0.050
D	4.05	0.159
E	15.95	0.628
F	2.54	0.100
G	9.775	0.385

**MARKING DIAGRAM**



- P/N = Marking Code
- G = Green Compound
- YWW = Date Code
- F = Factory Code

## **Notice**

Specifications of the products displayed herein are subject to change without notice. TSC or anyone on its behalf assumes no responsibility or liability for any errors or inaccuracies.

Purchasers are solely responsible for the choice, selection, and use of TSC products and TSC assumes no liability for application assistance or the design of Purchasers' products.

Information contained herein is intended to provide a product description only. No license, express or implied, to any intellectual property rights is granted by this document. Except as provided in TSC's terms and conditions of sale for such products, TSC assumes no liability whatsoever, and disclaims any express or implied warranty, relating to sale and/or use of TSC products including liability or warranties relating to fitness for a particular purpose, merchantability, or infringement of any patent, copyright, or other intellectual property right.

The products shown herein are not designed for use in medical, life-saving, or life-sustaining applications. Customers using or selling these products for use in such applications do so at their own risk and agree to fully indemnify TSC for any damages resulting from such improper use or sale.