

Data Sheet

Customer:

Product: Metal Film Precision Resistor-CSR Series

Size: 0204/ 0207

Issued Date: 15-Jun-22

Edition: REV.D4



VIKING TECH CORPORATION
光頡科技股份有限公司
No.70 Guangfu N. Rd., Hukou
Township, Hsinchu County 303,
Taiwan

TEL:886-3-5972931
FAX:886-3-5972935•886-3-5973494
E-mail:sales@viking.com.tw

VIKING TECH CORPORATION KAOHSIUNG BRANCH
光頡科技股份有限公司高雄分公司
No.248-3, Sin-Sheng Rd., Cian-Jhen Dist., Kaohsiung,
806, Taiwan

TEL:886-7-8217999
FAX:886-7-8228229
E-mail:sales@viking.com.tw

VIKING ELECTRONICS (WUXI) CO., LTD.
光頡電子(無錫)有限公司
No.22 Xixia Road, Machinery & Industry Park,
National Hi-Tech Industrial Development Zone
of Wuxi, Wuxi, Jiangsu Province, China
Zip Code:214028
TEL:86-510-85203339
FAX:86-510-85203667•86-510-85203977
E-mail:china@viking.com.tw

| Produced by (QC) | Checked (QC) | Approved by (QC) | Prepared by (Sales) | Accepted by (Customer) |
|---------------------|--------------------|---------------------|------------------------|---------------------------|
| 15-Jun-22 | 15-Jun-22 | 15-Jun-22 | | |
| Alice Hsiao | Susan Huang | Susan Huang | | |

Metal Film Precision Resistor
Metal Film Precision Resistor



■Features

- Excellent overall stability
- Tight tolerance down to $\pm 0.1\%$
- Extremely low TCR down to $\pm 5 \text{ PPM}/^\circ\text{C}$
- High power rating up to 1 Watts

■Applications

- Telecommunication
- Medical Equipment
- Measurement/Testing Equipment

■Construction & Dimension

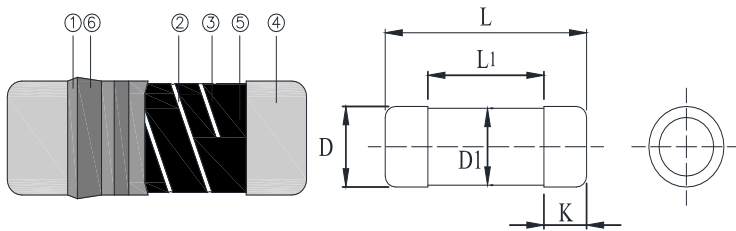

| | |
|----------------------|------------------|
| ① Insulation Coating | ④ Electrode Cap |
| ② Trimming Line | ⑤ Resistor Layer |
| ③ Ceramic Rod | ⑥ Marking |

| Type | L (mm) | L _{1 min.} (mm) | ΦD (mm) | ΦD ₁ (mm) | K (mm) | Weight 1,000EA (g) |
|---------|----------|--------------------------|-----------|----------------------|---------|--------------------|
| CSR0204 | 3.50±0.2 | 1.7 | 1.40±0.15 | D +0/-0.2 | 0.8±0.1 | 18.7 |
| CSR0207 | 5.90±0.2 | 2.9 | 2.20±0.20 | D +0/-0.2 | 1.3±0.1 | 80.9 |

■Derating Curve

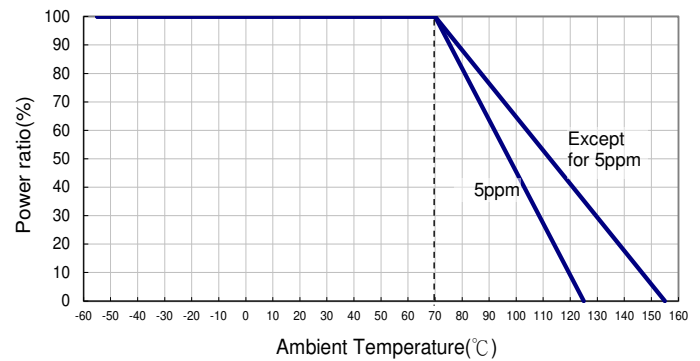

■Part Numbering

| Product Type | Dimensions (L×ΦD) | Resistance Tolerance | Packaging Code | TCR (PPM/°C) | Power Rating | Resistance |
|--------------------------------|---|--|--|--|---|------------|
| CSR | 0204 | D | T | D | V | 1000 |
| 0204: 3.5x1.4 0207: 5.9x2.2 | B: $\pm 0.1\%$ C: $\pm 0.25\%$ D: $\pm 0.5\%$ F: $\pm 1\%$ J: $\pm 5\%$ | T: 7" Taping Reel S: 7" Taping Reel, Antistatic Tape* W: 13" Taping Reel M: 13" Taping Reel, Antistatic Tape* | S: ± 5 B: ± 10 N: ± 15 C: ± 25 D: ± 50 E: ± 100 - : No Specified | T: 1W U: 1/2W V: 1/4W G: 2/5W | 0010: 1Ω 0100: 10Ω 1000: 100Ω 1001: 1KΩ 1004: 1MΩ R0R0: 0Ω R050: 0.05Ω R100: 0.1Ω 22R1: 22.1Ω | |

** Letter "R" is a decimal point.

※Packaging Code "S" & "M" only for 0204 size product, not include 0207 size product.

■ Soldering Condition (Ref. IPC/JEDEC J-STD-020 & J-STD-002)

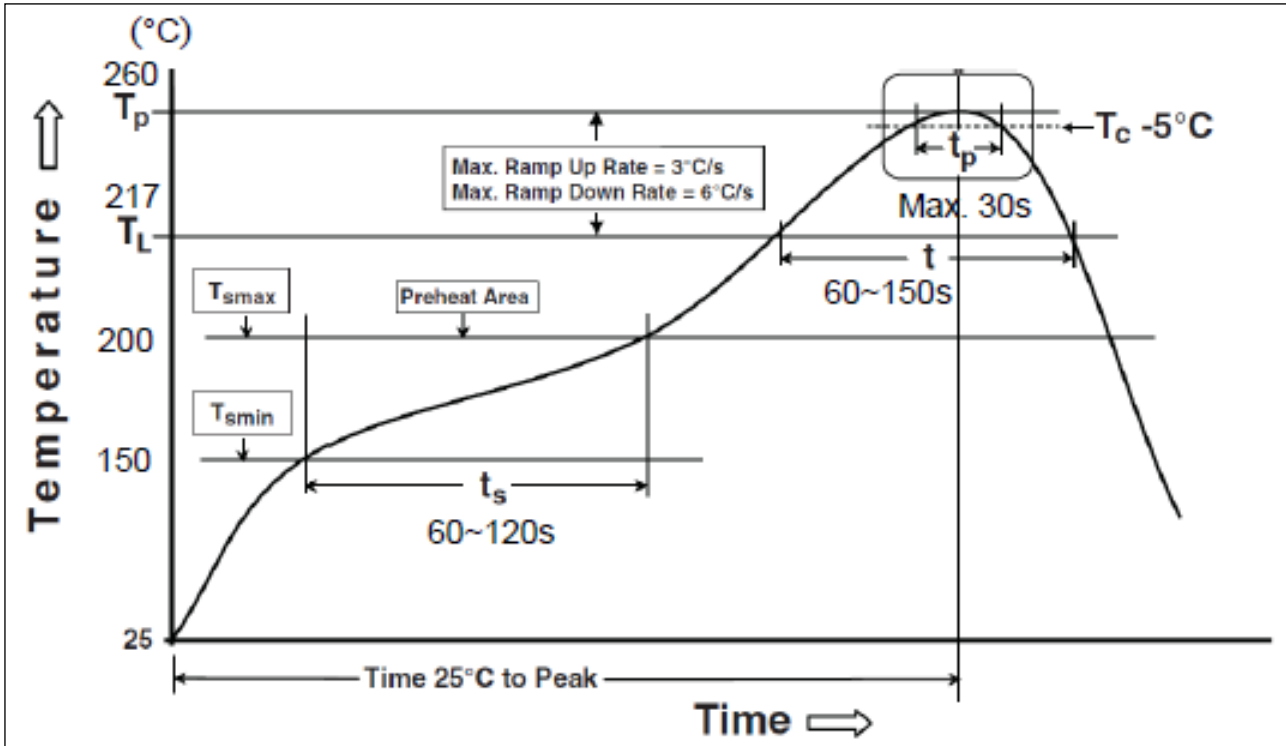

| Reflow Profiles | |
|--|------------------|
| Profile Feature | Pb-Free Assembly |
| Preheat | |
| Min. Temperature (T _{smin}) | 150 °C |
| Max Temperature (T _{smax}) | 200 °C |
| Preheating time (t _s) from (T _{smin} to T _{smax}) | 60-120 seconds |
| Ramp-up rate (T _L to T _p) | 3 °C/second max. |
| Liquidous temperature (T _L) | 217 °C |
| Time (t _L) maintained above T _L | 60-150 seconds |
| Min. Peak temperature (T _p min) | 235°C |
| Max. Peak temperature (T _p max) | 260°C |
| Time (t _p) within 5 °C of the specified classification temperature (T _c) | 30 seconds max. |
| Ramp-down rate (T _p to T _L) | 6 °C/second max. |
| Time 25 °C to peak temperature | 8 minutes max. |

Standard Electrical Specifications

| Item Type | Power Rating at 70°C | Operating Temp. Range | Max. Operating Voltage | Max. Overload Voltage | Resistance Range | | | | | TCR (PPM/°C) |
|-----------|----------------------|-----------------------|------------------------|-----------------------|------------------|-----------|-----------|-----|------|--------------|
| | | | | | ±0.1% | ±0.25% | ±0.5% | ±1% | ±5% | |
| 0204 | 1/4W | -55 ~ +125°C | 200V | 400V | 10Ω-332KΩ | | - | | | ±5 |
| | | | | | 10Ω-20KΩ | | | | | ±10 |
| | | | | | 10Ω-300KΩ | | | | | ±15 |
| | | -55 ~ +155°C | 200V | 400V | 10Ω-1MΩ | 10Ω-3.4MΩ | 1Ω-4.7MΩ | | ±25 | |
| | | | | | 10Ω-1MΩ | 1Ω-3.4MΩ | 0.2Ω-10MΩ | | ±50 | |
| | | | | | - | | 0.1Ω-10MΩ | | ±100 | |
| Jumper:2A | - | | 0Ω(<15mΩ) | | - | | | | | |
| 0207 | 1/2W | -55 ~ +125°C | 300V | 600V | 10Ω-332KΩ | | - | | | ±5 |
| | | | | | 10Ω-20KΩ | | | | | ±10 |
| | | | | | 10Ω-300KΩ | | | | | ±15 |
| | | -55 ~ +155°C | 300V | 600V | 10Ω-1MΩ | 10Ω-3.4MΩ | 1Ω-4.7MΩ | | ±25 | |
| | | | | | 10Ω-1MΩ | 1Ω-3.4MΩ | 0.2Ω-10MΩ | | ±50 | |
| | | | | | - | | 0.1Ω-10MΩ | | ±100 | |
| Jumper:4A | - | | 0Ω(<15mΩ) | | - | | | | | |

High Power Rating Electrical Specifications

| Item Type | Power Rating at 70°C | Operating Temp. Range | Max. Operating Voltage | Max. Overload Voltage | Resistance Range | | | | | TCR (PPM/°C) |
|-----------|----------------------|-----------------------|------------------------|-----------------------|------------------|-----------|-----------|-----|------|--------------|
| | | | | | ±0.1% | ±0.25% | ±0.5% | ±1% | ±5% | |
| 0204 | 2/5W | -55 ~ +125°C | 200V | 400V | 10Ω-332KΩ | | - | | | ±5 |
| | | | | | 10Ω-20KΩ | | | | | ±10 |
| | | | | | 10Ω-300KΩ | | | | | ±15 |
| | | -55 ~ +155°C | 200V | 400V | 10Ω-1MΩ | 10Ω-3.4MΩ | 1Ω-4.7MΩ | | ±25 | |
| | | | | | 10Ω-1MΩ | 1Ω-3.4MΩ | 0.2Ω-10MΩ | | ±50 | |
| | | | | | - | | 0.1Ω-10MΩ | | ±100 | |
| 0207 | 1W | -55 ~ +125°C | 300V | 600V | 10Ω-332KΩ | | - | | | ±5 |
| | | | | | 10Ω-20KΩ | | | | | ±10 |
| | | | | | 10Ω-300KΩ | | | | | ±15 |
| | | -55 ~ +155°C | 300V | 600V | 10Ω-1MΩ | 10Ω-3.4MΩ | 1Ω-4.7MΩ | | ±25 | |
| | | | | | 10Ω-1MΩ | 1Ω-3.4MΩ | 0.2Ω-10MΩ | | ±50 | |
| | | | | | - | | 0.1Ω-10MΩ | | ±100 | |

Operating Voltage= $\sqrt{P \cdot R}$ or Max. Operating Voltage listed above, whichever is lower.

Overload Voltage= $2.5 \cdot \sqrt{P \cdot R}$ or Max. Overload Voltage listed above, whichever is lower.

■ Viking is capable of manufacturing the optional spec based on customer's requirement.

Environmental Characteristics

| Item | Requirement | | Test Method |
|--|--|--------|--|
| | 5% and Below | Jumper | |
| Temperature Coefficient of Resistance (T.C.R.) | As Spec | | JIS-C-5201-1 4.8 IEC-60115-1 4.8 At 25°C/-55°C and 25°C/+125°C, 25°C is the reference temperature 5ppm: At 25°C/-10°C and 25°C/+85°C, 25°C is the reference temperature |
| Short Time Overload | $\pm(0.15\%+0.05\Omega)$ 5ppm: $\pm(0.05\%+0.01\Omega)$ | <15mΩ | JIS-C-5201-1 4.13 IEC-60115-1 4.13 RCWV*2.5 or Max. Overload Voltage whichever is lower for 5 seconds |
| Insulation Resistance | ≥10G | | JIS-C-5201-1 4.6 IEC-60115-1 4.6 Max. Overload Voltage for 1 minute |

Metal Film Precision Resistor

| | | | |
|------------------------------|--|---------------|---|
| Endurance | $\pm(0.5\%+0.05\Omega)$ 5ppm: $\pm(0.25\%+0.01\Omega)$ | <15m Ω | JIS-C-5201-1 4.25 IEC-60115-1 4.25.1 70 \pm 2 $^{\circ}$ C, RCWV for 1000 hrs with 1.5 hrs "ON" and 0.5 hr "OFF" |
| Damp Heat with Load | $\pm(1.0\%+0.05\Omega)$ 5ppm: $\pm(0.25\%+0.01\Omega)$ | <15m Ω | JIS-C-5201-1 4.24 IEC-60115-1 4.24 40 \pm 2 $^{\circ}$ C, 90~95% R.H., RCWV for 1000 hrs with 1.5 hrs "ON" and 0.5 hr "OFF" |
| Dry Heat | $\pm(1.0\%+0.05\Omega)$ 5ppm: $\pm(0.25\%+0.01\Omega)$ | <15m Ω | JIS-C-5201-1 4.23 IEC-60115-1 4.23.2 at +125 $^{\circ}$ C/+155 $^{\circ}$ C for 1000 hrs |
| Bending Strength | $\pm(0.5\%+0.05\Omega)$ 5ppm: $\pm(0.1\%+0.01\Omega)$ | <15m Ω | JIS-C-5201-1 4.33 IEC-60115-1 4.33 Bending once for 5 seconds with 2mm |
| Solderability | 95% min. coverage | | JIS-C-5201-1 4.17 IEC-60115-1 4.17 245 \pm 5 $^{\circ}$ C for 3 seconds |
| Resistance to Soldering Heat | $\pm(0.5\%+0.05\Omega)$ 5ppm: $\pm(0.05\%+0.01\Omega)$ | <15m Ω | JIS-C-5201-1 4.18 IEC-60115-1 4.18 260 \pm 5 $^{\circ}$ C for 10 seconds |
| Voltage Proof | No breakdown or flashover | | JIS-C-5201-1 4.7 IEC-60115-1 4.7 1.42 times Max. Operating Voltage for 1 minute |
| Leaching | Individual leaching area \leq 5% Total leaching area \leq 10% | | JIS-C-5201-1 4.18 IEC-60068-2-58 8.2.1 260 \pm 5 $^{\circ}$ C for 30 seconds |
| Rapid Change of Temperature | $\pm(0.5\%+0.05\Omega)$ 5ppm: $\pm(0.2\%+0.01\Omega)$ | <15m Ω | JIS-C-5201-1 4.19 IEC-60115-1 4.19 -55 $^{\circ}$ C to +125 $^{\circ}$ C/+155 $^{\circ}$ C, 5 cycles |

RCWV(Rated Continuous Working Voltage)= $\sqrt{P \cdot R}$ or Max. Operating Voltage whichever is lower.

■ **Storage Temperature: 15~28 $^{\circ}$ C; Humidity < 80%RH**

■ **Shelf Life: 2 years from production date.**

Metal Film Precision Resistor

■ Packaging

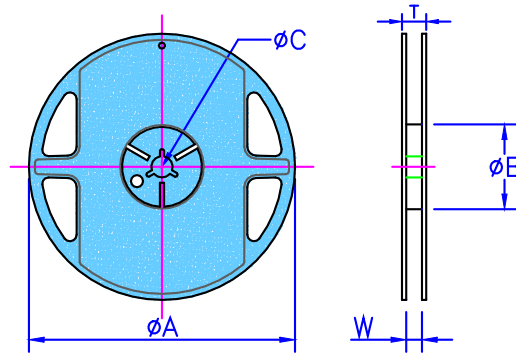

Packaging Quantity & Reel Specifications

| Type | Reel Diameter | ΦA (mm) | ΦB (mm) | ΦC (mm) | W (mm) | T (mm) | Emboss Plastic Tape (EA) |
|---------|---------------|---------------|---------------|---------------|----------|----------|--------------------------|
| CSR0204 | 7 inch | 178.5±1.5 | 60.0+1.0 | 13.0±0.2 | 9.0±0.5 | 12.5±0.5 | 3,000 |
| | 13 inch | 330±1.0 | 100±0.5 | 13.0±0.2 | 9.5±0.5 | 13.5±0.5 | 10,000 |
| CSR0207 | 7 inch | 178.5±1.5 | 60.0+1.0 | 13.0±0.5 | 13.0±0.5 | 15.5±0.5 | 2,000 |
| | 13 inch | 330±1.0 | 99±0.5 | 13.5±0.5 | 13.4±1 | 17.8±1 | 6,000 |

Emboss Plastic Tape Specifications

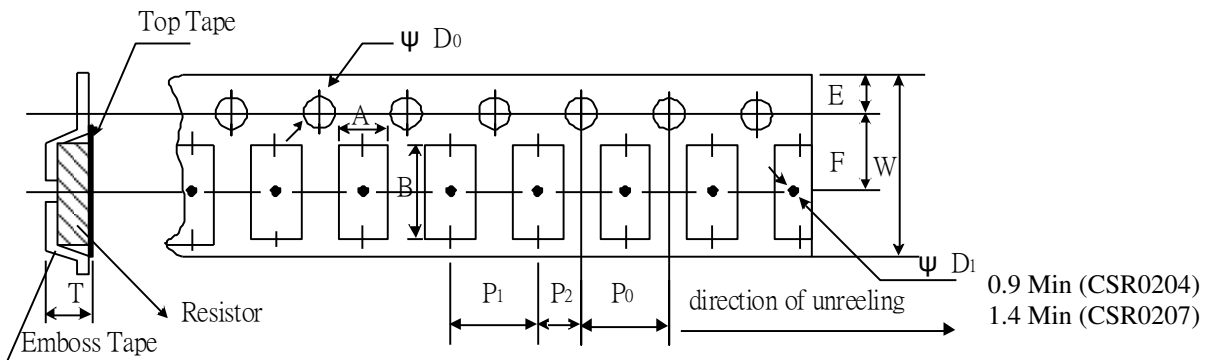

| Type | A (mm) | B (mm) | W (mm) | E (mm) | F (mm) | P_0 (mm) | P_1 (mm) | P_2 (mm) | ΦD_0 (mm) | T (mm) |
|---------|-----------|-----------|-----------|-----------|-----------|------------|------------|------------|-----------------|-----------|
| CSR0204 | 1.55±0.20 | 3.65±0.20 | 8.0±0.10 | 1.75±0.10 | 3.50±0.05 | 4.00±0.10 | 4.00±0.10 | 2.00±0.05 | 1.50+0.10 | 1.80±0.10 |
| CSR0207 | 2.40±0.10 | 6.15±0.10 | 12.0±0.10 | 1.75±0.10 | 5.50±0.05 | 4.00±0.10 | 4.00±0.10 | 2.00±0.05 | 1.50+0.10 | 2.70±0.10 |

■ Recommend Land Pattern

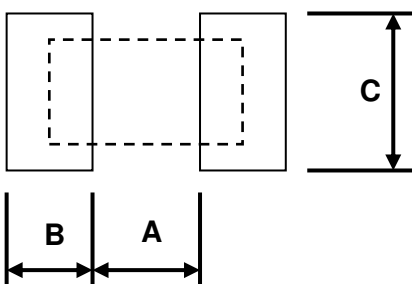

| Type | A (mm) | B (mm) | C (mm) |
|---------|--------|--------|--------|
| CSR0204 | 1.6 | 1.2 | 1.6 |
| CSR0207 | 3.0 | 1.7 | 2.4 |

■ Pulse withstanding capacity

The single impulse graph is the result of the impulse of rectangular shape applied. The limit of acceptance was a shift in resistance of less than 1% from the initial value. The power applied was subject to the restrictions of the maximum permissible impulse voltage graph shown.

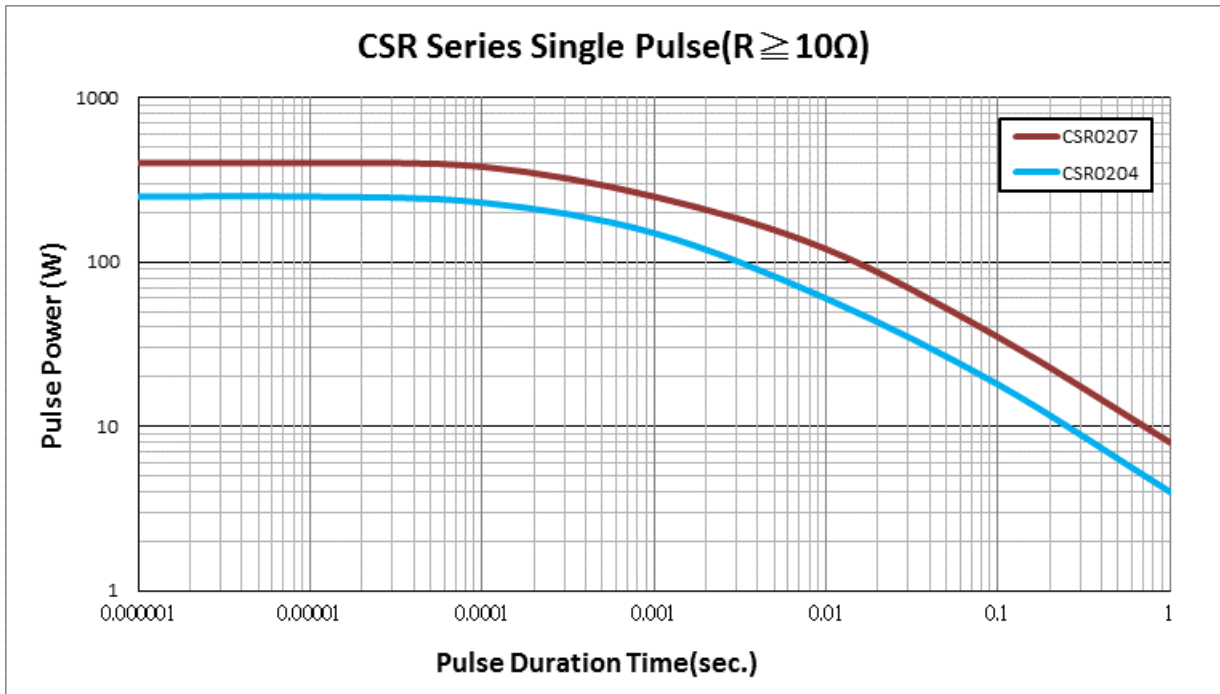
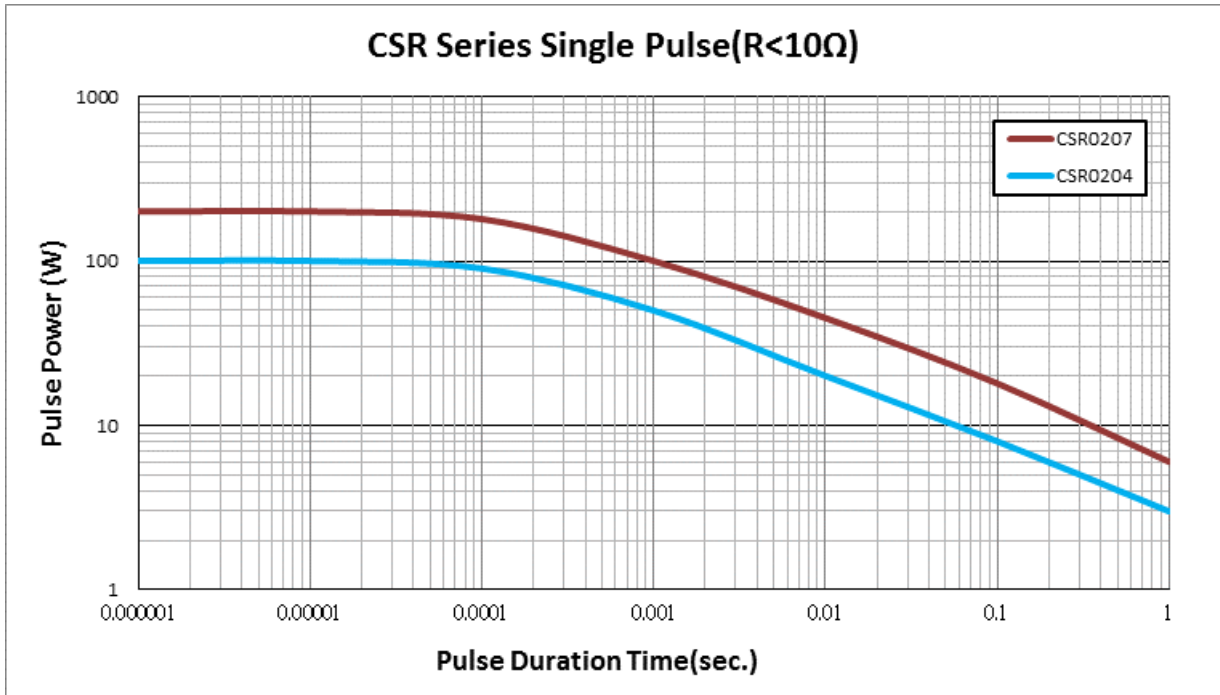

■ Continuous Pulse

The continuous load graph was obtained by applying repetitive rectangular pulses where the pulse period was adjusted so that the average power dissipated in the resistor was equal to its rated power at 70°C. Again the limit of acceptance was a shift in resistance of less than 1% from the initial value.

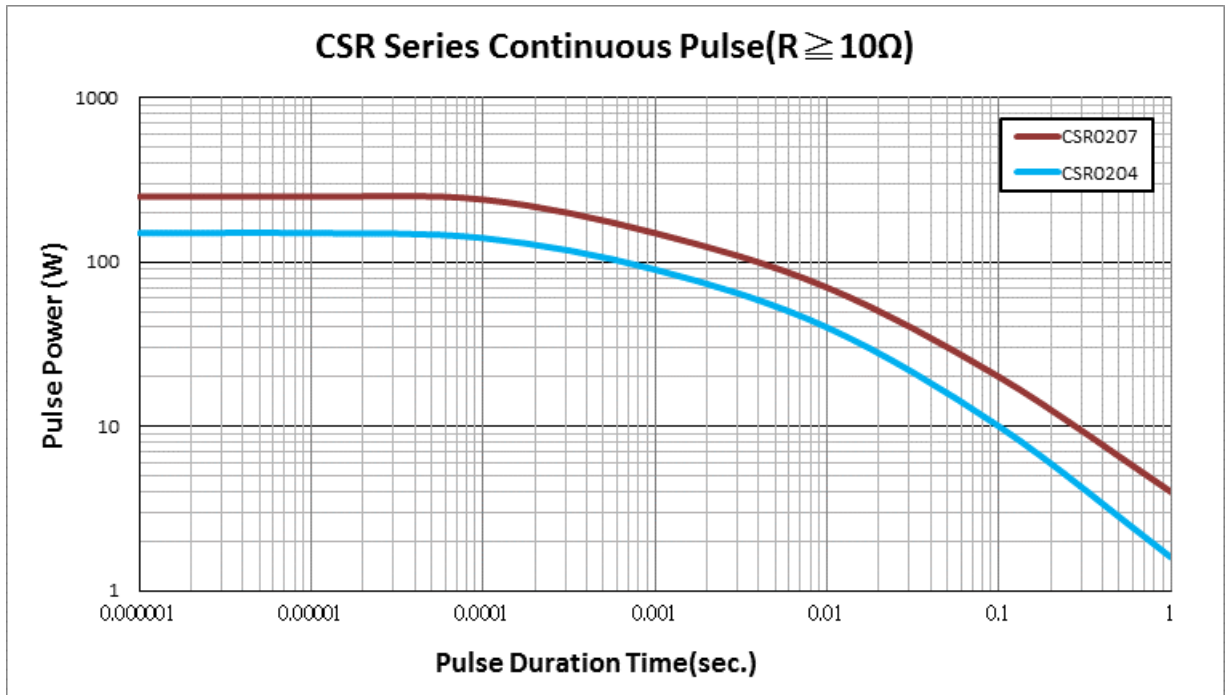
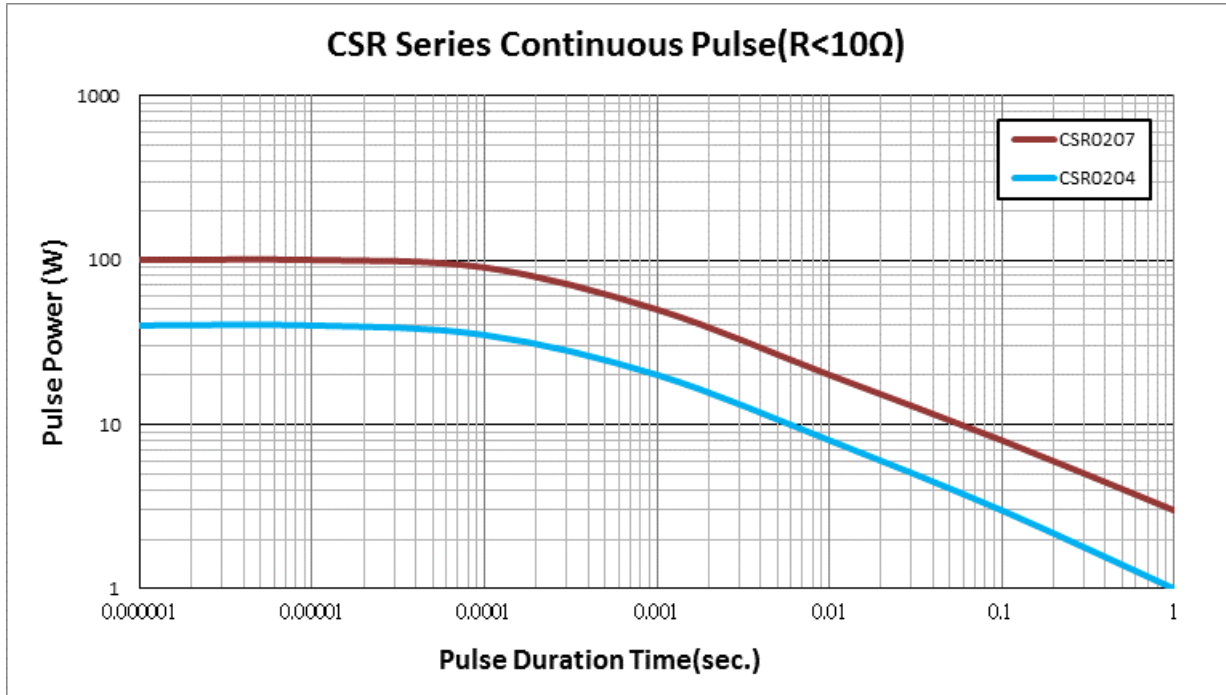

Frequency behavior

Resistors are designed to function according to ohmic laws. This is basically true of resistors for frequencies up to 100kHz. At higher frequencies, there is an additional contribution to the impedance by an ideal resistor switched in series with a coil and both switched parallel to a capacitor. The values of the capacitance and inductance are mainly determined by the dimensions of the terminations and the conductive path length.

The environment surrounding components has a large influence on the behavior of the component on the printed-circuit board.

**Frequency vs. Impedance
CSR Series(CSR0204)**

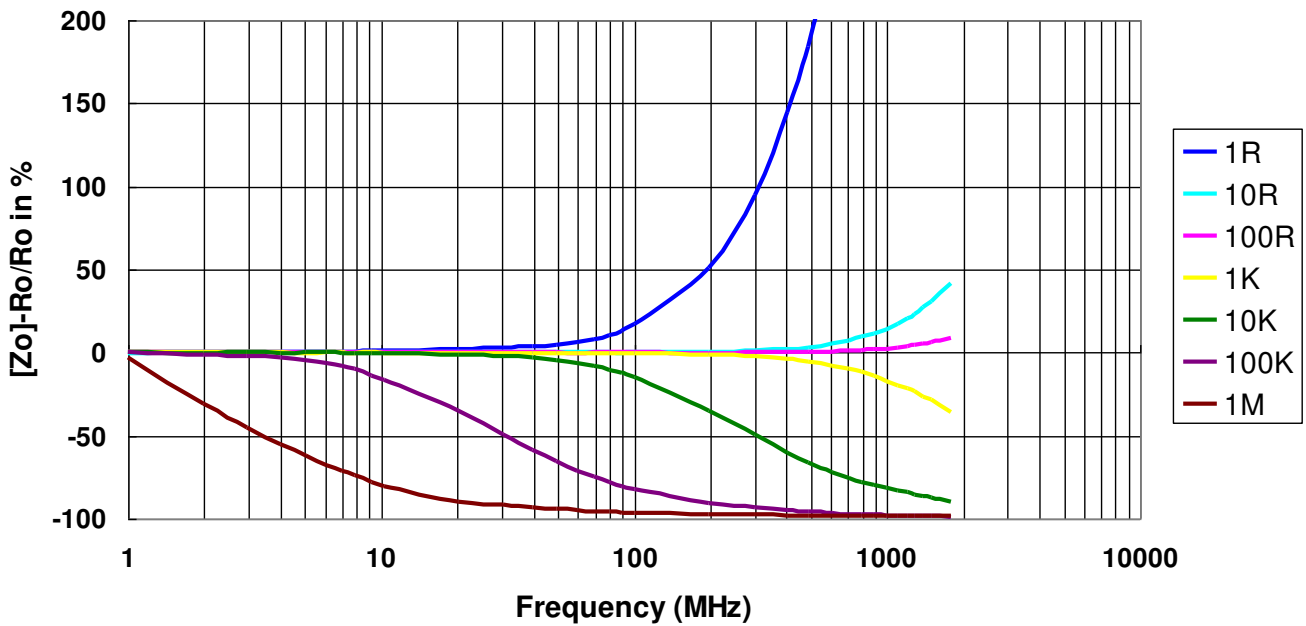

**Frequency vs. Phase Angle
CSR Series(CSR0204)**

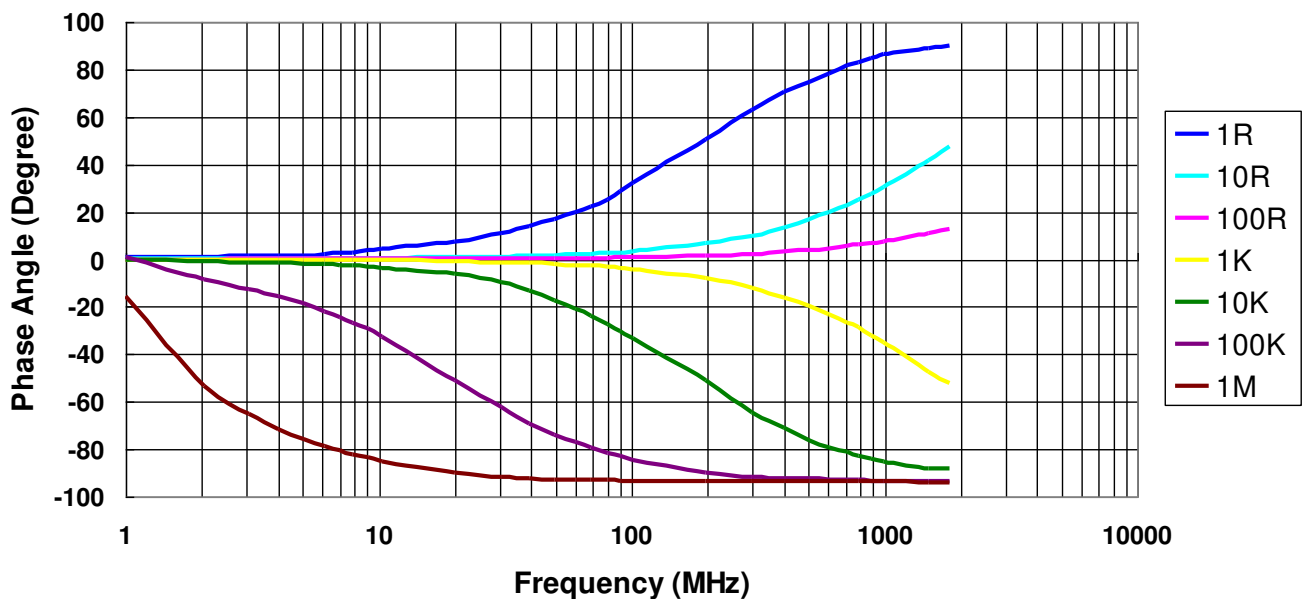

Frequency vs. Impedance CSR Series(CSR0207)

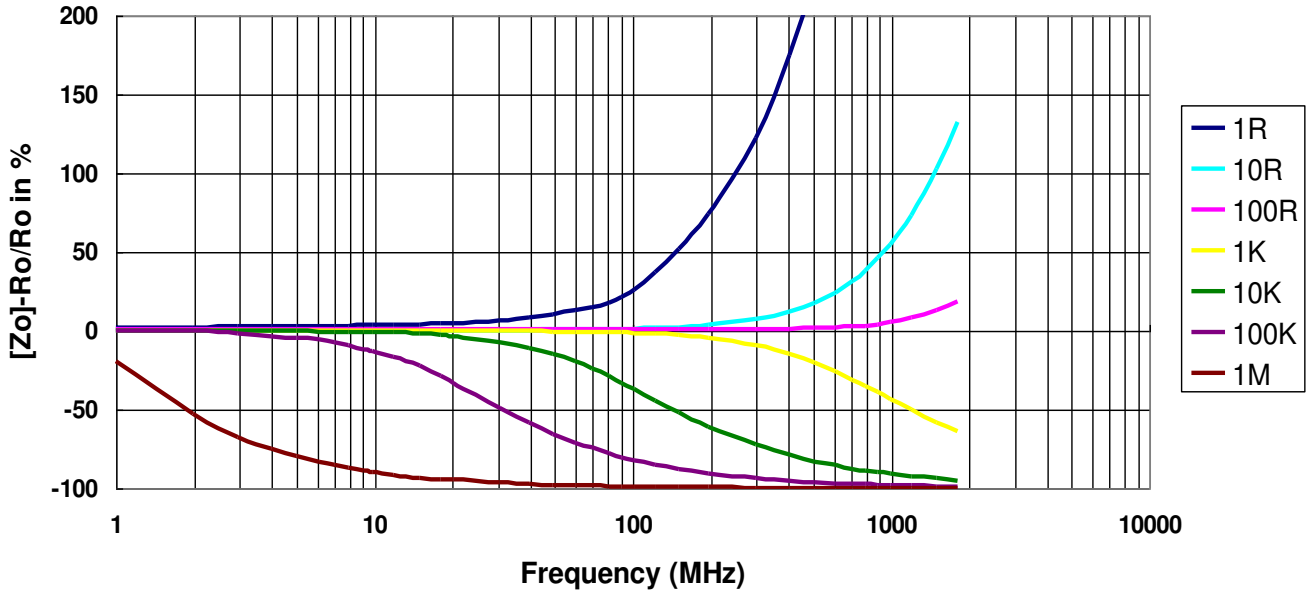

Frequency vs. Phase Angle CSR Series(CSR0207)

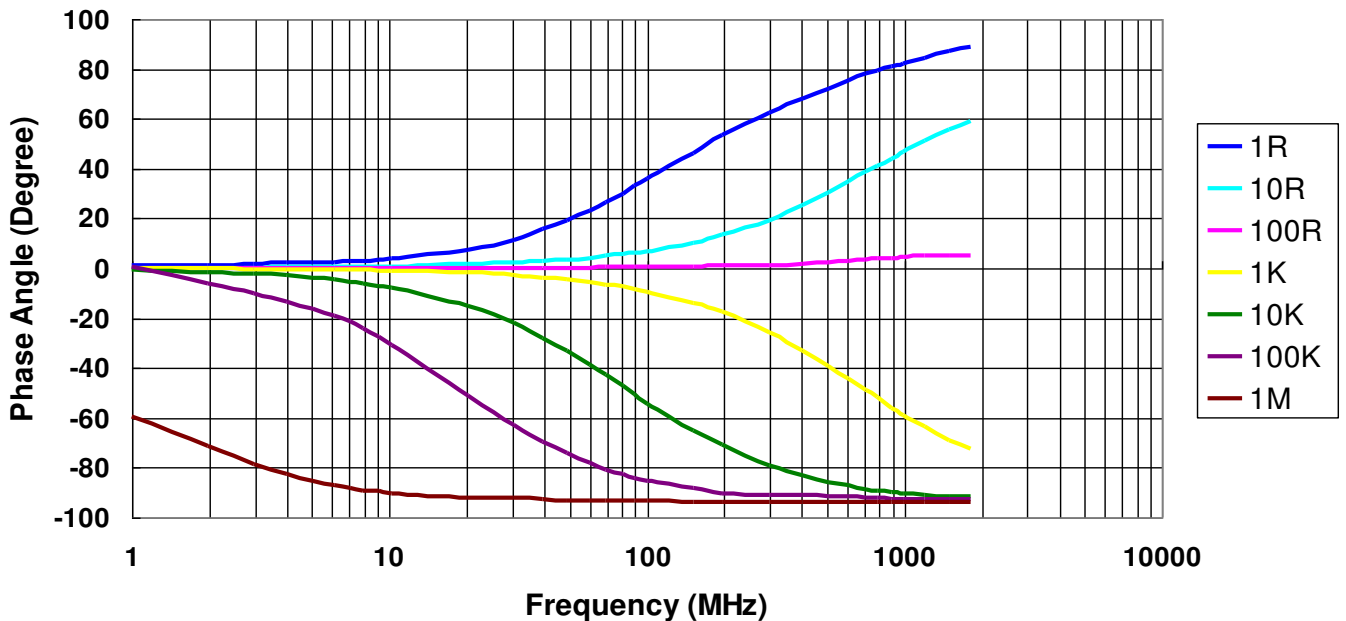

■ Lightning Surge

Resistors are tested in accordance with IEC 60 115-1 using both 1.2/50us and 10/700us pulse shapes. The limit of acceptance is a shift in resistance of less than 0.5% from the initial value.

1.2/50 μ s Lightning Surge

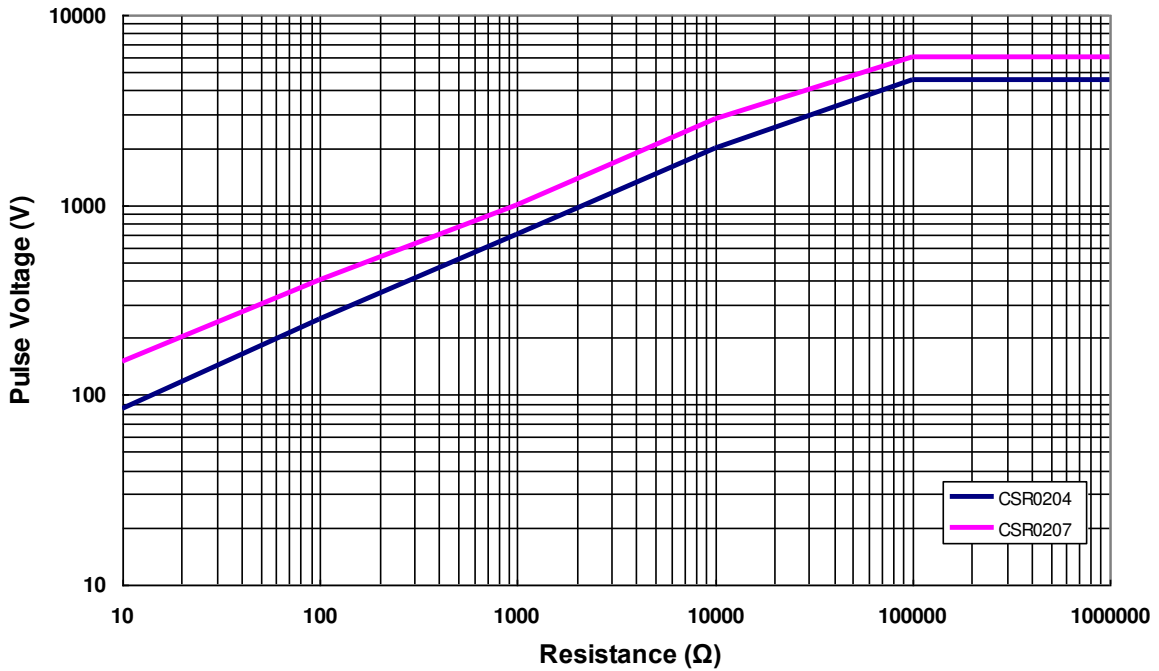

10/700 μ s Lightning Surge

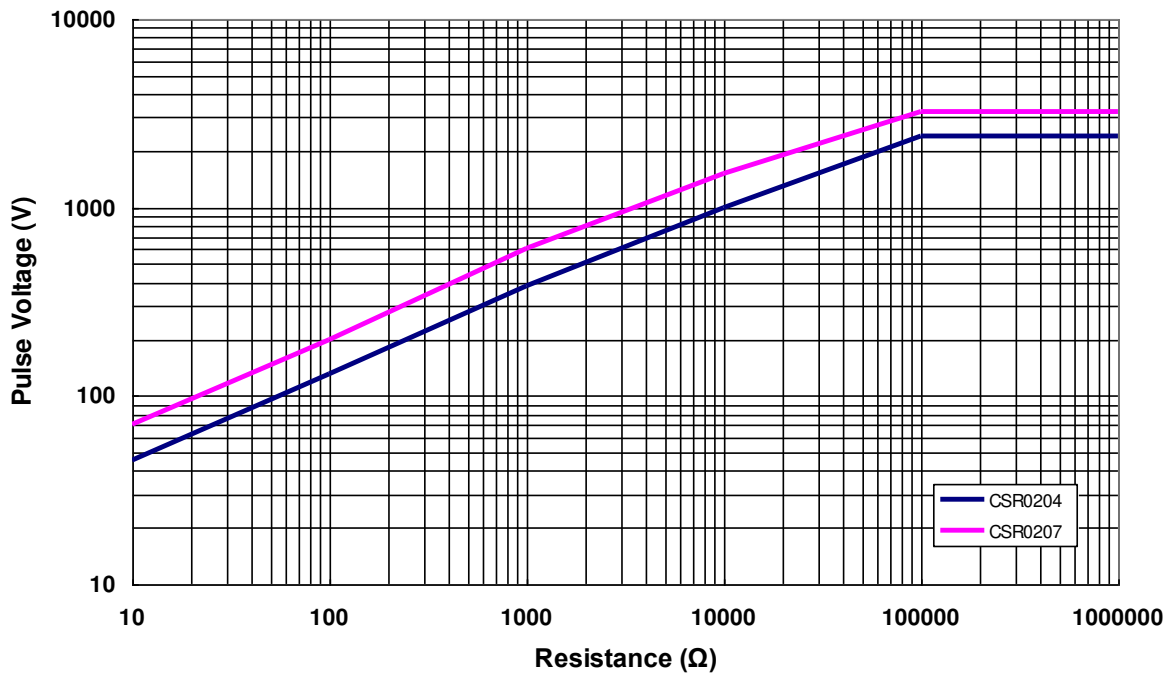

Metal Film Precision Resistor

■ Marking & Resistance Tolerance

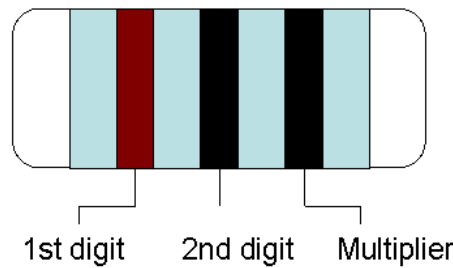

| | | | | | | | | | | | | | | | | | | | | | | | | | |
|-----|------|-----|-----|-----|-----|-----|-----|-----|-----|-----|-----|-----|-----|-----|-----|-----|-----|-----|-----|-----|-----|-----|-----|-----|-----|
| ±5% | E-24 | 1.0 | 1.1 | 1.2 | 1.3 | 1.5 | 1.6 | 1.8 | 2.0 | 2.2 | 2.4 | 2.7 | 3.0 | 3.3 | 3.6 | 3.9 | 4.3 | 4.7 | 5.1 | 5.6 | 6.2 | 6.8 | 7.5 | 8.2 | 9.1 |
|-----|------|-----|-----|-----|-----|-----|-----|-----|-----|-----|-----|-----|-----|-----|-----|-----|-----|-----|-----|-----|-----|-----|-----|-----|-----|

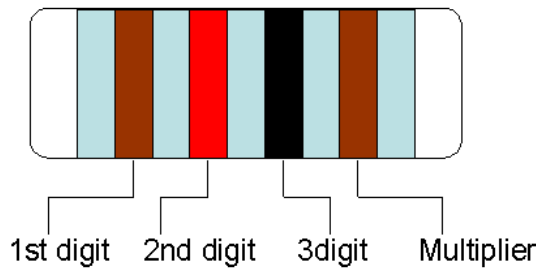

| | | | | | | | | | | | | | | | | | | | | | | | | | |
|-------|-------|------|------|------|------|------|------|------|------|------|------|------|------|------|------|------|------|------|------|------|------|------|------|------|------|
| ±1% | E-96 | 1.00 | 1.02 | 1.05 | 1.07 | 1.10 | 1.13 | 1.15 | 1.18 | 1.21 | 1.24 | 1.27 | 1.30 | 1.33 | 1.37 | 1.40 | 1.43 | 1.47 | 1.50 | 1.54 | 1.58 | 1.62 | 1.65 | 1.69 | 1.74 |
| | | 1.78 | 1.82 | 1.87 | 1.91 | 1.96 | 2.00 | 2.05 | 2.10 | 2.15 | 2.21 | 2.26 | 2.32 | 2.37 | 2.43 | 2.49 | 2.55 | 2.61 | 2.67 | 2.74 | 2.80 | 2.87 | 2.94 | 3.01 | 3.09 |
| | | 3.16 | 3.24 | 3.32 | 3.40 | 3.48 | 3.57 | 3.65 | 3.74 | 3.83 | 3.92 | 4.02 | 4.12 | 4.22 | 4.32 | 4.42 | 4.53 | 4.64 | 4.75 | 4.87 | 4.99 | 5.11 | 5.23 | 5.36 | 5.49 |
| | | 5.62 | 5.76 | 5.90 | 6.04 | 6.19 | 6.34 | 6.49 | 6.65 | 6.81 | 6.98 | 7.15 | 7.32 | 7.50 | 7.68 | 7.87 | 8.06 | 8.25 | 8.45 | 8.66 | 8.87 | 9.09 | 9.31 | 9.53 | 9.76 |
| ±0.5% | E-192 | 10.0 | 10.1 | 10.2 | 10.4 | 10.5 | 10.6 | 10.7 | 10.9 | 11.0 | 11.1 | 11.3 | 11.4 | 11.5 | 11.7 | 11.8 | 12.0 | 12.1 | 12.3 | 12.4 | 12.6 | 12.7 | 12.9 | 13.0 | 13.2 |
| | | 13.3 | 13.5 | 13.7 | 13.8 | 14.0 | 14.2 | 14.3 | 14.5 | 14.7 | 14.9 | 15.0 | 15.2 | 15.4 | 15.6 | 15.8 | 16.0 | 16.2 | 16.4 | 16.5 | 16.7 | 16.9 | 17.2 | 17.4 | 17.6 |
| | | 17.8 | 18.0 | 18.2 | 18.4 | 18.7 | 18.9 | 19.1 | 19.3 | 19.6 | 19.8 | 20.0 | 20.3 | 20.5 | 20.8 | 21.0 | 21.3 | 21.5 | 21.8 | 22.1 | 22.3 | 22.6 | 22.9 | 23.2 | 23.4 |
| | | 23.7 | 24.0 | 24.3 | 24.6 | 24.9 | 25.2 | 25.5 | 25.8 | 26.1 | 26.4 | 26.7 | 27.1 | 27.4 | 27.7 | 28.0 | 28.4 | 28.7 | 29.1 | 29.4 | 29.8 | 30.1 | 30.5 | 30.9 | 31.2 |
| | | 31.6 | 32.0 | 32.4 | 32.8 | 33.2 | 33.6 | 34.0 | 34.4 | 34.8 | 35.2 | 35.7 | 36.1 | 36.5 | 37.0 | 37.4 | 37.9 | 38.3 | 38.8 | 39.2 | 39.7 | 40.2 | 40.7 | 41.2 | 41.7 |
| | | 42.2 | 42.7 | 43.2 | 43.7 | 44.2 | 44.8 | 45.3 | 45.9 | 46.4 | 47.0 | 47.5 | 48.1 | 48.7 | 49.3 | 49.9 | 50.5 | 51.1 | 51.7 | 52.3 | 53.0 | 53.6 | 54.2 | 54.9 | 55.6 |
| | | 56.2 | 56.9 | 57.6 | 58.3 | 59.0 | 59.7 | 60.4 | 61.2 | 61.9 | 62.6 | 63.4 | 64.2 | 64.9 | 65.7 | 66.5 | 67.3 | 68.1 | 69.0 | 69.8 | 70.6 | 71.5 | 72.3 | 73.2 | 74.1 |
| | | 75.0 | 75.9 | 76.8 | 77.7 | 78.7 | 79.6 | 80.6 | 81.6 | 82.5 | 83.5 | 84.5 | 85.6 | 86.6 | 87.6 | 88.7 | 89.8 | 90.9 | 92.0 | 93.1 | 94.2 | 95.3 | 96.5 | 97.6 | 98.8 |

| Color | Digit | Multiplier |
|--------|-------|------------------|
| Silver | - | 10 ⁻² |
| Gold | - | 10 ⁻¹ |
| Black | 0 | 10 ⁰ |
| Brown | 1 | 10 ¹ |
| Red | 2 | 10 ² |
| Orange | 3 | 10 ³ |
| Yellow | 4 | 10 ⁴ |
| Green | 5 | 10 ⁵ |
| Blue | 6 | 10 ⁶ |
| Violet | 7 | 10 ⁷ |
| Grey | 8 | 10 ⁸ |
| White | 9 | 10 ⁹ |

※Resistance more than two significant figures(<1R) or more than three significant figures(>1R) will not provide color code.

REVISION HISTORY

| REVISION | DATE | CHANGE NOTIFICATION | DESCRIPTION |
|------------|--------------|---------------------|---|
| Version B9 | Jun 03, 2014 | - | - Electrical Specifications updated - Environmental Characteristics updated |
| Version C | Feb 25, 2015 | - | - Max overload voltage updated - Increase the color code Description |
| Version C1 | Apr 30, 2015 | - | - Electrical Specifications updated (CSR0102) - Dimension "K" updated |
| Version C2 | Jul 07, 2015 | - | - Increase CSR0102 Characteristic Curve |
| Version C3 | Jul 15, 2016 | - | - Modify Storage Temperature - Remove CSR0102 specification |
| Version C4 | Jun 01, 2017 | - | - Electrical Specifications updated |
| Version C5 | Jan 12, 2018 | - | - Electrical Specifications updated - Increase L1 & Φ D1 Dimension - Environmental Characteristics updated |
| Version C6 | May 20, 2019 | - | - Modify TCR Test description |
| Version C7 | Mar 31, 2020 | - | - Increase 5ppm specification range |
| Version C8 | Jun 30, 2020 | - | - Increase 5ppm specification range |
| Version C9 | Mar 10, 2021 | - | - Modify Soldering Condition (IPC/JEDEC J-STD-020) - Electrical Specifications updated |
| Version D | Sep 3, 2021 | - | - Modify Pulse Curve |
| Version D1 | Sep 28, 2021 | - | - Add in Shelf Life: 2 years from production date. |
| Version D2 | Jan 05, 2022 | - | - Newly added antistatic tape packaging for packaging methods. |
| Version D3 | Feb 15, 2022 | - | - Derating Curve changes the temperature range. |
| Version D4 | Jun 15, 2022 | - | - Modify Soldering Condition |