

High Isolation Power Transformer

Shaped Core Platform SMD



- Flyback Converter Transformer
- Designed for Broadcom ACPL-32JT and ACPL-302J IGBT Gate Driver
- Compact and cost effective industrial design
- PH9363NL: Basic insulation, 2.8mm creepage
- PH9496NL: Basic insulation, 6.2mm creepage
- PH0416NL: Reinforced insulation, 8.3mm creepage

Electrical Specifications @ 25°C - Operating Temperature -40°C to +125°C

Part Number	Inductance (Pri) ($\mu\text{H} \pm 10\%$)	Primary Current (A MAX)	Inductance (Sec) ($\mu\text{H} \pm 10\%$)	DCR (Sec) (Ω MAX)	Leakage Inductance (Pri) (μH Max)	Turns Ratio	Isolated Voltage (Vrms)
PH9363NL	60	1.0	240	0.60	3.0	1:2	2500 / 1 minute
PH9496NL	52	1.7	332	0.22	1.2	1:2.53	2500 / 1 minute
PH0416NL	43	1.0	172	1.2	2	1:2	5000 / 1 minute

Notes:

- These transformers are approved by Broadcom to deliver a isolated 18V IGBT drive voltage from a 8V-18V source.
- Optional Tape & Reel packing can be ordered by adding a "T" suffix to the part number.
- Other turns ratios and isolation levels available on request.
- The rated primary current is based on a peak flux density of 220mT.

Mechanical

Schematic

PH9363NL

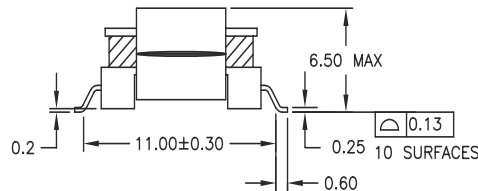
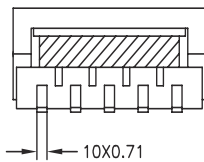
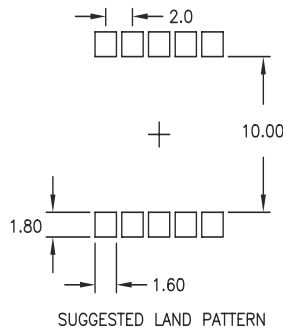
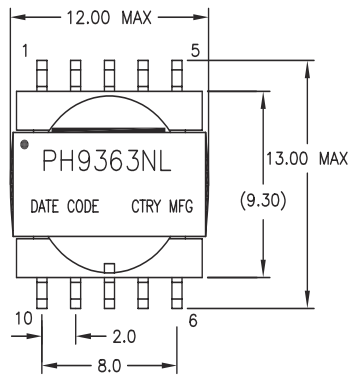

FINAL OUTLINE

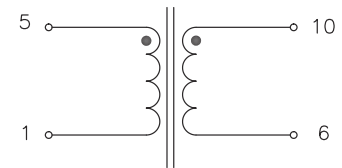

Weight1.4grams
Tape & Reel500/reel
Tray100/tray

Dimensions: mm

Unless otherwise specified,
all tolerances are±0.25

High Isolation Power Transformer

Shaped Core Platform SMD



PH9496NL

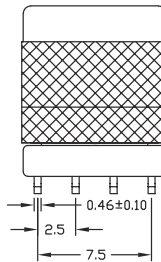
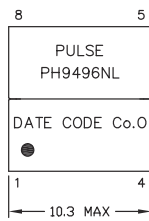

Mechanical

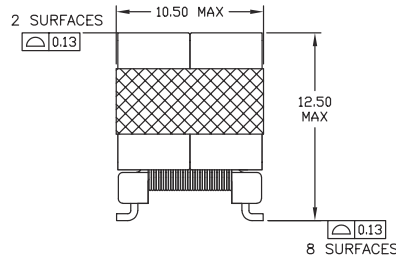
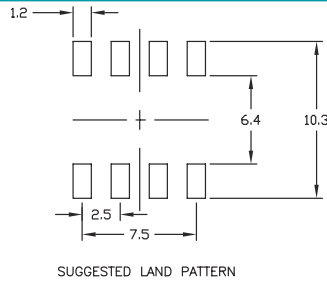

Schematic

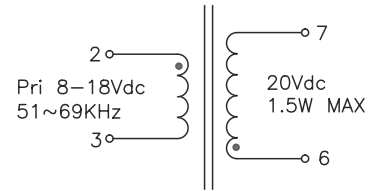

Weight2.6grams
Tape & Reel175/reel
Tray90/tray
Dimensions: mm

Unless otherwise specified,
all tolerances are±0.25

PH0416NL

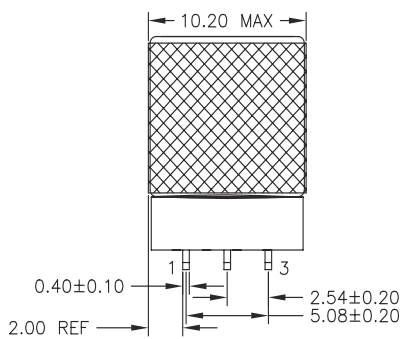

Mechanical

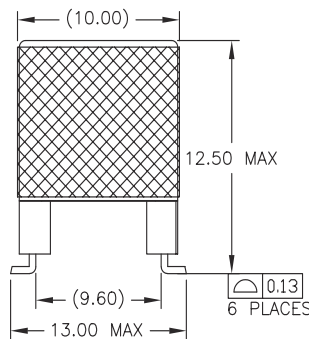
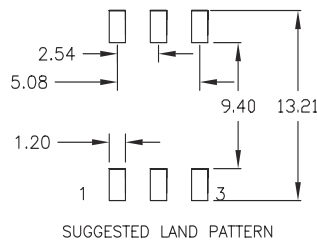

Schematic

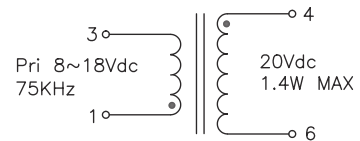

Weight2.6grams
Tape & Reel150/reel
Tray80/tray
Dimensions: mm

Unless otherwise specified,
all tolerances are±0.25

For More Information

Pulse Worldwide Headquarters

15255 Innovation Drive Ste 100
San Diego, CA 92128
U.S.A.

Pulse Europe

Pulse Electronics GmbH
Am Rottland 12
58540 Meinerzhagen
Germany

Pulse China Headquarters

Pulse Electronics (ShenZhen) CO., LTD
D708, Shenzhen Academy of
Aerospace Technology,
The 10th Keji South Road,
Nanshan District, Shenzhen,
P.R. China 518057

Pulse North China

Room 2704/2705
Super Ocean Finance Ctr.
2067 Yan An Road West
Shanghai 200336
China

Pulse South Asia

3 Fraser Street
0428 DUO Tower
Singapore 189352

Pulse North Asia

1F., No.111 Xiyuan Rd
Zhongli City
Taoyuan City 32057
Taiwan (R.O.C)

Tel: 858 674 8100
Fax: 858 674 8262

Tel: 49 2354 777 100
Fax: 49 2354 777 168

Tel: 86 755 33966678
Fax: 86 755 33966700

Tel: 86 21 62787060
Fax: 86 2162786973

Tel: 65 6287 8998
Fax: 65 6280 0080

Tel: 886 3 4356768
Fax: 886 3 4356820

Performance warranty of products offered on this data sheet is limited to the parameters specified. Data is subject to change without notice. Other brand and product names mentioned herein may be trademarks or registered trademarks of their respective owners. © Copyright, 2018. Pulse Electronics, Inc. All rights reserved.