

BUK7L11-34ARC

TrenchPLUS standard level FET

Rev. 04 — 16 December 2005

Product data sheet

1. Product profile

1.1 General description

N-channel enhancement mode field-effect power transistor in a plastic package using Philips General-Purpose Automotive (GPA) TrenchMOS technology.

1.2 Features

- ESD and clamping diodes
- 175 °C rated
- Q101 compliant
- Internal gate resistor

1.3 Applications

- Automotive systems
- Motors, lamps and solenoids
- General purpose power switching
- 12 V loads

1.4 Quick reference data

- $E_{DS(CL)S} \leq 465$ mJ
- $I_D \leq 75$ A
- $R_{DSon} = 8$ m Ω (typ)
- $P_{tot} \leq 172$ W

2. Pinning information

Table 1: Pinning

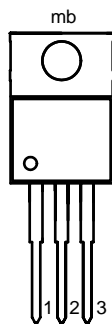
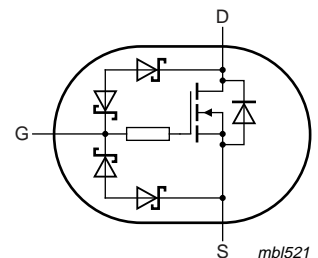
Pin	Description	Simplified outline	Symbol
1	gate (G)		
2	drain (D)		
3	source (S)		
mb	mounting base; connected to drain (D)		

SOT78C (TO-220)

PHILIPS

3. Ordering information

Table 2: Ordering information

Type number	Package		Version
	Name	Description	
BUK7L11-34ARC	3-lead TO-220	Plastic single-ended package; heatsink mounted; 1 mounting hole; 3 leads	SOT78C

4. Limiting values

Table 3: Limiting values

In accordance with the Absolute Maximum Rating System (IEC 60134).

Symbol	Parameter	Conditions	Min	Max	Unit
V_{DS}	drain-source voltage (DC)		[1] -	34	V
V_{DGR}	drain-gate voltage (DC)	$R_{GS} = 20 \text{ k}\Omega$	[1] -	34	V
V_{GS}	gate-source voltage (DC)		-	± 20	V
I_D	drain current (DC)	$T_{mb} = 25 \text{ }^\circ\text{C}$; $V_{GS} = 10 \text{ V}$; Figure 2 and 3	[2] [4] -	89	A
			[3] -	75	A
		$T_{mb} = 100 \text{ }^\circ\text{C}$; $V_{GS} = 10 \text{ V}$; Figure 2	-	63	A
I_{DM}	peak drain current	$T_{mb} = 25 \text{ }^\circ\text{C}$; pulsed; $t_p \leq 10 \text{ }\mu\text{s}$; Figure 3	-	358	A
P_{tot}	total power dissipation	$T_{mb} = 25 \text{ }^\circ\text{C}$; Figure 1	-	172	W
$I_{DG(CL)}$	drain-gate clamping current	$t_p = 5 \text{ ms}$; $\delta = 0.01$	-	50	mA
$I_{GS(CL)}$	gate-source clamping current	continuous	-	10	mA
		$t_p = 5 \text{ ms}$; $\delta = 0.01$	-	50	mA
T_{stg}	storage temperature		-55	+175	$^\circ\text{C}$
T_j	junction temperature		-55	+175	$^\circ\text{C}$
Source-drain diode					
I_{DR}	reverse drain current (DC)	$T_{mb} = 25 \text{ }^\circ\text{C}$	[2] [4] -	89	A
			[3] -	75	A
I_{DRM}	peak reverse drain current	$T_{mb} = 25 \text{ }^\circ\text{C}$; pulsed; $t_p \leq 10 \text{ }\mu\text{s}$	-	358	A
Avalanche ruggedness					
$E_{DS(CL)S}$	non-repetitive drain-source clamped energy	unclamped inductive load; $I_D = 60 \text{ A}$; $V_{DS} \leq 34 \text{ V}$; $V_{GS} = 10 \text{ V}$; starting at $T_j = 25 \text{ }^\circ\text{C}$	-	465	mJ
Electrostatic discharge					
V_{esd}	electrostatic discharge voltage; all pins	human body model; $C = 100 \text{ pF}$; $R = 1.5 \text{ k}\Omega$	-	8	kV
		human body model; $C = 250 \text{ pF}$; $R = 1.5 \text{ k}\Omega$	-	6	kV

[1] Voltage is limited by clamping.

[2] Current is limited by power dissipation chip rating.

[3] Continuous current is limited by package.

[4] Refer to document 9397 750 12572 for further information.

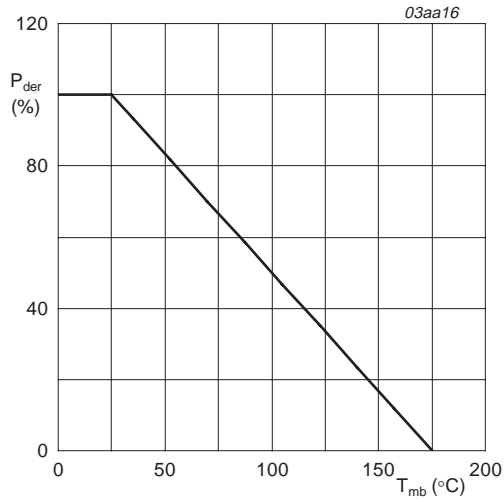

$$P_{der} = \frac{P_{tot}}{P_{tot(25^\circ\text{C})}} \times 100\%$$

Fig 1. Normalized total power dissipation as a function of mounting base temperature

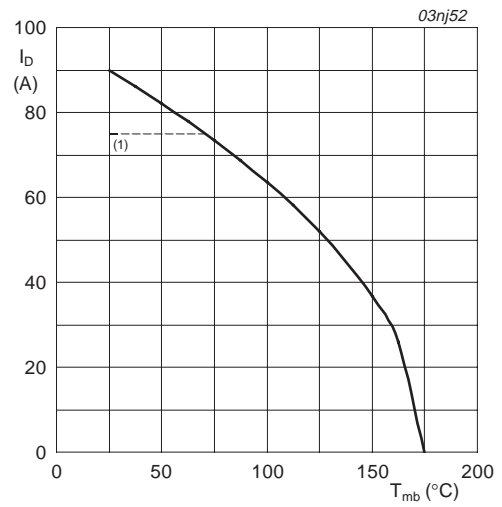

$V_{GS} \geq 10\text{ V}$

(1) Capped at 75 A due to package.

Fig 2. Continuous drain current as a function of mounting base temperature

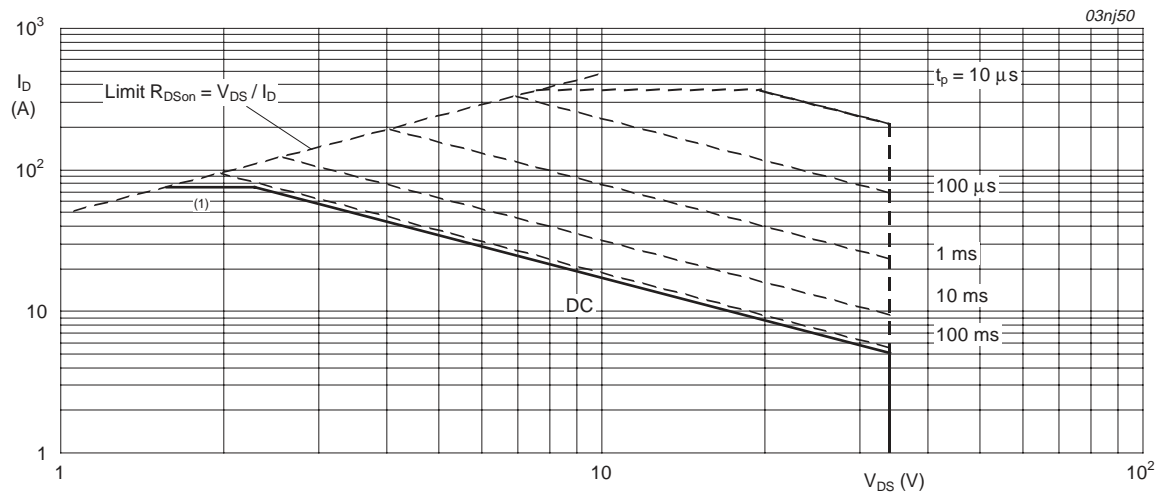

$T_{mb} = 25^\circ\text{C}$; I_{DM} is single pulse.

(1) Capped at 75 A due to package.

Fig 3. Safe operating area; continuous and peak drain currents as a function of drain-source voltage

5. Thermal characteristics

Table 4: Thermal characteristics

Symbol	Parameter	Conditions	Min	Typ	Max	Unit
$R_{th(j-mb)}$	thermal resistance from junction to mounting base		-	0.55	0.87	K/W
$R_{th(j-a)}$	thermal resistance from junction to ambient	vertical in free air	-	60	-	K/W

5.1 Transient thermal impedance

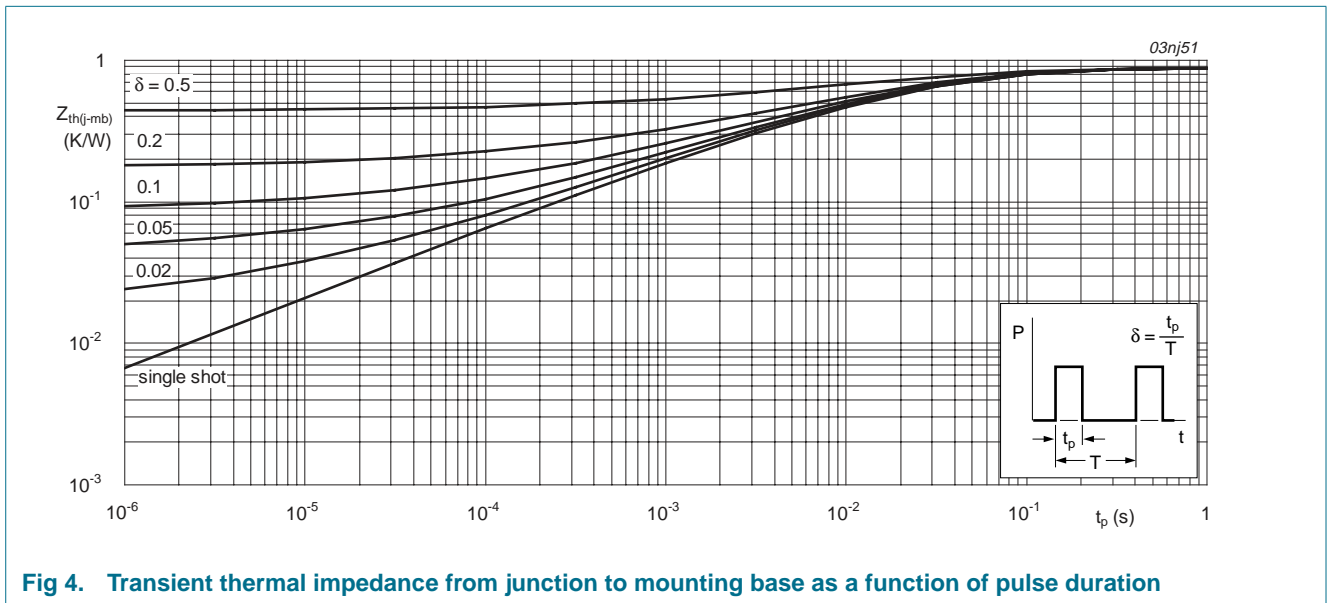

Fig 4. Transient thermal impedance from junction to mounting base as a function of pulse duration

6. Characteristics

Table 5: Characteristics
T_j = 25 °C unless otherwise specified.

Symbol	Parameter	Conditions	Min	Typ	Max	Unit
Static characteristics						
V _{(BR)DG}	drain-gate zener breakdown voltage	I _D = 2 mA; V _{GS} = 0 V				
		T _j = 25 °C	34	-	45	V
		T _j = -55 °C	34	-	45	V
V _{DSR(CL)}	drain-source clamping voltage (DC)	I _{GS(CL)} = -2 mA; I _D = 1 A; Figure 17 and 18	-	41	-	V
V _{GS(th)}	gate-source threshold voltage	I _D = 1 mA; V _{DS} = V _{GS} ; Figure 9 and 10				
		T _j = 25 °C	2.2	3	3.8	V
		T _j = 150 °C	1.5	-	-	V
		T _j = 175 °C	1.2	-	-	V
I _{DSS}	drain-source leakage current	V _{DS} = 16 V; V _{GS} = 0 V				
		T _j = 25 °C	-	0.1	2	μA
		T _j = 150 °C	-	3	50	μA
V _{(BR)GSS}	gate-source breakdown voltage	I _G = ±1 mA; -55 °C < T _j + 175 °C; Figure 18 and 19	20	22	-	V
		T _j = 175 °C	-	18	250	μA
		T _j = -55 °C	-	-	4.2	V
I _{GSS}	gate-source leakage current	V _{GS} = ±10 V; V _{DS} = 0 V				
		T _j = 25 °C	-	5	1000	nA
		T _j = 175 °C	-	-	50	μA
		V _{GS} = 16 V; V _{DS} = 0 V				
R _{DS(on)}	drain-source on-state resistance	V _{GS} = 10 V; I _D = 30 A; Figure 6 and 8				
		T _j = 25 °C	-	8	11	mΩ
		T _j = 175 °C	-	-	20.9	mΩ
R _G	internal gate resistor	V _{GS} = 16 V; I _D = 30 A	-	7	9.7	mΩ
			-	11	-	Ω
Dynamic characteristics						
Q _{g(tot)}	total gate charge	I _D = 25 A; V _{DD} = 27 V; V _{GS} = 10 V; Figure 14	-	53	-	nC
Q _{gs}	gate-source charge		-	11	-	nC
Q _{gd}	gate-drain (Miller) charge		-	20	-	nC
C _{iss}	input capacitance	V _{GS} = 0 V; V _{DS} = 25 V; f = 1 MHz; Figure 12	-	1880	2506	pF
C _{oss}	output capacitance		-	640	768	pF
C _{rss}	reverse transfer capacitance		-	400	548	pF
t _{d(on)}	turn-on delay time	V _{DS} = 30 V; R _L = 1.2 Ω;	-	20	-	ns
t _r	rise time	V _{GS} = 10 V; R _G = 10 Ω	-	92	-	ns
t _{d(off)}	turn-off delay time		-	127	-	ns
t _f	fall time		-	118	-	ns

Table 5: Characteristics ...continued
 $T_j = 25^\circ\text{C}$ unless otherwise specified.

Symbol	Parameter	Conditions	Min	Typ	Max	Unit
L_d	internal drain inductance	from drain lead 6 mm from package to center of die	-	4.5	-	nH
		from contact screw on mounting base to center of die	-	3.5	-	nH
L_s	internal source inductance	from source lead to source bonding pad	-	7.5	-	nH
Source-drain diode						
V_{SD}	source-drain (diode forward) voltage	$I_S = 25\text{ A}$; $V_{GS} = 0\text{ V}$; Figure 15	-	0.85	1.2	V
t_{rr}	reverse recovery time	$I_S = 20\text{ A}$; $di_S/dt = -100\text{ A}/\mu\text{s}$; $V_{GS} = 0\text{ V}$; $V_R = 30\text{ V}$	-	52	-	ns
Q_r	recovered charge	$V_{GS} = 0\text{ V}$; $V_R = 30\text{ V}$	-	28	-	nC

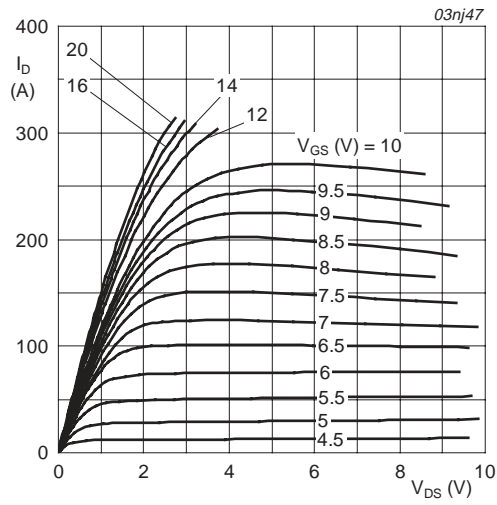

T_j = 25 °C

Fig 5. Output characteristics: drain current as a function of drain-source voltage; typical values

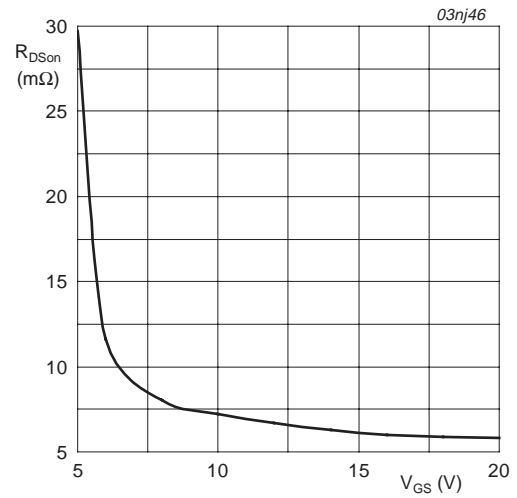

T_j = 25 °C; I_D = 30 A

Fig 6. Drain-source on-state resistance as a function of gate-source voltage; typical values

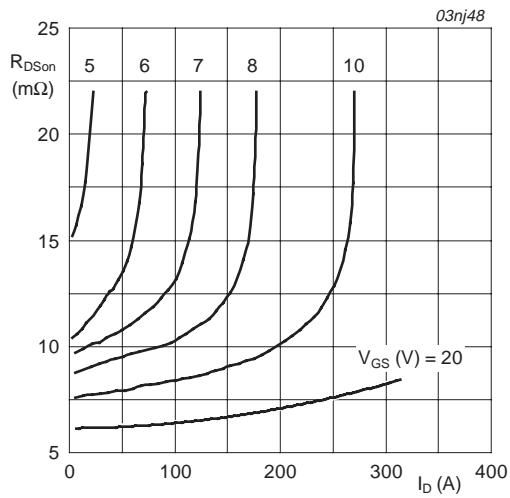

T_j = 25 °C

Fig 7. Drain-source on-state resistance as a function of drain current; typical values

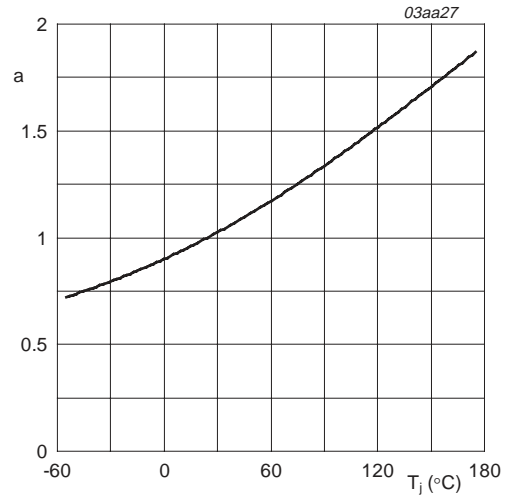

$$a = \frac{R_{DS(on)}}{R_{DS(on)(25\text{ }^{\circ}\text{C})}}$$

Fig 8. Normalized drain-source on-state resistance factor as a function of junction temperature

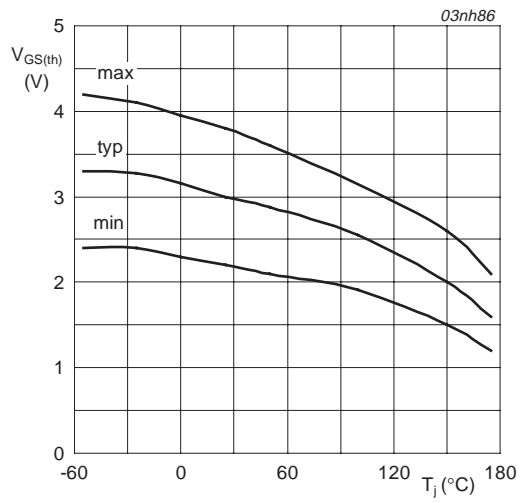

$I_D = 1 \text{ mA}; V_{DS} = V_{GS}$

Fig 9. Gate-source threshold voltage as a function of junction temperature

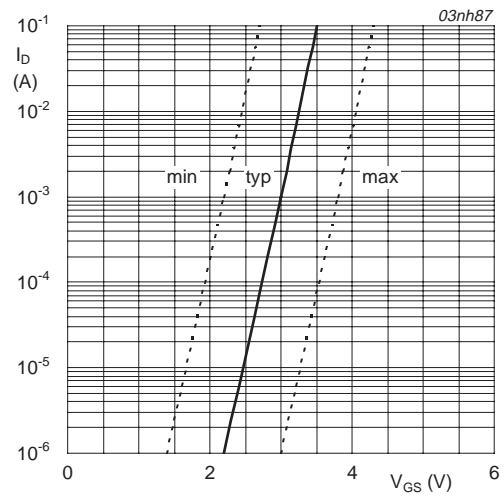

$T_j = 25 \text{ }^{\circ}C; V_{DS} = V_{GS}$

Fig 10. Sub-threshold drain current as a function of gate-source voltage

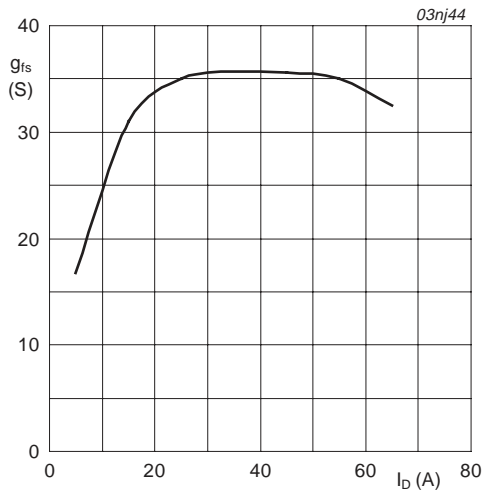

$T_j = 25 \text{ }^{\circ}C; V_{DS} = 25 \text{ V}$

Fig 11. Forward transconductance as a function of drain current; typical values

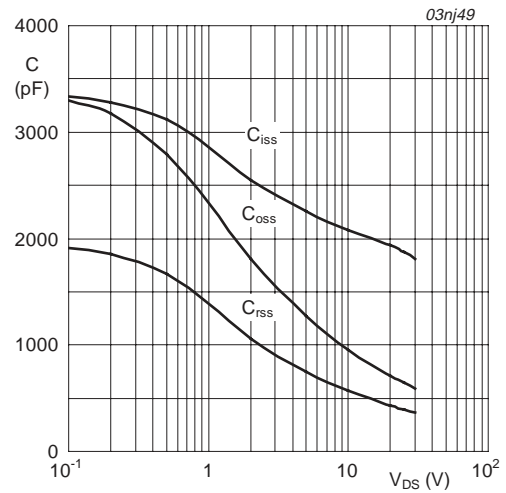

$V_{GS} = 0 \text{ V}; f = 1 \text{ MHz}$

Fig 12. Input, output and reverse transfer capacitances as a function of drain-source voltage; typical values

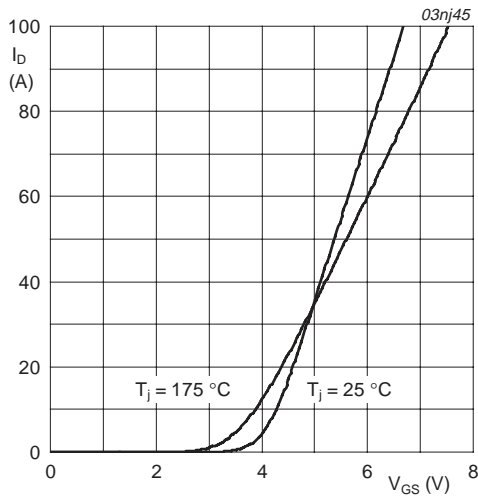

$V_{DS} = 25\text{ V}$

Fig 13. Transfer characteristics: drain current as a function of gate-source voltage; typical values

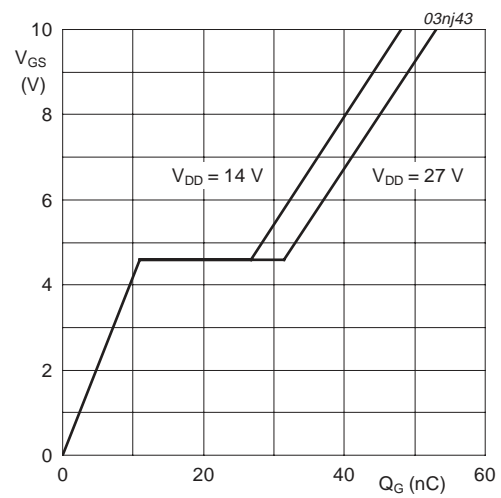

$T_j = 25\text{ °C}; I_D = 25\text{ A}$

Fig 14. Gate-source voltage as a function of gate charge; typical values

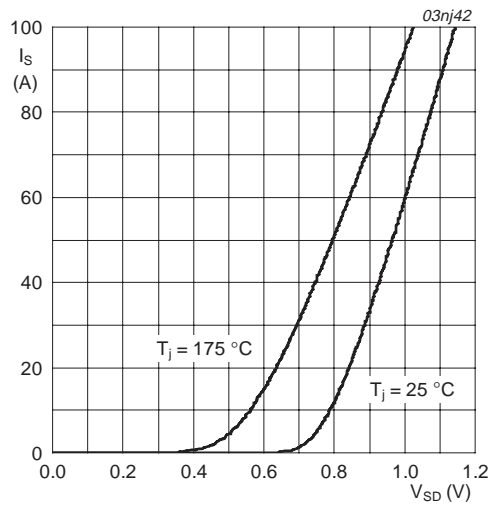

$V_{GS} = 0\text{ V}$

Fig 15. Source (diode forward) current as a function of source-drain (diode forward) voltage; typical values

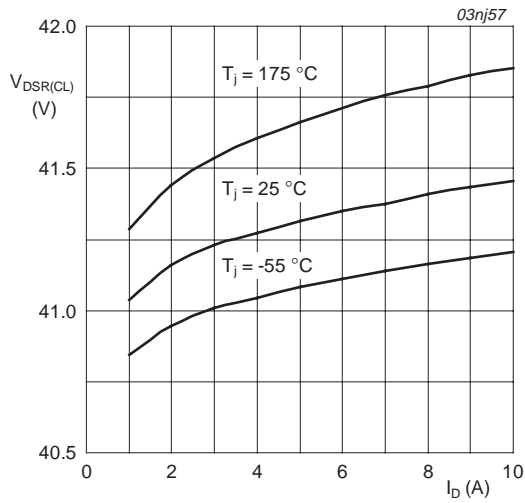

$I_{GD(CL)} = -2 \text{ mA}$

Fig 16. Drain-source clamping voltage as a function of drain current; typical values

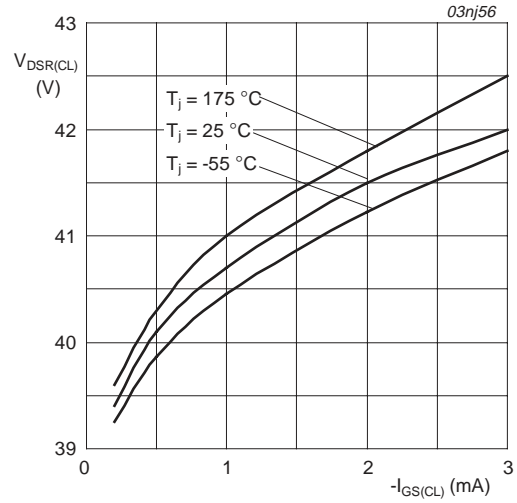

$I_D = 10 \text{ A}$

Fig 17. Drain-source clamping voltage as a function of gate-source clamping current; typical values

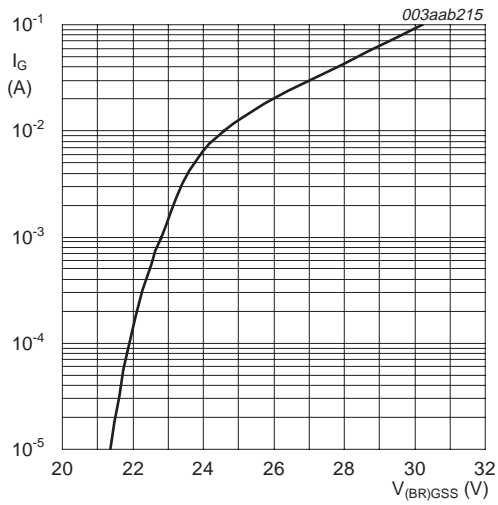
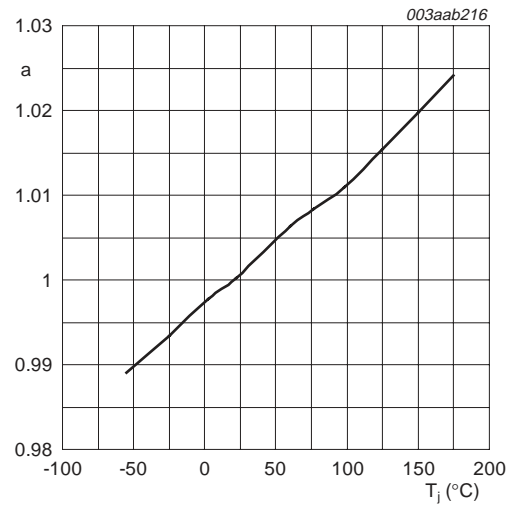

Fig 18. Source-gate clamping current as a function of source-gate clamping voltage; typical values



$$a = \frac{V_{(BR)GSS}}{V_{(BR)GSS(25^\circ\text{C})}}$$

Fig 19. Normalized source-gate clamping voltage as a function of junction temperature; typical values

7. Package outline

Plastic single-ended package; heatsink mounted; 1 mounting hole; 3 leads

SOT78C

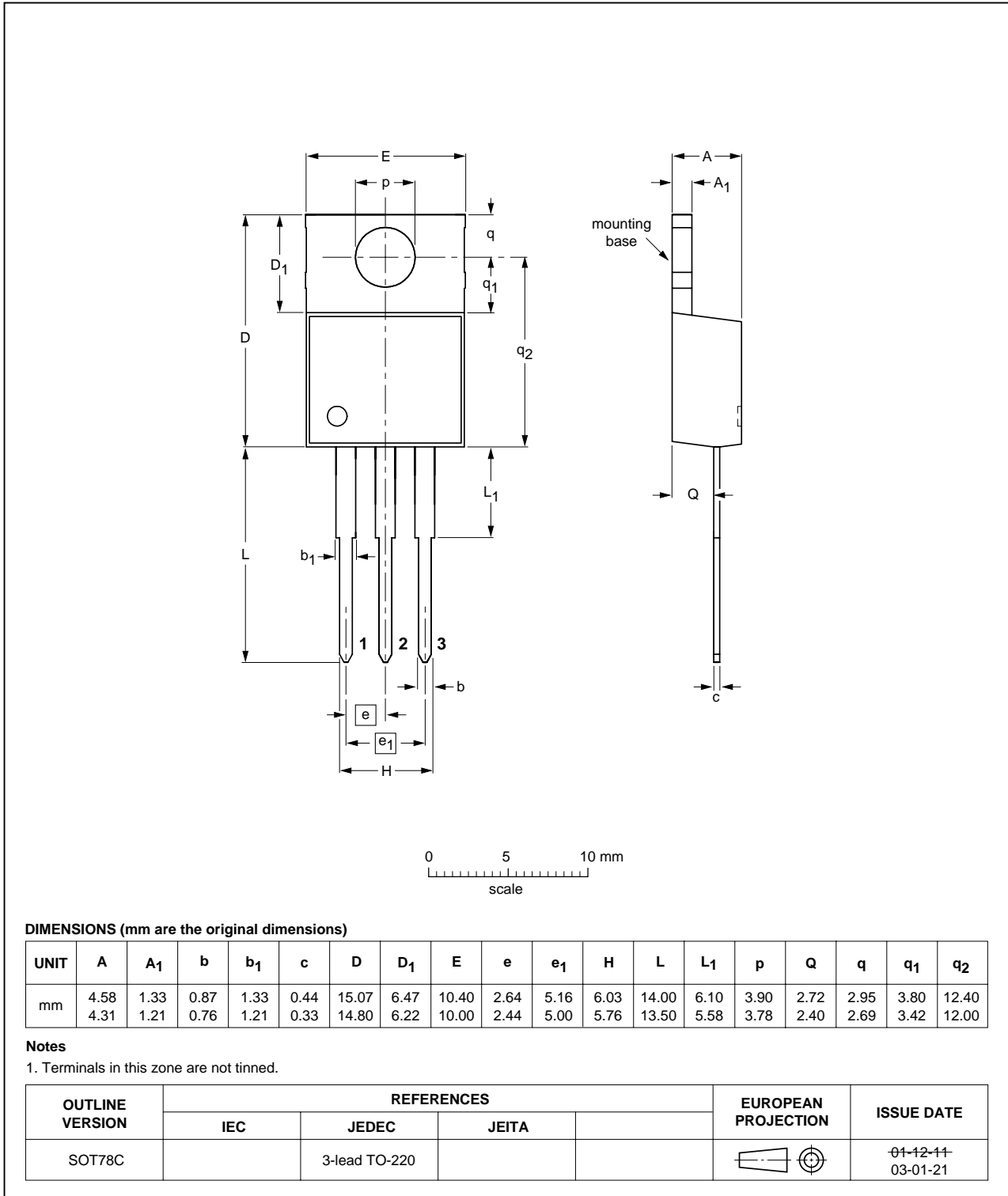

Fig 20. Package outline SOT78C (3-lead TO-220)

8. Revision history

Table 6: Revision history

Document ID	Release date	Data sheet status	Change notice	Doc. number	Supersedes
BUK7L11-34ARC_4	20051216	Product data sheet	-	-	BUK7L11_34ARC-03
Modifications:					<ul style="list-style-type: none"> The format of this data sheet has been redesigned to comply with the new presentation and information standard of Philips Semiconductors. Figure 18 and Figure 19 added.
BUK7L11_34ARC-03	20031203	Product data	-	9397 750 12163	BUK7L11_34ARC-02
Modifications:					<ul style="list-style-type: none"> Avalanche ruggedness parameter description in limiting values changed from: 'non-repetitive drain-source avalanche energy' to 'non-repetitive drain-source clamp energy'.
BUK7L11_34ARC-02	20030522	Product data	-	9397 750 11472	BUK7L11_34ARC-01
Modifications:					<ul style="list-style-type: none"> Typical values of I_{DSS} added to characteristics table.
BUK7L11_34ARC-01	20030423	Product data	-	9397 750 11178	-

9. Data sheet status

Level	Data sheet status ^[1]	Product status ^{[2] [3]}	Definition
I	Objective data	Development	This data sheet contains data from the objective specification for product development. Philips Semiconductors reserves the right to change the specification in any manner without notice.
II	Preliminary data	Qualification	This data sheet contains data from the preliminary specification. Supplementary data will be published at a later date. Philips Semiconductors reserves the right to change the specification without notice, in order to improve the design and supply the best possible product.
III	Product data	Production	This data sheet contains data from the product specification. Philips Semiconductors reserves the right to make changes at any time in order to improve the design, manufacturing and supply. Relevant changes will be communicated via a Customer Product/Process Change Notification (CPCN).

[1] Please consult the most recently issued data sheet before initiating or completing a design.

[2] The product status of the device(s) described in this data sheet may have changed since this data sheet was published. The latest information is available on the Internet at URL <http://www.semiconductors.philips.com>.

[3] For data sheets describing multiple type numbers, the highest-level product status determines the data sheet status.

10. Definitions

Short-form specification — The data in a short-form specification is extracted from a full data sheet with the same type number and title. For detailed information see the relevant data sheet or data handbook.

Limiting values definition — Limiting values given are in accordance with the Absolute Maximum Rating System (IEC 60134). Stress above one or more of the limiting values may cause permanent damage to the device. These are stress ratings only and operation of the device at these or at any other conditions above those given in the Characteristics sections of the specification is not implied. Exposure to limiting values for extended periods may affect device reliability.

Application information — Applications that are described herein for any of these products are for illustrative purposes only. Philips Semiconductors makes no representation or warranty that such applications will be suitable for the specified use without further testing or modification.

11. Disclaimers

Life support — These products are not designed for use in life support appliances, devices, or systems where malfunction of these products can reasonably be expected to result in personal injury. Philips Semiconductors

13. Contact information

For additional information, please visit: <http://www.semiconductors.philips.com>

For sales office addresses, send an email to: sales.addresses@www.semiconductors.philips.com

customers using or selling these products for use in such applications do so at their own risk and agree to fully indemnify Philips Semiconductors for any damages resulting from such application.

Right to make changes — Philips Semiconductors reserves the right to make changes in the products - including circuits, standard cells, and/or software - described or contained herein in order to improve design and/or performance. When the product is in full production (status 'Production'), relevant changes will be communicated via a Customer Product/Process Change Notification (CPCN). Philips Semiconductors assumes no responsibility or liability for the use of any of these products, conveys no licence or title under any patent, copyright, or mask work right to these products, and makes no representations or warranties that these products are free from patent, copyright, or mask work right infringement, unless otherwise specified.

12. Trademarks

Notice — All referenced brands, product names, service names and trademarks are the property of their respective owners.

TrenchMOS — is a trademark of Koninklijke Philips Electronics N.V.

14. Contents

1	Product profile	1
1.1	General description	1
1.2	Features	1
1.3	Applications	1
1.4	Quick reference data	1
2	Pinning information	1
3	Ordering information	2
4	Limiting values	2
5	Thermal characteristics	4
5.1	Transient thermal impedance	4
6	Characteristics	5
7	Package outline	11
8	Revision history	12
9	Data sheet status	13
10	Definitions	13
11	Disclaimers	13
12	Trademarks	13
13	Contact information	13



© Koninklijke Philips Electronics N.V. 2005

All rights are reserved. Reproduction in whole or in part is prohibited without the prior written consent of the copyright owner. The information presented in this document does not form part of any quotation or contract, is believed to be accurate and reliable and may be changed without notice. No liability will be accepted by the publisher for any consequence of its use. Publication thereof does not convey nor imply any license under patent- or other industrial or intellectual property rights.

Date of release: 16 December 2005
Document number: BUK7L11-34ARC_4

Published in The Netherlands