

DESCRIPTION

The EV9943-Q-00A demonstrates MPS's MP9943, a high-frequency, synchronous, rectified, step-down converter with built-in high-side and low-side power MOSFETs. The MP9943 offers a very compact solution to achieve a 3A peak output current with excellent load and line regulation over a wide input supply range. The MP9943 has synchronous mode operation for higher efficiency over the output current load range.

Current-mode operation provides fast transient response and eases loop stabilization.

Full protection features includes over-current protection and thermal shutdown.

The MP9943 requires a minimal number of readily-available components is available in a space-saving QFN8 (3mm x 3mm) package.

ELECTRICAL SPECIFICATION⁽¹⁾

Parameter		Symbol	Value
Input Voltage	Continuous	V_{IN}	12V Typical
	Transient		36V Max
Output Voltage		V_{OUT}	5V
Output Current		I_{OUT}	3A Peak

Notes:

- For different Input/output voltage specs and different output capacitor/inductor may need change the application circuit parameters.

FEATURES

- Wide 4V to 30V Continuous Operating Input Range
- 36V Input Transient Tolerance
- 85mΩ/55mΩ Low $R_{DS(ON)}$ Internal Power MOSFETs
- High-Efficiency Synchronous Mode Operation
- 410kHz Switching Frequency
- Synchronizes from 200kHz-to-2.2MHz External Clock
- High Duty Cycle for Automotive Cold-crank
- Internal Power-Save Mode
- Internal Soft-Start
- Power Good Indicator
- Over Current Protection and Hiccup
- Thermal Shutdown
- Output Adjustable from 0.8V
- Available in an QFN8 (3mm x 3mm) Package

APPLICATIONS

- General Consumer
- Multi-Function Printers (MFP)
- Distributed Power Systems

All MPS parts are lead-free and adhere to the RoHS directive. For MPS green status, please visit MPS website under Products, Quality Assurance page.

"MPS" and "The Future of Analog IC Technology" are registered trademarks of Monolithic Power Systems, Inc.

EV9943-Q-00A EVALUATION BOARD



Board Number	MPS IC Number
EV9943-Q-00A	MP9943GQ

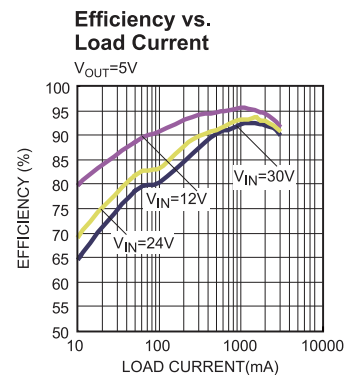

EVALUATION BOARD SCHEMATIC

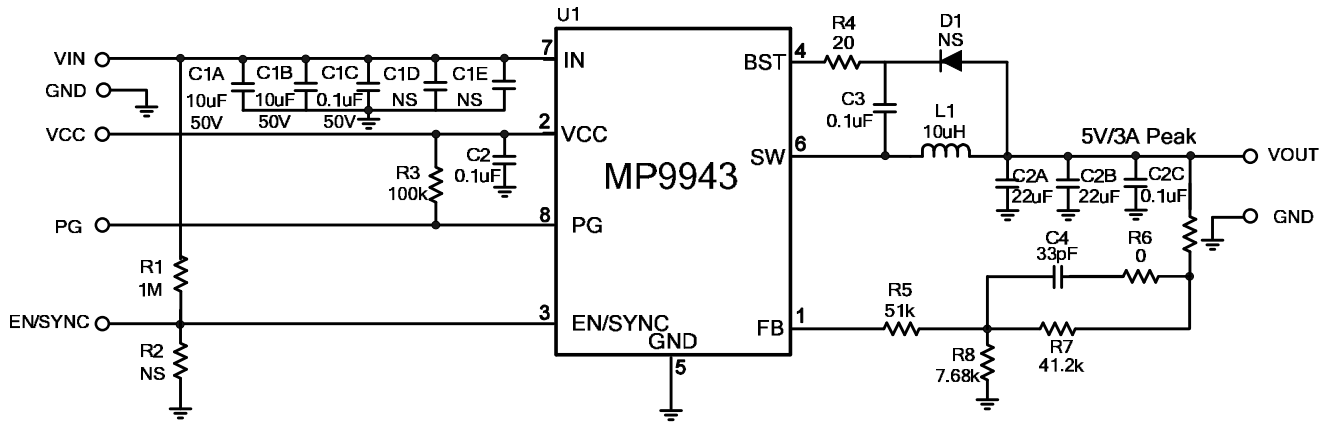

EV9943-Q-00A BILL OF MATERIALS

Qty	Ref	Value	Description	Package	Manufacturer	Manufacturer P/N
2	C1A,C1B	10 μ F	Ceramic Cap., 50V, X7R	1210	muRata	GRM32ER71H106KA12L
1	C1C	0.1 μ F	Ceramic Cap., 50V, X7R	0603	muRata	GRM188R71H104KA93D
2	C2A,C2B	22 μ F	Ceramic Cap., 16V, X7R	1210	muRata	GRM32ER71C226KE79
3	C2, C2C, C3	0.1 μ F	Ceramic Cap., 16V, X7R	0603	muRata	GRM188R71C104KA01D
1	C4	33pF	Ceramic Cap., 50V, C0G	0603	muRata	GRM1885C1H330JA01D
2	C1D, C1E	NS				
1	D1	NS				
1	L1	10 μ H	Inductor, 33m Ω DCR, 4A	SMD	Würth	744314101
1	R1	1M	Film Res., 5%	0603	Yageo	RC0603JR-071ML
1	R3	100k	Film Res., 1%	0603	Yageo	RC0603FR-07100KL
1	R4	20	Film Res., 1%	0603	Yageo	RC0603FR-0720RL
1	R5	51k	Film Res., 1%	0603	Yageo	RC0603FR-0751KL
1	R6	0	Film Res., 5%	0603	Yageo	RC0603FR-070RL
1	R7	41.2k	Film Res., 1%	0603	Yageo	RC0603FR-0741K2L
1	R8	7.68k	Film Res., 1%	0603	Yageo	RC0603FR-077K68L
1	R9	10	Film Res., 1%	0603	Yageo	RC0603FR-0710RL
1	R2	NS				
1	U1		Step-Down Regulator	QFN8(3mmX3mm)	MPS	MP9943GQ

EVB TEST RESULTS

Performance waveforms are tested on the evaluation board.

$V_{IN} = 12V$, $V_{OUT} = 5V$, $L = 10\mu H$, $T_A = 25^\circ C$, unless otherwise noted.

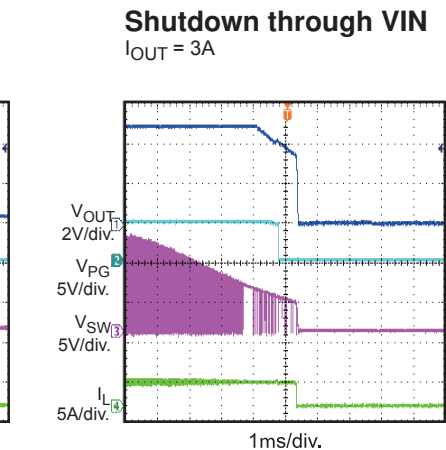
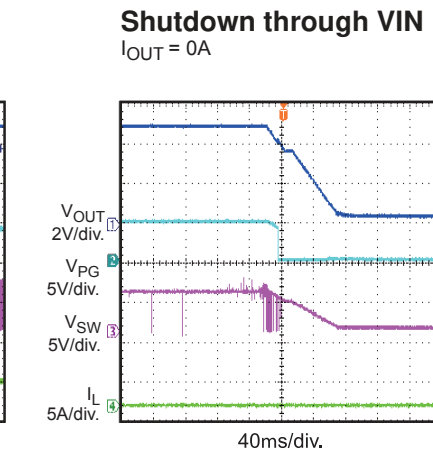
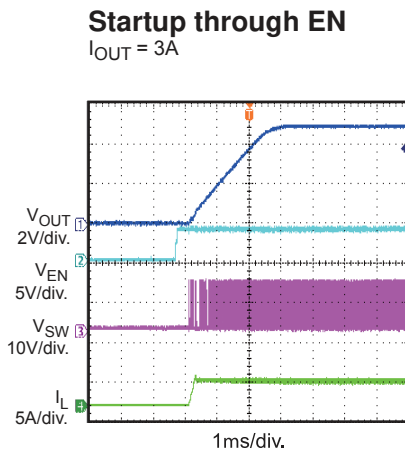
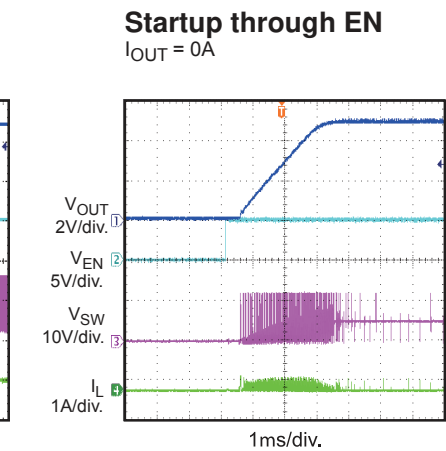
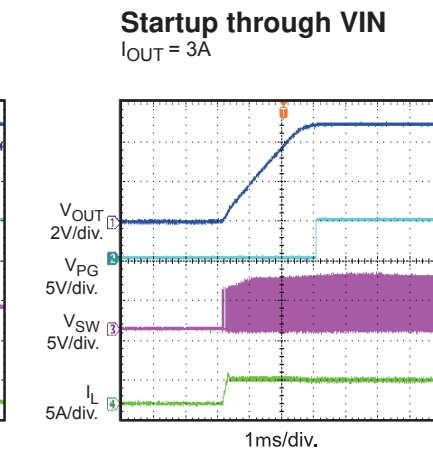
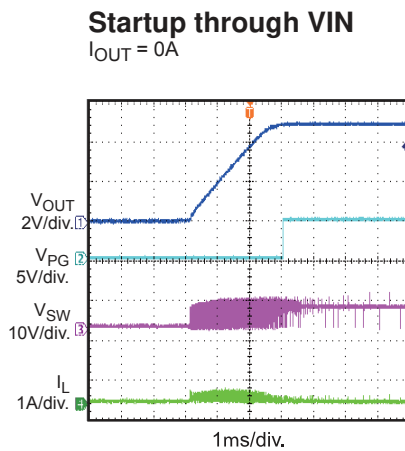
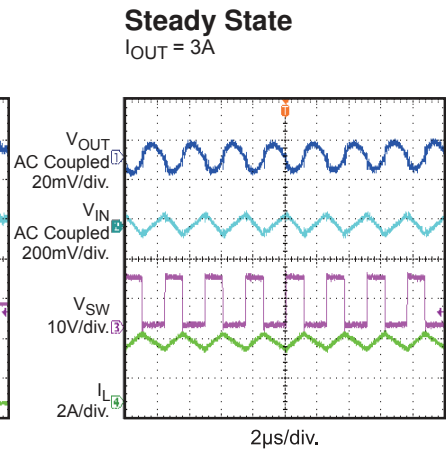
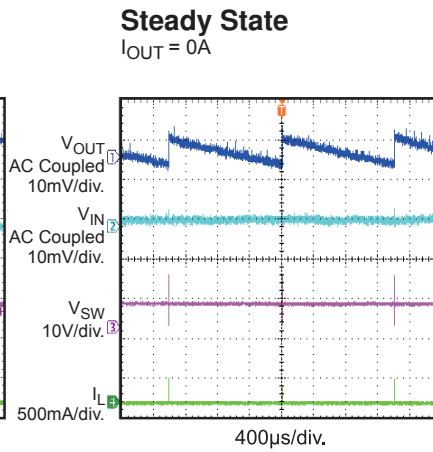
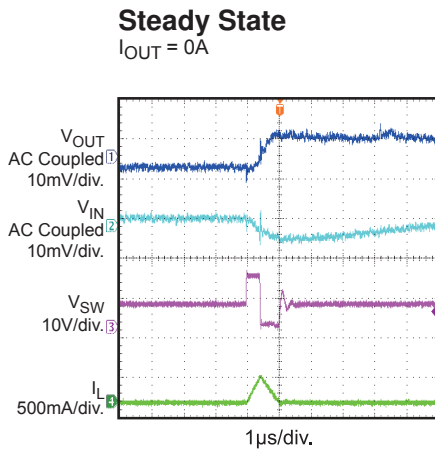

EVB TEST RESULTS (continued)

Performance waveforms are tested on the evaluation board.

 $V_{IN} = 12V$, $V_{OUT} = 5V$, $L = 10\mu H$, $T_A = 25^\circ C$, unless otherwise noted.

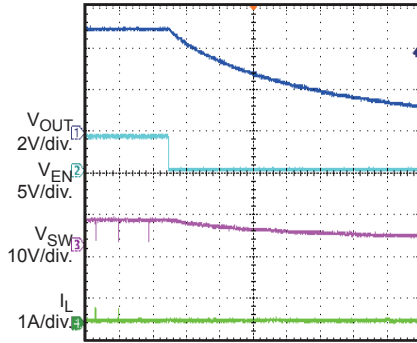
Shutdown through EN
 $I_{OUT} = 0A$

400ms/div.

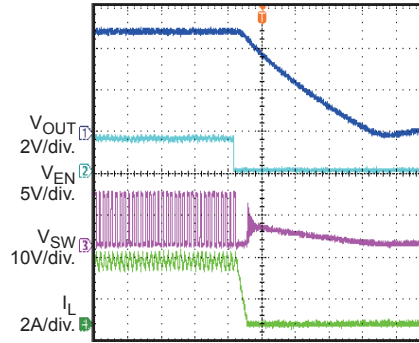
Shutdown through EN
 $I_{OUT} = 3A$

20µs/div.

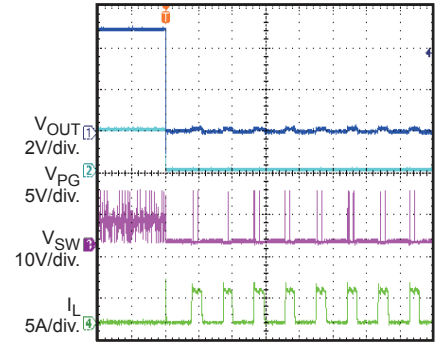
SCP Entry
 $I_{OUT} = 0A$ to Short Circuit

10ms/div.

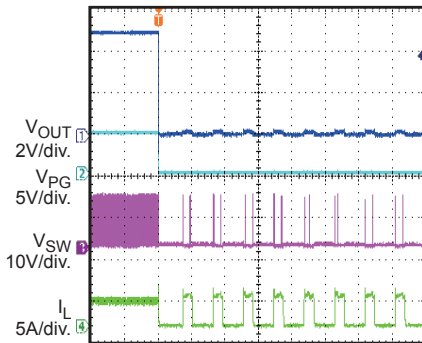
SCP Entry
 $I_{OUT} = 3A$ to Short Circuit

10ms/div.

SCP Recovery

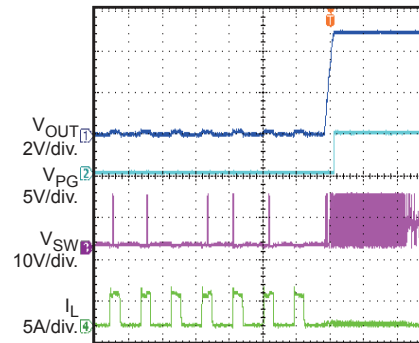
 Short Circuit to $I_{OUT} = 0A$

10ms/div.

SCP Recovery

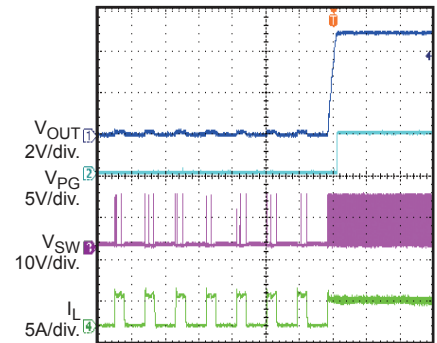
 Short Circuit to $I_{OUT} = 3A$

10ms/div.

QUICK START GUIDE

1. Connect the positive and negative terminals of the load to the VOUT and GND pins, respectively.
2. Preset the power supply output between 6.5V and 30V, and then turn off the power supply.
3. Connect the positive and negative terminals of the power supply output to the VIN and GND pins, respectively.
4. Turn the power supply on. The board will automatically start up.
5. To use the Enable function, apply a digital input to the EN/SYNC pin. Drive EN higher than 1.4V to turn on the regulator, or less than 1.25V to turn it off.
6. To use the external synchronous function to adjust the switching frequency, apply an external clock signal to EN/SYNC pin.

NOTICE: The information in this document is subject to change without notice. Please contact MPS for current specifications. Users should warrant and guarantee that third party Intellectual Property rights are not infringed upon when integrating MPS products into any application. MPS will not assume any legal responsibility for any said applications.