

802.11b/g Wireless LAN Module / Device Server

UDP/SLIP (BISM Form Factor Compatible)

Part Number: WISMC03BI



1. General Description

EZURiO's 802.11b/g SLIP Wireless LAN Module is a fully integrated and qualified wireless device server sub-system, designed to make it simple to embed 802.11 connectivity. It has been designed to be pin compatible with the footprint of Siemens MC55 GPRS modules, allowing designers to design one pcb to support either GPRS or Wireless LAN connectivity.

Unlike other wireless modules all of the necessary drivers, protocol stack, security algorithms up to the host TCP/IP interface are integrated, along with a high performance antenna. The 802.11b/g SLIP Wireless LAN module is designed for applications with an existing host processor running a TCP/IP stack and provides a fast and efficient way to convert a product from a wired to a wireless connection. It enables designers to add wireless internet connectivity to almost any device with a serial port and TCP/IP stack. The module is designed for the lowest cost of integration and ownership. It is ideal for enabling M2M applications.

The module is a dual processor design, dedicating one processor to the 802.11b/g baseband with a second powerful ARM7 processor, with 16MB of SRAM and 64MB of flash memory running the wireless drivers, UDP stack with SLIP interface and command interpreter. Connection to the host device is via a high speed 921,600 bps UART, with an additional twelve GPIO lines and two 10 bit ADCs. The module has a comprehensive set of commands giving high level access to wireless network management, simplifying the task of connecting to the 802.11 infrastructure.

The UART is used to carry both control and data frames. Frames transferred across this interface are encapsulated in a simple SLIP protocol. Data frames are presented as 802.3 packets; control frames employ high level commands to configure and control the module's operation. Because the module integrates the 802.11b/g drivers, it provides independence from the proprietary nature of wireless silicon implementations, saving a significant amount of development time and making integration totally independent of the host operating system.

The twelve GPIO and two analogue input lines can be configured using commands to provide control or monitoring of simple devices such as switches or LEDs without requiring any external processing.

The module includes a high sensitivity, high gain antenna which provides excellent range. Typical open field performance yields an operating range of over 100 metres. A second 50 Ohm U.FL connection is provided for an external antenna. This can be used in place of the internal antenna, or in conjunction with the internal antenna to implement antenna diversity for improved receive performance.

Support is provided for low power modes that make the Wireless LAN module particularly applicable to battery powered installations. It has been designed to ensure the best co-existence with other devices operating within the same frequency spectrum and has hardware support designed into the module for 2 and 3-wire Bluetooth co-existence schemes.

The Wireless LAN module is supplied in a small pcb form factor (22.8mm x 33.8mm x 7.6mm), that connects to a main pcb using a 40 way Hirose connector which is pin compatible with the EZURiO Bluetooth Intelligent Serial Module BISMII. The module is Lead-free and RoHS compliant and supports an industrial operational temperature range of -40°C to +85°C.

The module has FCC modular certification, Industry Canada certification and CE approval. These approvals allow users to simplify or bypass RF regulatory testing, enhancing time to market and reducing approvals time and cost.

Applications

- POS Equipment
- Medical Equipment
- Telematics
- Metering Applications
- Automotive Applications
- Street Furniture
- Industrial Automation

2. Features

Feature	Implementation
Wireless Specification	
Standards Supported	IEEE 802.11b, IEEE 802.11g
Frequency	2.412 – 2.484 GHz
Channels	11 channels – USA 13 channels – Europe 4 channels – France (EIRP > 10mW outdoors) 14 channels – Japan <i>Programmable selection of region</i>
Max Transmit Power	802.11b: +15 dBm @ antenna connector 802.11b: +17 dBm from integrated antenna 802.11g: +13 dBm @ antenna connector 802.11g: +15 dBm from integrated antenna
Receive Sensitivity	802.11b: -91dBm @ 1 Mbps, -84dBm @ 11Mbps 802.11g: -84dBm @ 6Mbps, -67dBm @ 54Mbps
Data Rates	54Mbps – 1Mbps with automatic fallback
Data Transfer rate	Up to 921.6kbps (limited by UART)
Modulation Schemes	802.11b – BPSK, QPSK, CCK, DSSS 802.11g – BPSK, QPSK, 16-QAM, 64-QAM, OFDM
Range	Up to 100 metres free space
Connection Modes	Infrastructure and ad-hoc (IBSS)
Antenna Modes	
Integrated Antenna	High performance +2dBi multilayer ceramic
External Antenna	50 Ohm U.FL connection
Antenna Diversity	Supported using integrated and external antennae
UART Interface	
Serial Interface	RS-232 bi-directional for commands and data 16550 compatible
Baud Rate	Configurable from 9,600 to 921,600bps
Bits	8
Parity	Odd, even, none
Stop bits	1 or 2
Default Serial parameters	115200,n,8,1
Levels	3.0V CMOS
Modem Control	DTR, DSR, DCD, RI, RTS, CTS †
General Purpose Interface	
I/O	12 general purpose I/O pins, 3.0V CMOS†
ADC	2 ADC inputs. 10 bit, 3.0V max

†DSR, DTR, RI and DCD are configurable either as GPIO or as modem control lines.

Security

Open Connection
WEP encryption 64 and 128 bit options
WPA-PSK
WPA2 Enterprise & Personal
IEEE 802.11i-PSK (AES-CCMP)
TKIP Encryption
SSL2 / SSL3 / TLS1
Hardware Acceleration for security features
(Encryption modes require an external supplicant)

Protocols

Network Drivers 802.11b, 802.11g
Internet IPv4, UDP, SLIP

Power Consumption

Powersave modes IEEE Powersave Modes 0,1,2 & 5
Current Consumption Less than 250mA during data transfer with a configurable low power mode less than 5mA

Supply Voltage

Supply 3.3V – 5.0V DC
Regulation On-board regulators, brown-out detection and watchdog

Embedded Wireless Processor System

Specification ARM7 with 16Mb SRAM and 64Mb Flash
WLAN functions Search, Attach, Detach, Set Region, etc.
Upgradeability Firmware upgradeable via UART

Coexistence / Compatibility

Bluetooth 2-wire and 3-wire hardware coexistence schemes supported
Pin compatible with EZURiO BISM Bluetooth modules

Connections

Interface 40 way Hirose DF-12 Connector
External Antenna U.FL connector for 50 Ohm antenna

Physical

Dimensions 22.8mm x 33.8mm x 7.6mm
Weight 8 grams

Environmental

Operating Temperature Low Power Mode: -40°C to +85°C
Continuous transmission: -40°C to +60°C
Minimum cold start temperature: -25°C
Storage Temperature -50°C to +125°C

Approvals

FCC Modular Approval PI405W
IC Industry Canada
CE & R&TTE Approved

Miscellaneous

Lead free Lead-free and RoHS compliant
Warranty 2 Years

2.1 Block Diagram

The module has a 40 way Hirose connector which provides a compatible pin out to the same form factor EZURiO Bluetooth Intelligent Serial Module.

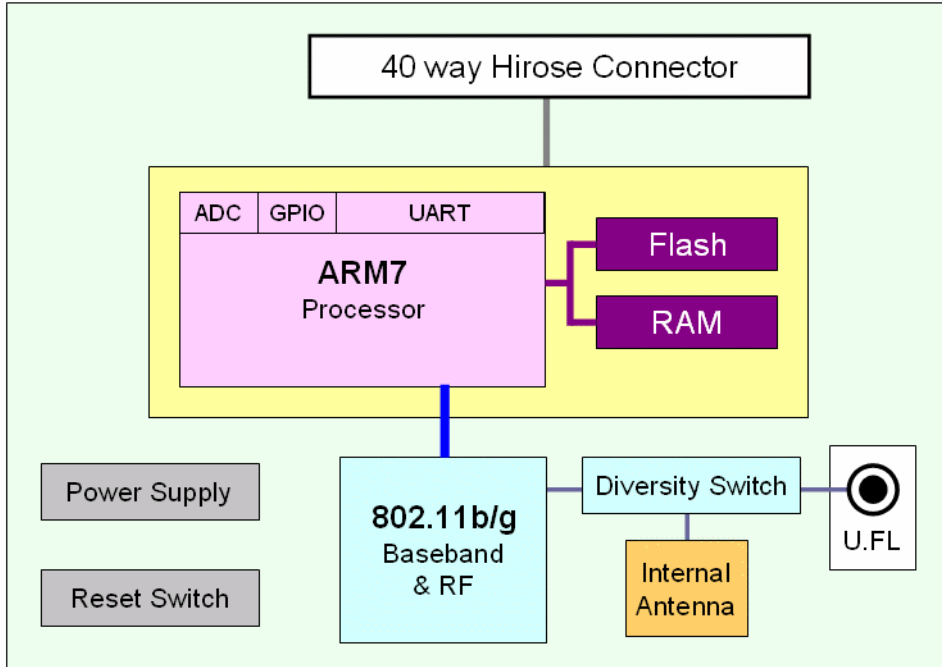

3. Mechanical

3.1 Wireless LAN Module Dimensional outline

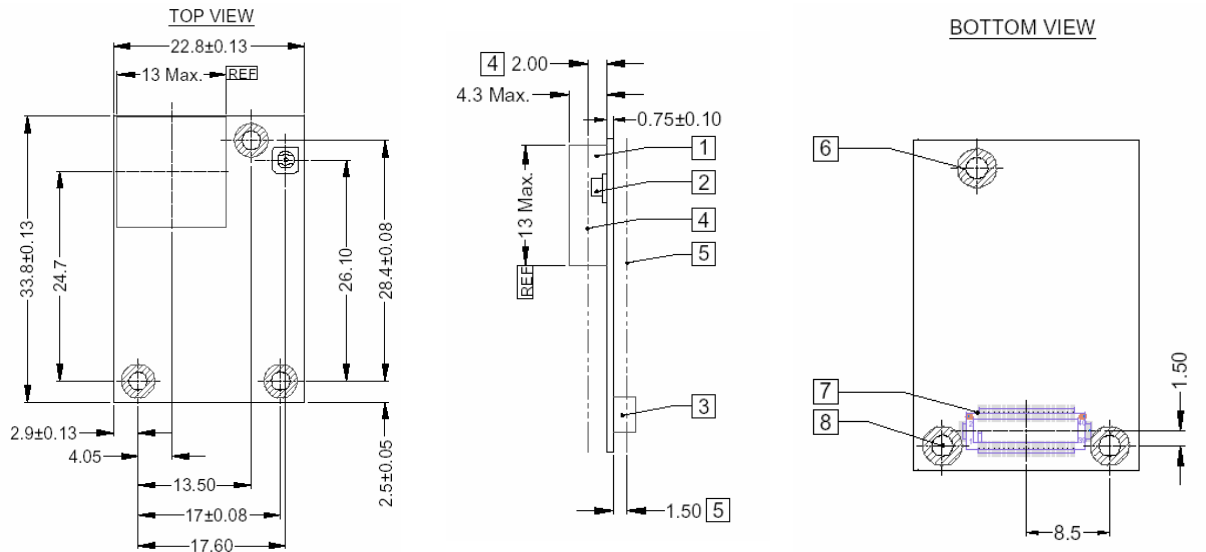

All dimensions in mm

Notes	
1	RF antenna
2	External Antenna connector (Hirose U.FL-R-SMT)
3	Board to board connector (Hirose connector)
4	2.0mm maximum top side component height (excluding antenna)
5	1.5mm maximum bottom side component height
6	3.8mm max. pcb clearance for fixings body (top and bottom)
7	40 way connector footprint
8	2.2 +/- 0.075 fixing holes x 3

The Module is equipped with a 40-pin 0.5mm pitch board-to-board connector that connects to the application platform.

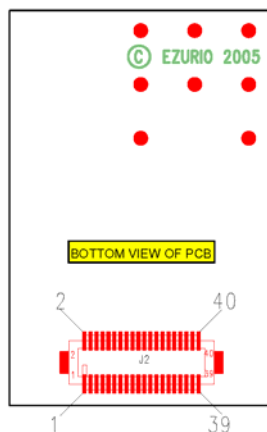

4. Electrical

4.1 40 way Hirose Pin Descriptions

The Hirose DF12C board-to-board connector on the module is a 40-pin double-row receptacle.

The table below defines the pin functions. The pin-out is as viewed from the underside of the Module.

Pin No.	Signal	Description
1	ADC 0	3.0 V Max
3	ADC 1	3.0 V Max
5	WLAN_ACTIVE	Output
7	N/C	
9	N/C	
11	GND	
13	RESET	Reset Input
15	GND	
17	N/C	
19	UART_CTS	Clear to Send Input
21	UART_TX	Transmit Data Output
23	UART_RTS	Request to Send Output
25	UART_RX	Receive Data Input
27	VCC_3V	3.0V Monitor
29	VCC_5V	Supply
31	VCC_5V	Supply
33	GPIO6	I/O for Host
35	GPIO7	I/O for Host
37	GPIO8	I/O for Host
39	GPIO9	I/O for Host

Pin No.	Signal	Description
2	GPIO1	I/O for Host.
4	GPIO2	I/O for Host
6	UART_RI	RING or GPIO12
8	UART_DCD	DCD or GPIO13
10	UART_DSR	DSR or GPIO10
12	UART_DTR	DTR or GPIO11
14	GPIO4	I/O for Host
16	GPIO5	I/O for Host
18	GND	
20	N/C	
22	WAKEUP	Reserved
24	BT_PRIORITY	Input
26	N/C	
28	VCC_5V	Supply
30	GND	
32	N/C	
34	N/C	
36	GND	
38	GND	
40	BT_STATE	Input

Notes:

The reset circuitry within the module incorporates a brown-out detector. The reset pin has a fixed 10kOhm pull down resistor to ground, followed by a 10kOhm resistor feeding the base of a transistor.

GPIO lines can be configured through software to be either inputs or outputs. At reset, all GPIO lines, other than those that have dual functionality as modem control signals are configured as inputs.

UART_RX, UART_TX, UART_CTS, UART_RTS, UART_RI, UART_DCD, UART_DTR and UART_DSR are all 3.0v level logic. When the signal sits at 3.0V it is de-asserted. When the signal is at 0V it is asserted.

UART_RX, UART_TX, UART_CTS, UART_RTS are controlled directly by the module. The operation of UART_RI, UART_DCD and UART_DTR is user programmable.

Pin 27 (VCC_3V) may only be used for monitoring purposes. It must not be used as a current source.

Pin 22 (WAKEUP) will be used for future powersave functionality. It has an internal 100kOhm pull-up.

ADC inputs (pins 1 and 3) are read using commands over the UART.

UART_DSR is used to signal the module to enter Power Save Mode 2.

Pins marked N/C may have internal connections within the module and should not be connected to any external circuitry.

4.1 Electrical Specifications

4.1.1 Absolute Maximum ratings

Absolute maximum ratings for supply voltage and voltages on digital and analogue pins of the Module are listed below. Exceeding these values will cause permanent damage.

Parameter	Min	Max	Unit
Peak current of power supply		550	mA
Voltage at digital pins	-0.3	3.3	V
Voltage at VCC_5V pin	3.3	5	V

4.1.2 Recommended Operating Parameters

4.1.2.1 Power Supply

Signal Name	Pin No	Voltage level	Comments
VCC_5V	28, 29, 31	3.3V to 5.0V	$I_{typ} = 250mA$. All VCC_5V pins should be connected
GND	11,15,18,30,36,38		All six GND pins should be connected

4.1.2.2 Signal Levels for Interface and GPIO

Signal Type	Signal level	Signal level @ 0mA load	Signal level @ 4mA load
Input	$V_{ILmax} = 0.8V$ $V_{IHmin} = 2.1V$ $V_{IHmax} = 3.3V$		
Output		$V_{OLmax} = 0.2V$ $V_{OHmin} = 2.8V$	$V_{OLmax} = 0.4V$ $V_{OHmin} = 2.6V$

4.1.2.3 RS-232 Interface

Signal Name	Pin No	I / O	Comments
UART_TX	21	O	This pin must NOT be pulled low by external circuitry.
UART_RX	25	I	
UART_CTS	19	I	
UART_RTS	23	O	
UART_DSR	10	I	Used to place the module in Powersave 2 mode
UART_DTR	12	O	Direction is programmable – default is Output
UART_RI	6	O	Direction is programmable – default is Output
UART_DCD	8	O	Direction is programmable – default is Output

4.1.2.4 General Purpose I / O and ADC

Signal Name	Pin No	I / O	Comments
GPIO 1 - 9	2,4,14,16,33,35,37, 39	I or O	There is no GPIO3
GPIO 10 – 13	10,12,6,8	I or O	Shared with DSR, DTR, RI, DCD
ADC0, ADC1	1, 3	I	Range 0 – 3.0V

4.1.2.5 Other Functions

Signal Name	Pin No	I / O	Comments
RESET	13	I	Active high. The RESET line has a fixed 10kOhm pull down resistor to ground, followed by a 10kOhm resistor feeding the base of a transistor.
3VOUT	27	O	Used to monitor the state of the regulated supply within the module. THIS PIN MUST NOT BE USED TO POWER AN EXTERNAL CIRCUIT.

4.1.2.6 Signal Levels for Bluetooth Coexistence and Wakeup Pins

Signal Type	Signal level
Input	$V_{ILmax} = 1.0V$ $V_{IHmin} = 1.5V$ $V_{IHmax} = 3.5V$
Output	$V_{OLmax} = 0.4V$ $V_{OHmin} = 2.4V$

4.1.2.7 Bluetooth Coexistence

Signal Name	Pin No	I / O	Comments
WLAN_ACTIVE	5	O	
BT_PRIORITY	24	I	If unused, this pin should be pulled low.
BT_STATE	40	I	If unused, this pin should be pulled low.

4.1.2.8 Wakeup

Signal Name	Pin No	I / O	Comments
WAKEUP	22	I	Reserved for future use. The WAKEUP line has a fixed 100kOhm pull-up resistor.

5. RF Performance

5.1 Transmit Power (802.11g)

Conducted Transmit Power	Typ: +13 dBm
Antenna Gain (Integrated Antenna)	+2dBi typ.
Effective Transmit Power	Typ:+15dBmi

5.2 Transmit Power (802.11b)

Conducted Transmit Power	Typ: +15 dBm
Antenna Gain (Integrated Antenna)	+2dBi typ.
Effective Transmit Power	Typ:+17dBmi

5.3 Receive Sensitivity (802.11b)

Receive Sensitivity (11Mbps)	Typ: -84dBm
Antenna Gain (Integrated Antenna)	+2dBi typ
Effective Receive Sensitivity	-86dBm

5.4 Receive Sensitivity (802.11g)

Receive Sensitivity (6Mbps)	Typ: -82dBm
Antenna Gain (Integrated Antenna)	+2dBi typ
Effective Receive Sensitivity	-84dBm

6. Functional Description

The Wireless LAN module is designed for use with a host system that implements a TCP/IP stack. It provides a UDP stack and SLIP interface to allow fast integration. The integrated, high performance antenna together with the RF and baseband circuitry provides the Wireless LAN connectivity and the UART interface for a connection to a host system.

6.1 Interfaces

6.1.1 UART interface

Modem signal nomenclature can be a source of great confusion, particularly on devices which can be configured in either DCE (Data Communications Equipment) or DTE (Data Terminal Equipment) format. For the purpose of this data sheet all UART signals are defined on the assumption that the module is being used as a conventional DCE. I.e it is behaving like a serial PSTN modem.

UART_TX, UART_RX, UART_RTS and UART_CTS form a conventional asynchronous serial data port with handshaking, conforming to the ITU-T v.24 standard for DCE signalling. The interface is designed to operate correctly when connected to other UART devices such as a 16550A. Note that the signalling levels are a nominal 0V and 3.0V and are inverted with respect to the signalling on an RS232 cable. The interface is programmable over a variety of baud rates, with no, even or odd parity, one or two stop bits and hardware flow control. Non-standard baud rates are supported – for more information please contact EZURiO. Auto-bauding is not supported.

On power-up the UART defaults to 115200,n,8,1.

Note that there is no standardisation regarding the nomenclature of RX and TX across a DCE-DTE interface. Some implementations show TX(DCE) connected to TX(DTE) to give naming consistency across a cable, whereas other show TX driving RX to reflect logical port directions. Always check the direction of ports on DCE and DTE.

In a DCE mode, where the module is being driven as a peripheral by a host processor application, the UART signals should be connected according to the following scheme:

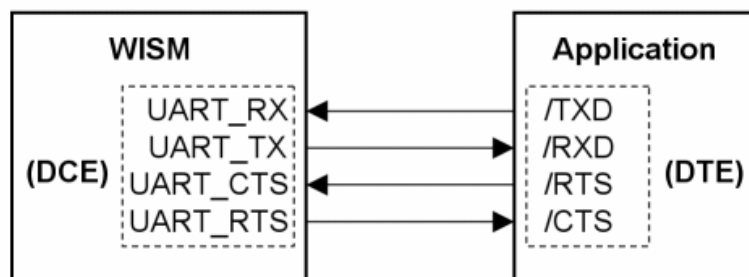

Port UART_TX transmits data to the application's /RXD input.

Port UART_RX receives data from the application's /TXD output.

Two-way hardware flow control is implemented by UART_RTS and UART_CTS. In DCE mode, UART_RTS is an OUTPUT and is active low. UART_CTS is an INPUT and is active low. These signals operate according to normal industry convention.

Some serial implementations link UART_CTS and UART_RTS to remove the need for handshaking. EZURiO does not recommend linking UART_CTS and UART_RTS other than for testing and prototyping. If these pins are linked and the host sends data at the point that the Wireless Module asserts its UART_RTS signal, then there is a significant risk that internal receive buffers will overflow which could lead to a loss of data. EZURiO recommend that the correct UART_CTS to UART_RTS handshaking protocol be adhered to in order to ensure proper operation.

The UART_DSR signal is an input to the module to place it in Powersave Mode 2.

The operation, meaning and direction of the UART_RI and UART_DCD signals is user programmable.

Note that the serial module output is at 3.0V CMOS logic levels. Level conversion must be added to interface with an RS-232 level compliant interface.

6.1.2 Bluetooth Coexistence

Three pins are provided to allow implementation of Bluetooth coexistence schemes, when the 802.11 module is collocated with a Bluetooth radio. These connect directly between the basebands of the two radios to ensure minimum interference. Both 2-wire and 3-wire coexistence schemes can be supported.

Coexistence requires that the Bluetooth radio meets at least version 1.2 of the Bluetooth standard and supports Adaptive Frequency Hopping (AFH).

6.1.3 GPIO Port

Twelve lines of programmable bi-directional input/outputs (I/O) are provided that can be accessed via the UART port with the IO family of commands. These can be used as data inputs or to control external equipment.

Each of the GPIO pins can be independently configured to be either an Input or Output. A selection of ports can be accessed synchronously.

Four of the lines (GPIO 10-13) are shared with modem control functions. If they are used to implement a fully featured UART, then they cannot be used for GPIO.

6.1.4 ADC

The Wireless LAN module provides access to two 10-bit ADCs. These provide an input range of 0V to 3.0v.

Suitable external scaling and over-voltage protection should be incorporated in your design.

Please refer to the WISM ADC Application Note AN017 for information on interfacing the ADC pins.

7. Firmware Features

7.1 Command Set

The module supports the following commands.

Details of the complete command list are provided in a separate Programming Guide, the following are provided as an overview.

Command	Parameters	Operation
UARTMODIFY	Baud: Baud rate (9600, 19200, 38400, 57600, 115200, 230400, 921600) Length: 8 bits (only allowed option) Parity: Even / Odd Stop: 1, 2	Configures the UART parameters.
SECURITY	Flag: none, WEP	Selects use of WEP security. (See firmware release notes for other security parameters)
KEY	Keysting: 10 or 26 Hex digits setting 64 or 128 bit encryption key	Sets the WEP encryption key. (See firmware release notes for other security parameters)
AUTHENTICATE	Flag: Open or closed	Selects authentication strategy to use in combination with WEP.
SEARCH		Performs a search for local Access Points.
ATTACH	Name: Alphanumeric AP SSID	Attaches the module to the specified Access Point.
DETACH		Detaches the module from the current Access Point.
BSSTYPE		Selects either AP or ad-hoc mode of operation.
CHANNEL	Channel: 1-11 (Europe), 1-13 (US) and 1-14 (Japan)	Sets the operating channel for an ad-hoc network.
MACADDRESS		Reads back the MAC address of the module.
POWERSAVE	Flag: Powersave mode (0,1,2,5)	Selects the power save mode.
GETRSSI		Reports signal strength information for the current AP connection.
GETREGION		Gets the current region for which the module is configured.
SETREGION		Sets the region.
INITADCCHANNEL		Initializes the ADC for a particular channel.
READADCCHANNEL		Reads the specified ADC channel.

CFGGPIOOUTPUT		Set PIO line(s) to be outputs
CFGGPIOINPUT		Set PIO line(s) to be inputs
SETGPIO		Set output line(s) high
CLEARGPIO		Set output line(s) low
READGPIO		Reads state of input GPIO line(s)

7.2 Power Saving

The module supports the Wireless LAN IEEE power saving function. When this power saving mode is enabled, the wireless LAN chipset goes to sleep when it is not actively receiving from the access point. The chipset wakes up on a regular basis to receive broadcast messages from the AP or to transmit or receive unicast messages. By using this technique the average power consumption of the chipset is reduced from around 250mA in active receive mode to less than 35mA. The EZURiO module offers IEEE power save operation in three different modes:

- Powersave mode 1: The wireless LAN chipset operates in IEEE powersave mode and the module microcontroller remains fully awake and ready to receive commands and data from the host. This mode of power saving reduces the average consumption of the module to <35mA.
- Powersave mode 2: The wireless LAN module operates in IEEE powersave mode and the module microcontroller is put into a very low power standby mode. The average current consumption in this mode is reduced to <5mA. In power save mode 2, UART_DSR is used by the host to indicate that the module can enter the low power state. When UART_DSR is de-asserted, the module microcontroller enters low power standby. The microcontroller will re-start when either a packet is received from the AP or the host requests it by asserting UART_DSR.
- Powersave mode 5: The modules default mode of start up is in Powersave mode 5. At start up the module automatically enters Power Save 5 mode. The average current consumption in this mode is reduced to <25mA. In this mode the module powers down the WLAN chipset, and awaits commands from the host. The host may only send the following commands:
 - UARTMODIFY
 - POWERSAVE
 - MACADDRESS
 - VER

In Powersave mode 5 no other commands will be accepted by the module until it has entered either Power Save 1 or Power Save 0 mode.

Powersave mode 1 requires beacons to be broadcast from an infrastructure access point. Therefore it is not available when operating in ad-hoc (IBSS) mode.

8. Application Information

8.1 Antenna Location

The antenna used on the Wireless LAN module is designed to be largely immune from the effects of proximity detuning. Normally, antennas operating at 2.4GHz are affected by their surroundings, so that great care is needed in their placement and orientation.

The Wireless LAN module can be used in most locations and orientations and is only marginally affected by the presence of a significant ground plane in close proximity.

The antenna distribution is close to isotropic, which means that the orientation of mounting has only a limited effect on the overall range. However the optimum range is achieved when the two antennae are directly facing each other

8.1.1 Example of Radiation Characteristics

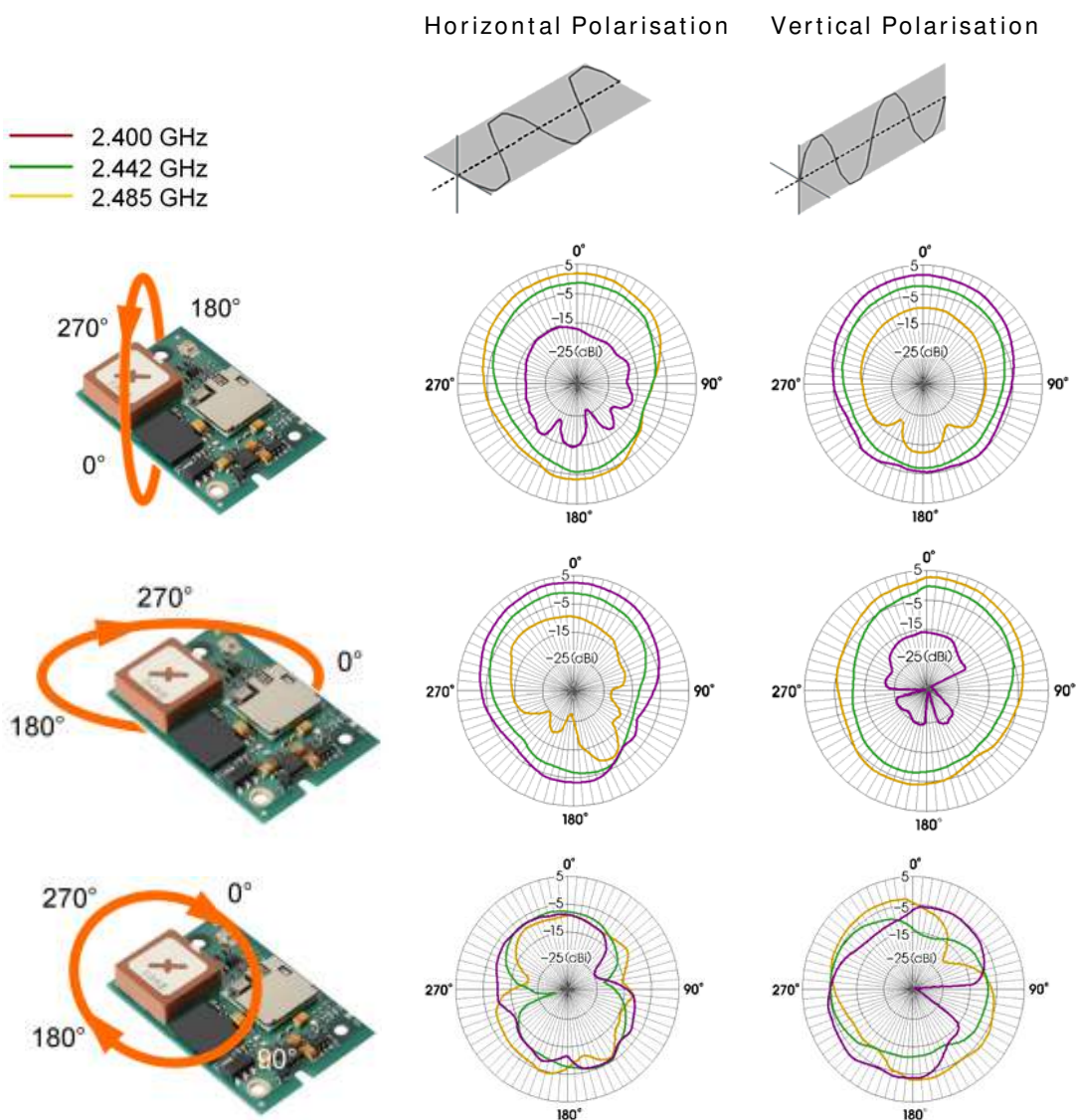

Typical Radiation Characteristics. Measured at 2.5 metres from a standard dipole.

The module should not be located in a sealed metal enclosure, as this will act as a Faraday cage and severely attenuate the radio signal.

The antenna finish may tarnish as a result of environmental conditions and handling. This is a cosmetic effect and does not affect the RF performance.

8.2 External Antenna

The approval of the module was performed using a 3dBi external antenna from RF Castle Electronics (www.rfcastle.com/pdf/RF-3dbi%20DipoleA.pdf). The antenna was connected using a short cable to convert from the U.FL connector on the module to a reverse SMA. The conditions of approval allow the use of an alternative antenna, but require that the resulting effective radiated power does not exceed that exhibited during the approvals testing.

To ensure that the approval is not affected, the TOTAL GAIN of the external antenna, including insertion loss of the connectors and cable must be less than 3dBi. If a higher gain is employed, then the pre-approved status of the module will be lost. Customers must also ensure that the frequency characteristic of their antenna matches that of the antenna used for approval. As antennae are tuned for their frequency band the use of a different antenna technology may result in a change in emissions outside the 2.4GHz band. It is the customer's responsibility to ensure that an external antenna does not negate the approval.

U.FL connectors are supplied from a number of connector manufacturers. Details of Hirose's mating U.FL connectors are available at http://www.hirose.co.jp/cataloge_hp/e32119372.pdf

8.3 Power Supply Considerations

The power supply for the Module must be a single voltage source within the range of 3.3 V to 5.0 V. It must be able to provide sufficient current for a transmit burst. This can rise to 550mA.

The Module includes on-board regulators to provide local 3.0V. This rail is accessible on pin 27 for monitoring purposes only. Under no circumstances should this pin be used to source current.

Power (VCC_5V) is provided via the board-to-board connector Pins 28, 29 and 31. All VCC_5V and GND pins should be connected to ensure that individual pin current capacities are not exceeded during transmit current peaks.

8.4 Power-On-Reset

The Module is provided with an active high reset pin (Hirose 40way DF12C connector pin 13). However, on the application of power, the Power On Reset circuit built into the Module will ensure that the unit starts correctly. The external reset signal allows the module to be reset under software control from the host. After a power on or reset operation, the module will de-assert the UART_RTS output and re-assert it when it is ready to receive commands.

8.5 Operational Temperature

The Wireless LAN module is designed to meet an operational temperature of -40°C to +85°C in normal operation where it is running in IEEE power save mode.

If the module is run in a mode that results in more frequent receive and transmit activity the operating temperature will need to be derated to ensure that overall module power dissipation limits are not exceeded. When the ambient temperature rises above 60°C the module should only be operated in powersave mode 1 or higher.

The Wireless LAN module can operate in temperatures as low as -40°C, but the cold start minimum temperature must not be below -25°C.

8.6 Board to board connector and stacking height

The WISM connects to a motherboard by means of a board-to-board connector that is supplied by Hirose. Mating headers from Hirose are available in different stacking heights, allowing the spacing between the WISM module and carrier pcb to be changed from 3.5mm to 5.0mm.

Item	Part number	Stacking height	HRS number
Receptacle on Module	DF12C-40DS-0.5V(86)	3.5 mm – 5 mm	CL537-0007-7-86
Headers DF12 series	DF12(3.5)-40DP-0.5V(86)	3.5 mm	CL537-0032-4-86
	DF12(4.0)-40DP-0.5V(86)	4.0 mm	CL537-0057-5-86
	DF12(5.0)-40DP-0.5V(86)	5.0 mm	CL537-0157-0-86

Notes: The headers listed above are with boss and metal fitting.
Suffix -86 denotes RoHS compliance.

8.7 Hirose Connector general specification

Parameter	Specification (40 pin Board to Board connector)
Number of Contacts	40
Quantity delivered	2000 Connectors per Tape & Reel
Voltage	50V
Current Rating	0.5A max per contact
Resistance	0.05 Ohm per contact
Dielectric Withstanding Voltage	500V RMS min
Operating Temperature	-45°C to +125°C
Contact Material	phosphor bronze (surface: gold plated)
Insulator	Material PA , beige natural
Stacking height	3.0 mm ; 3.5 mm ; 4.0 mm ; 5.0 mm
Insertion force	21.8N
Withdrawal force 1st to 50th	10N
Maximum connection cycles	50

See http://www.hirose.co.jp/cataloge_hp/e53700036.pdf for detail information on the PCB socket.

8.8 Mounting the Module onto the application platform

There are many ways to properly install the Module in the host device. An efficient approach is to mount the PCB to a frame, plate, rack or chassis. Fasteners can be M1.8 or M2 screws plus suitable washers, circuit board spacers, or customized screws, clamps, or brackets in 2.2mm diameter holes. Note that care should be taken to ensure the head of the fixing does not interfere with the circuit. Nylon fixings are recommended.

The antenna (brown square component on top side of PCB) must not be influenced by any other PCBs, components or by the housing of the host device. The proximity of the antenna to large metallic objects can affect the range and performance of the system. Designers should carefully consider the location of the Module and the type of enclosure material that is used.

To prevent mechanical damage, be careful not to force, bend or twist the Module. Be sure it is positioned flat against the host device.

8.8.1 Fixing Pillars

EZURiO in conjunction with Richco has designed a mounting pillar for use with the Wireless LAN Module. This allows the module to be securely held to a primary pcb using snap fit details. A variety of heights are available to accommodate different variants of Hirose stacked connectors. Pillars supporting a 3.5mm stacked board height can be supplied by EZURiO. These and alternative spacings can also be ordered directly from Richco.

Customer designs using these pillars should use 2.5mm diameter holes on a 1.6mm thick PCB.

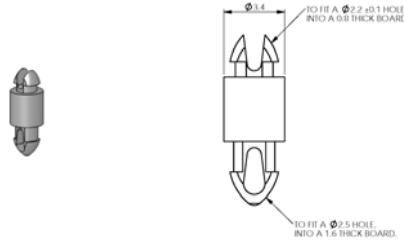

Board Spacing	Part number	Source	Matching HRS PCB Socket
3.6 mm	NPR2005-153-3.6	EZURiO / Richco	CL537-0032-4-86
4.1 mm	NPR2005-153-4.1	Richco	CL537-0057-5-86
5.1 mm	NPR2005-153-5.1	Richco	CL537-0157-0-86

8.9 Labelling

The label contains the Part number, firmware version loaded at manufacture, serial number and statutory approvals information.

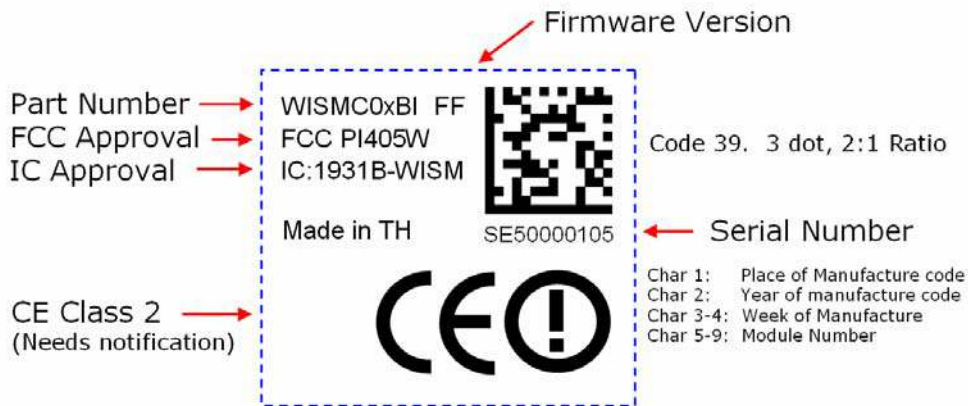

8.10 Ordering Information

The WISM described in this data sheet should be ordered using the part number below:

Part Number	Description
WISMC03BI	802.11b/g Wireless LAN SLIP Module (40 pin)

9. Qualification

9.1 Qualification Process

The following safety precautions must be observed during all phases of the operation, usage, service or repair of any application incorporating this Module. Manufacturers of the RF equipment are advised to convey the following safety information to users and operating personnel and to incorporate these guidelines into all manuals supplied with the product. Failure to comply with these precautions violates safety standards of design, manufacture and intended use of the product. EZURiO assumes no liability for customer failure to comply with these precautions.

9.2 Safety Information:

If the WLAN module is used in equipment that might be taken and operated on a commercial flight, the following safety instructions, or similar warning should be added to the user manual.

“Switch off the Wireless device before boarding an aircraft. Make sure it cannot be switched on inadvertently. The operation of wireless appliances in an aircraft is forbidden by many airlines to prevent interference with communications systems.”

9.3 Certifications

9.3.1 FCC and Industry Canada Statements

This device complies with part 15 of the FCC Rules. Operation is subject to the following two conditions: (1) This device may not cause harmful interference, and (2) this device must accept any interference received, including interference that may cause undesired operation.

Changes or modifications not expressly approved by the party responsible for compliance could void the user's authority to operate the equipment.

To inherit the modular approval, the antennas for this transmitter must be installed to provide a separation distance of at least 20 cm from all persons and must not be co-located or operating in conjunction with any other antenna or transmitter.

Co-location with other radio transmitting devices operating concurrently in the same band will require additional testing and certification.

Designers should note the distinction that the FCC makes regarding portable and mobile devices. Mobile devices are defined as products that are not used closer than 20cm to the human body, whereas portable devices can be used closer than 20cm to the body. In the case where the WISM module is used in a portable device, additional SAR testing must be performed on the complete product.

9.3.2 FCC Labelling requirement

If the FCC ID is not visible when the module is installed inside another device, then the outside of the device into which the module is installed must also display a label referring to the enclosed module. This exterior label can use wording such as the following: “Contains Transmitter Module FCC ID: PI405W” or “Contains FCC ID: PI405W.” Any similar wording that expresses the same meaning may be used.

9.3.3 National RF approvals

A list of the countries where the Module is approved will be provided by EZURiO as required. As a minimum the product is listed in Europe, Scandinavia, Canada and USA. EZURiO assumes no liability for customer failure to comply with national RF approval.

9.3.4 R&TTE Notification Requirement

The 2.4GHz band has some restrictions within the EU when the transmit power level is greater than 10mW (R&TTE Class 2). Because of this, it is designated within R&TTE as a non-harmonised band. Such products must be notified to the appropriate Notified Body within each country where it is placed on the market. EZURiO has notified the WISM module, but manufacturers incorporating it within their products and intending to sell these within Europe have a responsibility to notify the appropriate nominated body before commercial introduction. A list of nominated bodies is available at:

http://eur-lex.europa.eu/LexUriServ/site/en/oj/2003/c_302/c_30220031212en00010414.pdf

Further details on the notification procedure are given in EZURiO's Application Note AN016 - Notification Requirements for Wireless Products.

10. Related Documents

AN008 - Wireless Development Kit User Guide

AN016 - Notification Requirements for Wireless Products.

AN017 – Interfacing to the WISM ADC input

WHP-050004-1V0 Bluetooth and 802.11 Coexistence

WISM SLIP Programming Manual

Documents are available for download from www.ezurio.com

11. Development Kit

EZURiO offers a Wireless Development Kit for embedded developers which is unique in supporting Bluetooth, 802.11 and GSM/GPRS. It provides a simple design environment that can dramatically reduce the development time of wirelessly enabled products.

The Wireless Development Kit is available with EZURiO's pre-qualified Bluetooth and 802.11 Wireless LAN modules and accepts both 40 pin and 50 pin versions of these modules.

EZURiO's modules contain embedded protocol stacks, removing the need for complex programming on a host processor.

Features:

Bluetooth

- Complete, qualified Bluetooth stack
- Support for Version 2.0
- Upgradeable for Bluetooth 2.1 when available
- Simple AT style programming interface
- Audio codec evaluation kits available

802.11b/ g

- Enhanced drivers for low power operation
- Robust TCP/IP stack or UDP/SLIP
- Integrated Web Server (TCP/IP version only)
- Embedded interpreter (UWScript) for fast development (TCP/IP version only)

A range of codec audio development boards for Bluetooth voice applications are available. These can be plugged into the wireless development kit for rapid of audio applications.

For cellular applications, the Wireless Development Kit also supports Siemens' MC55 range of GSM/GPRS modules, which are pin compatible with EZURiO's wireless LAN module. This permits designers to develop products which can support either short range or wide area wireless connectivity, with incredibly fast time to market.

12. Disclaimers

EZURIO'S WIRELESS PRODUCTS ARE NOT AUTHORISED FOR USE AS CRITICAL COMPONENTS IN LIFE SUPPORT DEVICES OR SYSTEMS WITHOUT THE EXPRESS WRITTEN APPROVAL OF THE MANAGING DIRECTOR OF EZURIO LTD.

The definitions used herein are:

a) Life support devices or systems are devices which (1) are intended for surgical implant into the body, or (2) support or sustain life and whose failure to perform when properly used in accordance with the instructions for use provided in the labelling can reasonably be expected to result in a significant injury to the user.

b) A critical component is any component of a life support device or system whose failure to perform can be reasonably expected to cause the failure of the life support device or system, or to affect its safety or effectiveness.

EZURiO does not assume responsibility for use of any of the circuitry described, no circuit patent licenses are implied and EZURiO reserves the right at any time to change without notice said circuitry and specifications.

12.1 Data Sheet Status

EZURiO Ltd reserve the right to change the specification without prior notice in order to improve the design and supply the best possible product. Updated information, firmware and release notes will be made available on www.ezurio.com.

Please check with EZURiO Ltd for the most recent data before initiating or completing a design.