

SEZIONE B-B

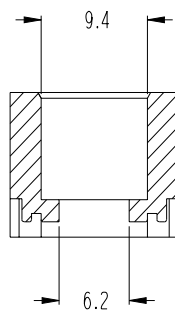

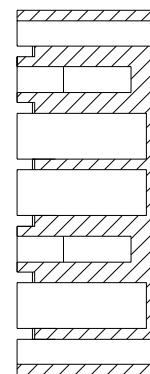

SEZIONE A-A

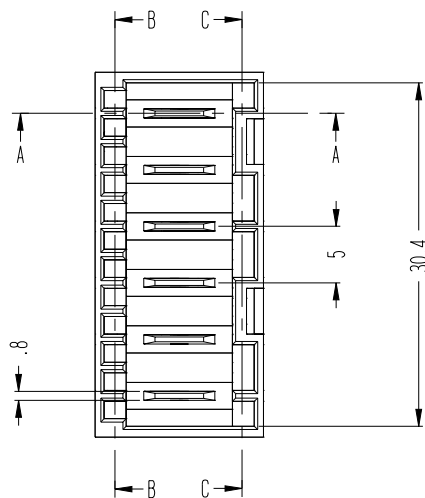

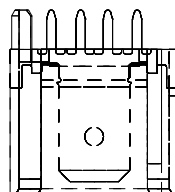
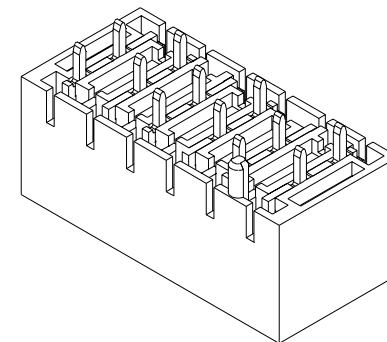
SEZIONE C-C



 COLOMBO SERGIO & Figli S.r.l. 20063 CERNUSCO S/N - VIA COMO, 11 TEL +39.02.9210.7404 - FAX +39.02.9210.0217 <a href="http://www.cscolombo.com">http://www.cscolombo.com</a> - e-mail: info@cscolombo.com			
SCALA 2 : 1	POSIZIONE CAD D:\DIS\CS\P5\PM RAST 5	MATERIALE PA66-V0 FV	
CODICE C.S. CS-R506KnnPCB	INDICE 0 25/03/2003	FORMATO ORIGINALE A 3	RIFERIMENTO 08 - 2003 - 00
			QUOTE SENZA TOLLERANZE 0 - 6 ±0.1 <math>\leq 2^{\circ}</math> > 6 - 30 ±0.2 > 30 ±0.3
			DESCRIZIONE VASCHETTA 6 VIE PM DA SCHEDA P5
INDICE	MODIFICA	DATA	