



Main

| | |
|-------------------------------|---|
| Range of Product | Telemecanique Photoelectric sensors XU |
| Series name | General purpose single mode |
| Electronic sensor type | Photo-electric sensor |
| Sensor name | XUX |
| Sensor design | Compact 92 x 71 |
| Detection system | Reflex |
| Material | Plastic |
| Type of output signal | Discrete |
| Supply circuit type | DC |
| Wiring Technique | 3-wire |
| Discrete output type | PNP |
| Discrete output function | 1 NC |
| Electrical connection | Screw-clamp terminals, 1 x 1.5 mm ² or 1 x 0.75 mm ² with adaptor |
| Product Specific Application | - |
| Emission | Infrared reflex |
| [Sn] nominal sensing distance | 45.93 ft (14 m) reflex need reflector XUZC50 |

Complementary

| | |
|---------------------------|--|
| Enclosure Material | PBT |
| Lens material | PMMA |
| Maximum sensing distance | 65.62 ft (20 m) reflex |
| Output Type | Solid state |
| Cable entry | 1 entry for M16 x 1.5 cable gland 0.28...0.39 in (7...10 mm) |
| Status LED | 1 LED yellow)output state 1 LED green)supply |
| [Us] rated supply voltage | 12...24 V DC |
| Switching capacity in mA | <= 100 mA (overload and short-circuit protection) |
| Switching frequency | <= 250 Hz |
| Maximum voltage drop | <1.5 V (closed state) |
| Current consumption | <= 35 mA (no-load) |
| Maximum delay first up | 15 ms |
| Maximum delay response | 2 ms |
| Maximum delay recovery | 2 ms |
| Setting-up | Sensitivity adjustment |
| Depth | 3.03 in (77 mm) |
| Height | 3.62 in (92 mm) |
| Width | 1.22 in (31 mm) |
| Net Weight | 0.44 lb(US) (0.2 kg) |

The information provided in this documentation contains general descriptions and/or technical characteristics of the performance of the products contained herein. This documentation is not intended as a substitute for and is not to be used for determining suitability or reliability of these products for specific user applications. It is the duty of any such user or integrator to perform the appropriate and complete risk analysis, evaluation and testing of the products with respect to the relevant specific application or use thereof. Neither Schneider Electric Industries SAS nor any of its affiliates or subsidiaries shall be responsible or liable for misuse of the information contained herein.

Environment

| | |
|---------------------------------------|--|
| Product Certifications | UL CE CSA |
| Ambient air temperature for operation | -13...131 °F (-25...55 °C) |
| Ambient Air Temperature for Storage | -40...158 °F (-40...70 °C) |
| Vibration resistance | 7 gn +/- 1.5 mm 10...55 Hz) IEC 60068-2-6 |
| Shock resistance | 30 gn 11 ms) IEC 60068-2-27 |
| IP degree of protection | IP67 double insulation IEC 60529 IP65 double insulation IEC 60529 |





Ordering and shipping details

| | |
|-----------------------|------------------------------|
| Category | 22481-SENSORS, PHOTOELECTRIC |
| Discount Schedule | DS2 |
| GTIN | 3389110168402 |
| Nbr. of units in pkg. | 1 |
| Package weight(Lbs) | 6.70 oz (190.0 g) |
| Returnability | No |
| Country of origin | FR |

Packing Units

| | |
|------------------------------|------------------------|
| Unit Type of Package 1 | PCE |
| Package 1 Height | 1.65 in (4.2 cm) |
| Package 1 width | 3.78 in (9.6 cm) |
| Package 1 Length | 5.20 in (13.2 cm) |
| Unit Type of Package 2 | S01 |
| Number of Units in Package 2 | 11 |
| Package 2 Weight | 5.10 lb(US) (2.314 kg) |
| Package 2 Height | 5.91 in (15 cm) |
| Package 2 width | 5.91 in (15 cm) |
| Package 2 Length | 15.75 in (40 cm) |

Offer Sustainability

| | |
|----------------------------|---|
| Sustainable offer status | Green Premium product |
| California proposition 65 | WARNING: This product can expose you to chemicals including: Diisononyl phthalate (DINP), which is known to the State of California to cause cancer, and Di-isodecyl phthalate (DIDP), which is known to the State of California to cause birth defects or other reproductive harm. For more information go to www.P65Warnings.ca.gov |
| REACH Regulation |  REACH Declaration |
| EU RoHS Directive | Pro-active compliance (Product out of EU RoHS legal scope)  EU RoHS Declaration |
| Mercury free | Yes |
| RoHS exemption information |  Yes |
| Environmental Disclosure |  Product Environmental Profile |
| Circularity Profile |  End Of Life Information |

Contractual warranty

| | |
|----------|-----------|
| Warranty | 18 months |
|----------|-----------|

Dimensions

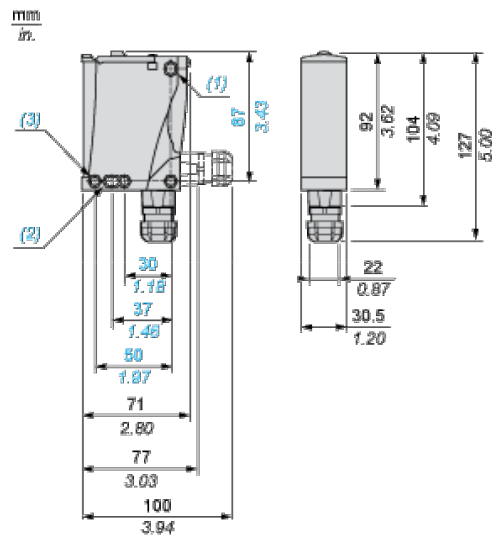

- (1) Elongated hole \varnothing 5.5 x 7
- (2) Elongated hole \varnothing 5.5 x 9
- (3) \varnothing 5.5 hole

Wiring Schemes

PNP/NPN DC

| M12 | | Terminals | | |
|-----|---|-----------|---|--------|
| 1 | ● | 1 | ⊘ | + |
| 3 | ● | 2 | ⊘ | - |
| 4 | ● | 3 | ⊘ | Output |

Detection Curves

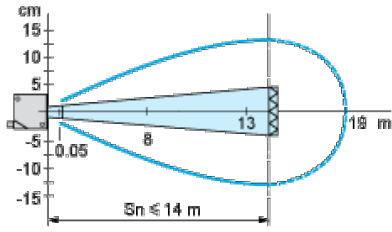

With reflector XUZY50