

# BUK1M200-50SDLD

Quad channel TOPFET™

Rev. 01 — 02 April 2003

Product data

## 1. Product profile

### 1.1 Description

Quad temperature and overload protected logic level power MOSFET in TOPFET™ technology in a 20-pin surface mount plastic package.

Product availability:

BUK1M200-50SDLD in SOT163-1 (SO20).

### 1.2 Features

- Power TrenchMOS™
- Overtemperature protection
- Overload protection
- Input-source voltage resets latched protection circuitry.
- Input used to control output stage and supply overload protection circuits
- 5 V logic compatible input level
- Current limiting
- ESD protection for all pins
- Overfatigue clamping for turn off of inductive loads
- Low operating input current permits direct drive by micro-controller.

### 1.3 Applications

- Low-side driver
- Low frequency Pulse Width Modulation
- DC switching
- General purpose switch for driving lamps, motors, solenoids and heaters.

### 1.4 Quick reference data

Table 1: Quick reference data

Symbol	Parameter	Min	Max	Unit
$R_{DSon}$	drain-source on-state resistance	-	200	mΩ
$P_{tot}$	total power dissipation	[1]	9.4	W
$T_j$	junction temperature	-	150	°C
$V_{DS}$	drain-source voltage	-	50	V

[1] All devices active



PHILIPS

## 2. Pinning information

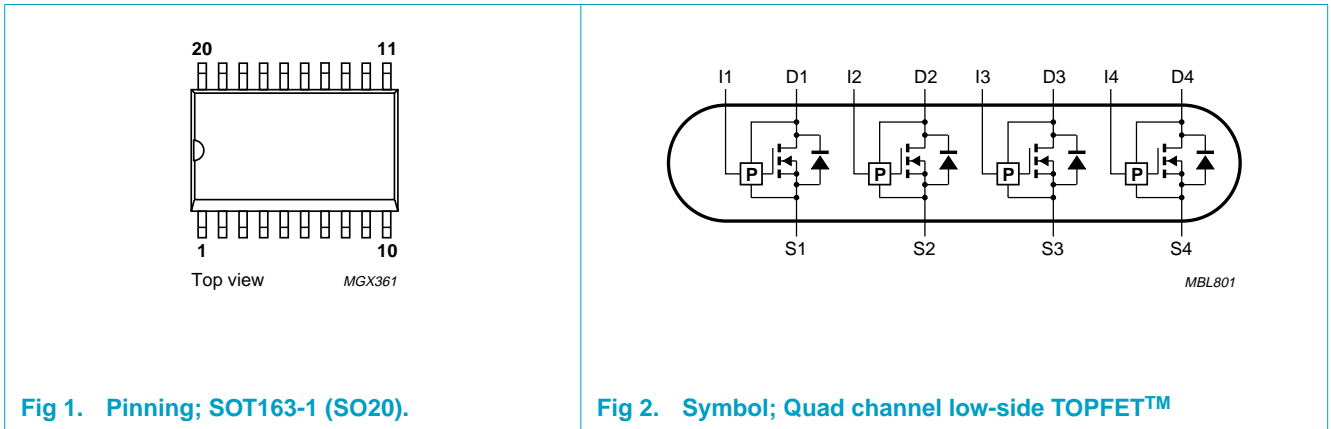


Fig 1. Pinning; SOT163-1 (SO20).

Fig 2. Symbol; Quad channel low-side TOPFET™

### 2.1 Pin description

Table 2: Pin description

Symbol	Pin	Description
n.c.	1, 11, 10, 20	not connected
D1	2,19	drain 1
I1	3	input 1
D2	4,17	drain 2
I2	5	input 2
D3	6,15	drain 3
I3	7	input 3
D4	8, 13	drain 4
I4	9	input 4
S4	12	source 4
S3	14	source 3
S2	16	source 2
S1	18	source 1

### 3. Block diagram

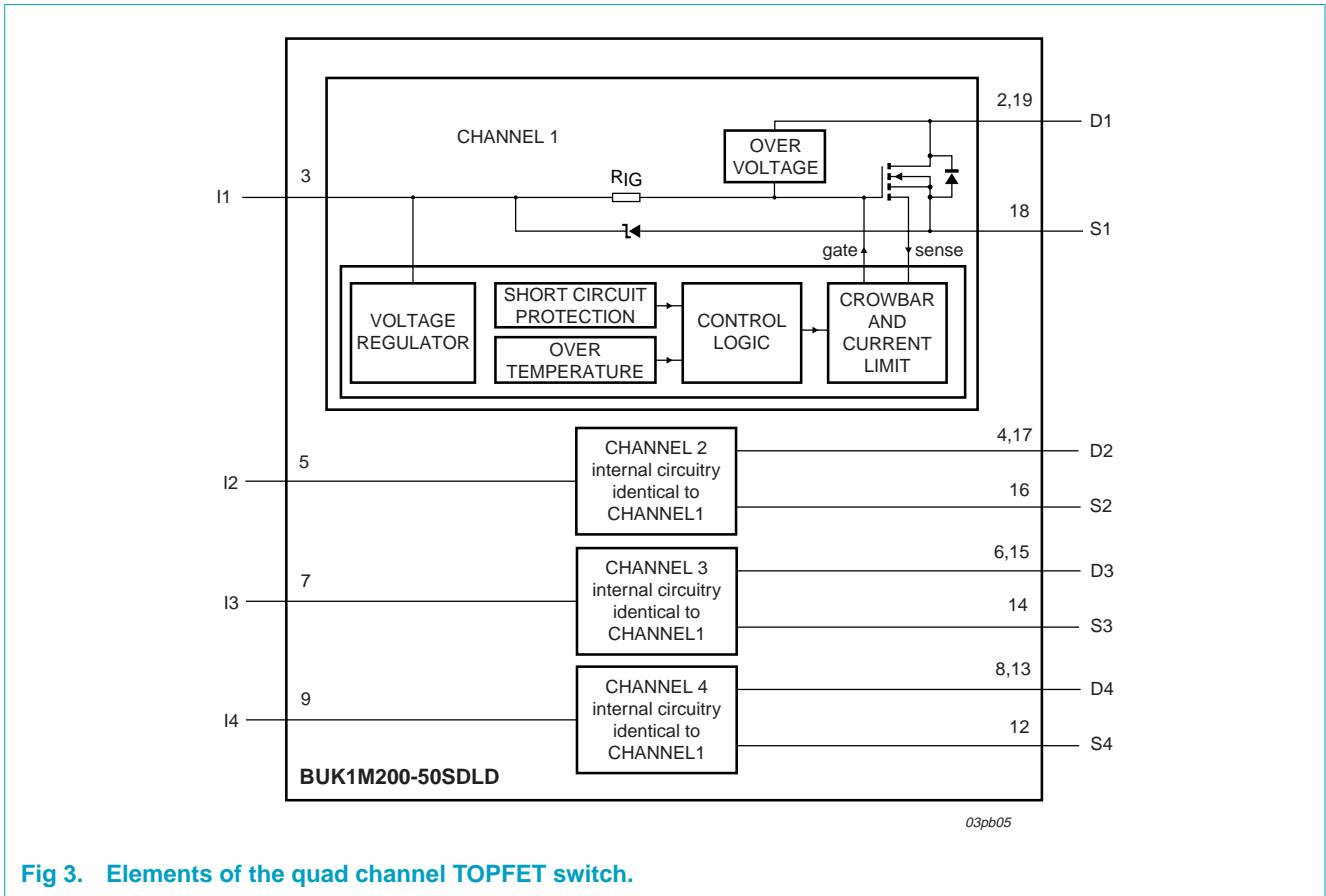


Fig 3. Elements of the quad channel TOPFET switch.

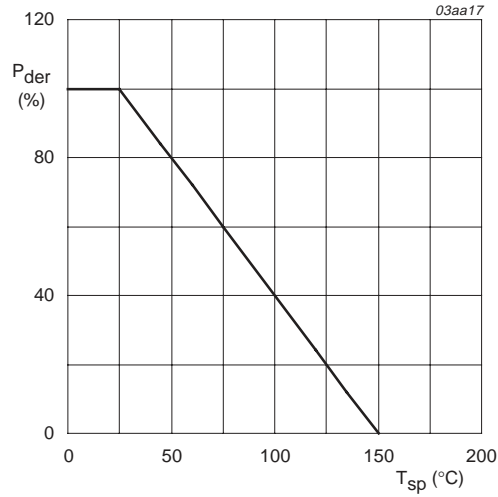
## 4. Limiting values

**Table 3: Limiting values**

In accordance with the Absolute Maximum Rating System (IEC 60134).

Symbol	Parameter	Conditions	Min	Max	Unit
$V_{DS}$	drain-source voltage		[1] -	50	V
$I_I$	input current	clamping	-	3	mA
$P_{tot}$	total power dissipation	$T_{sp} \leq 25\text{ °C}$ ; <b>Figure 4</b>	[2] -	9.4	W
$I_{IMS}$	non-repetitive peak input current	$t_p \leq 1\text{ ms}$	-	10	mA
$T_{stg}$	storage temperature		-55	+150	°C
$T_j$	junction temperature	normal operation	[3] -	150	°C
<b>Overvoltage clamping [4]</b>					
$E_{DS(CL)S}$	non-repetitive drain-source clamping energy	$T_{amb} = 25\text{ °C}$ ; $I_{DM} \leq I_{D(lim)}$ (refer to <b>Table 5</b> ); inductive load	[5] -	100	mJ
$E_{DS(CL)R}$	repetitive drain-source clamping energy	$T_{sp} \leq 125\text{ °C}$ ; $I_{DM} = 50\text{ mA}$ ; $f = 250\text{ Hz}$	[5] -	5	mJ
<b>Overload protection [6]</b>					
$V_{DS(prot)}$	protected drain-source voltage	$V_{IS} \geq 4\text{ V}$	-	35	V
<b>Reverse diode</b>					
$I_S$	source (diode forward) current	$T_{sp} \leq 25\text{ °C}$ ; $V_{IS} = 0\text{ V}$	-	2	A
<b>Electrostatic discharge</b>					
$V_{esd}$	electrostatic discharge voltage	$C = 250\text{ pF}$ ; $R = 1.5\text{ k}\Omega$	-	2	kV

- [1] Prior to the onset of overvoltage clamping. For voltages above this value, safe operation is limited by the overvoltage clamping energy.
- [2] For all devices active.
- [3] Not in an overload condition with drain current limiting.
- [4] At a drain-source voltage above 50 V the power MOSFET is actively turned on to clamp overvoltage transients.
- [5] Single active device.
- [6] With the protection supply provided via the input pin, the TOPFET is protected from short circuit loads. Overload protection operates by means of drain current limiting and by activating the overtemperature protection.



$$P_{der} = \frac{P_{tot}}{P_{tot(25^{\circ}C)}} \times 100\%$$

Fig 4. Normalized total power dissipation as a function of solder point temperature.

## 5. Thermal characteristics

Table 4: Thermal characteristics

Symbol	Parameter	Conditions	Min	Typ	Max	Unit
R <sub>th(j-sp)</sub>	thermal resistance from junction to solder point.	mounted on thermo clad board				
		one device active	-	-	45	K/W
		all devices active	-	-	13.3	K/W

## 6. Static characteristics

**Table 5: Static characteristics**

Limits are valid for  $-40\text{ °C} \leq T_{sp} \leq +150\text{ °C}$  and typical values for  $T_{sp} = 25\text{ °C}$  unless otherwise specified.

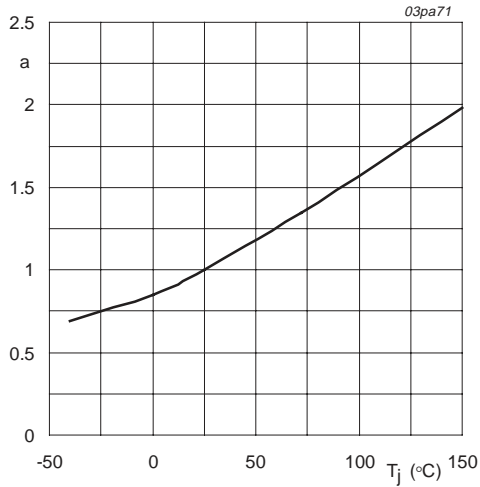
Symbol	Parameter	Conditions	Min	Typ	Max	Unit
<b>Off-state output characteristics</b>						
$V_{DS(CL)}$	drain-source clamping voltage	$V_{IS} = 0\text{ V}; I_D = 10\text{ mA}$	50	-	-	V
		$V_{IS} = 0\text{ V}; I_D = 200\text{ mA}; t_p \leq 300\text{ }\mu\text{s}; \delta \leq 0.01$ ; <a href="#">Figure 16</a>	50	62	70	V
$I_{DSS}$	drain-source leakage current	$V_{IS} = 0\text{ V}; V_{DS} = 40\text{ V}$	-	-	100	$\mu\text{A}$
		$T_{sp} = 25\text{ °C}$ ; <a href="#">Figure 17</a>	-	0.05	10	$\mu\text{A}$
<b>On-state output characteristic</b>						
$R_{DSon}$	drain-source on-state resistance	$V_{IS} \geq 4\text{ V}; t_p \leq 300\text{ }\mu\text{s}; \delta \leq 0.01$ ; $I_D = 100\text{ mA}$ ; <a href="#">Figure 5 and 6</a>	-	-	380	$\text{m}\Omega$
		$T_{sp} = 25\text{ °C}$	-	150	200	$\text{m}\Omega$
<b>Input characteristics <sup>[1]</sup></b>						
$V_{IS(th)}$	input-source threshold voltage	$V_{DS} = 5\text{ V}; I_D = 1\text{ mA}$	0.6	-	2.4	V
		$T_{sp} = 25\text{ °C}$ ; <a href="#">Figure 10</a>	1.1	1.6	2.1	V
$I_{IS}$	input-source current	normal operation				
		$V_{IS} = 5\text{ V}$	100	220	400	$\mu\text{A}$
		$V_{IS} = 4\text{ V}$	80	195	330	$\mu\text{A}$
		protection latched				
		$V_{IS} = 5\text{ V}$	200	400	650	$\mu\text{A}$
$V_{IS} = 3\text{ V}$ ; <a href="#">Figure 11 and 12</a>	130	250	430	$\mu\text{A}$		
$V_{IS(rst)}$	input-source reset voltage	$t_{rst} \geq 100\text{ }\mu\text{s}$ ; <a href="#">Figure 15</a>	<sup>[2]</sup> 1.5	2	2.9	V
$t_{rst(latch)}$	latch reset time		<sup>[6]</sup> 10	40	100	$\mu\text{s}$
$V_{IS(CL)}$	input-source clamping voltage	$I_I = 1.5\text{ mA}$ ; <a href="#">Figure 16</a>	5.5	-	8.5	V
$R_{IG}$	input-gate resistance		<sup>[3]</sup> -	33	-	$\text{k}\Omega$
<b>Overload protection characteristic <sup>[4]</sup></b>						
$I_{D(lim)}$	drain current limiting	$V_{IS} = 5\text{ V}$ ; <a href="#">Figure 18</a>	0.8	1.3	1.7	A
		$V_{IS} = 4.5\text{ V}$	0.7	-	-	A
		$4\text{ V} \leq V_{IS} \leq 5.5\text{ V}$ ;	0.6	-	1.8	A
<b>Short circuit load protection characteristics</b>						
$P_{OV(th)}$	overload power threshold	$V_{IS} = 5\text{ V}$	<sup>[5]</sup> -	17	-	W
$T_{d(sc)}$	short circuit response time	$V_{IS} = 5\text{ V}$ ; <a href="#">Figure 14</a>	<sup>[7]</sup> -	1.6	-	ms
<b>Overtemperature protection characteristic</b>						
$T_{j(th)}$	threshold junction temperature	$4\text{ V} \leq V_{IS} \leq 5.5\text{ V}; I_D \geq 280\text{ mA}$ or $V_{DS} \geq 100\text{ mV}$ ; <a href="#">Figure 9</a>	150	165	-	$^{\circ}\text{C}$
<b>Source-drain diode characteristic</b>						
$V_{SD}$	source-drain (diode forward) voltage	$I_S = 2\text{ A}; V_{IS} = 0\text{ V}; t_p = 300\text{ }\mu\text{s}$	-	0.83	1.1	V

[1] The supply for the logic and overload protection is taken from the input.

[2] The input voltage below which the overload protection circuits will be reset.

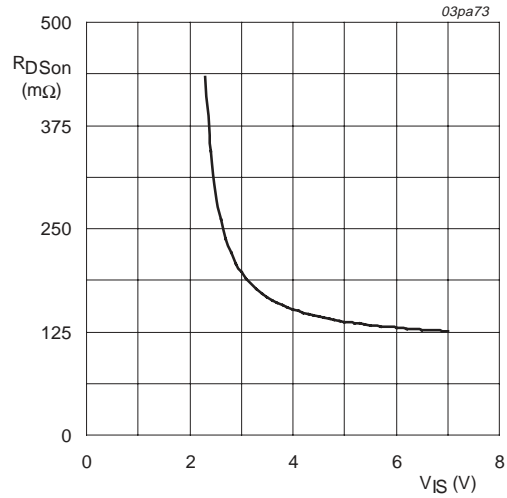
[3] Not directly measurable from the device terminals.

- [4] The TOPFET switches off to protect itself when one of the overload thresholds is exceeded. It remains latched off until reset by the input.
- [5] Power threshold for protection to operate.
- [6] To reset the latched state, the input-source voltage is reduced from 5 V to 1 V.
- [7] Trip time  $t_{(trip)}$  varies with overload dissipation  $P_{OV}$  according to the formula  $t_{(trip)} = t_{d(sc)} / [P_{OV} / P_{OV(th)} - 1]$



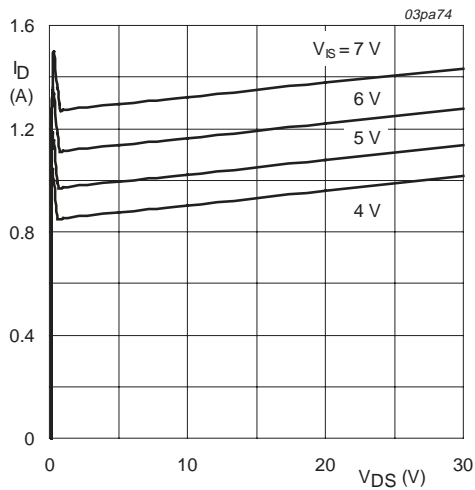
$$a = \frac{R_{DSon}}{R_{DSon(25^{\circ}C)}}$$

**Fig 5. Normalized drain-source on-state resistance factor as a function of junction temperature.**



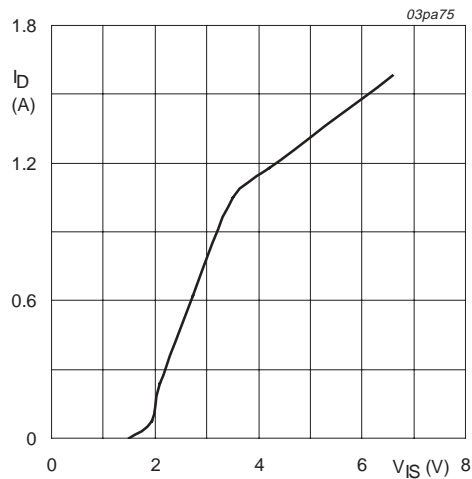
$T_j = 25^{\circ}C; I_D = 100\text{ mA}; t_p = 300\ \mu s$

**Fig 6. Drain-source on-state resistance as a function of input-source voltage; typical values.**



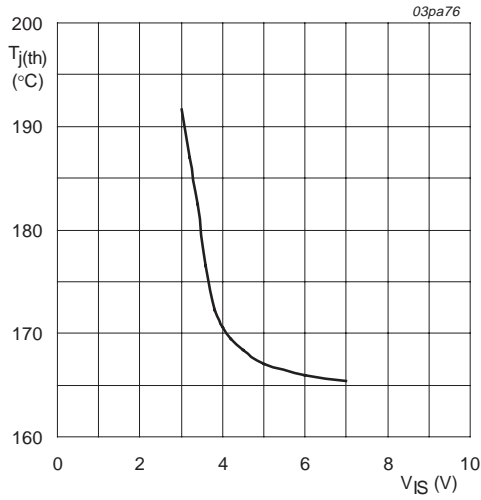
$T_j = 25^{\circ}C; t_p = 300\ \mu s$

**Fig 7. Output characteristics; drain current as a function of drain-source voltage; typical values.**

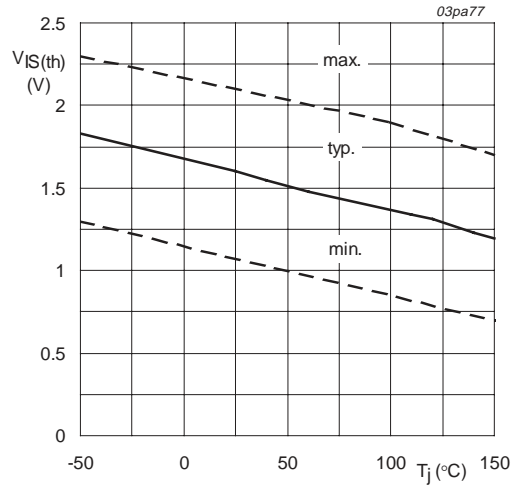


$T_j = 25^{\circ}C; V_{DS} = 10\text{ V}; t_p = 300\ \mu s$

**Fig 8. Transfer characteristics; drain current as a function of input-source voltage; typical values.**

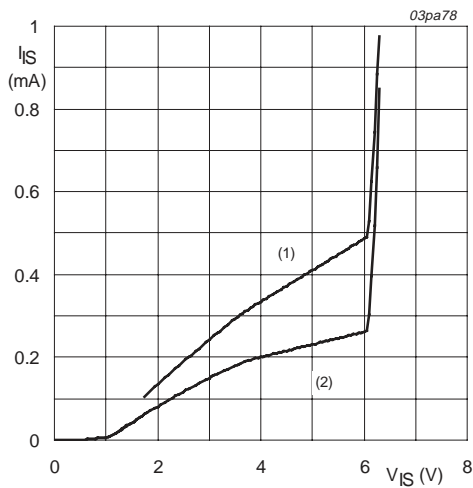


**Fig 9. Overtemperature protection characteristic; threshold junction temperature as a function of input-source voltage; typical values.**



$I_D = \text{mA}; V_{DS} = 5 \text{ V}$

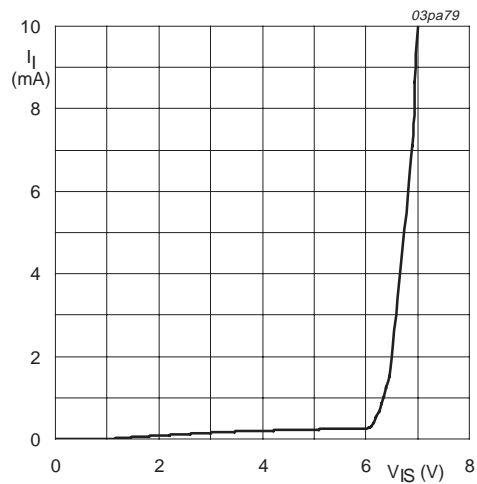
**Fig 10. Input-source threshold voltage as a function of junction temperature.**



$T_j = 25 \text{ °C}$

- (1) Protection latched.
- (2) Normal operation.

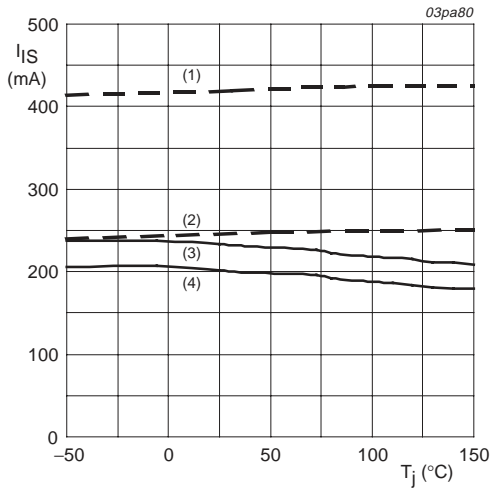
**Fig 11. Input-source current as a function of input-source voltage; typical values.**



$T_j = 25 \text{ °C}$

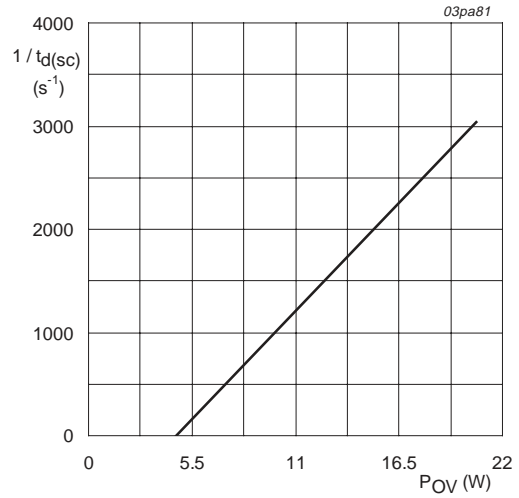
**Fig 12. Input clamping characteristic; input current as a function of input-source voltage; typical values.**





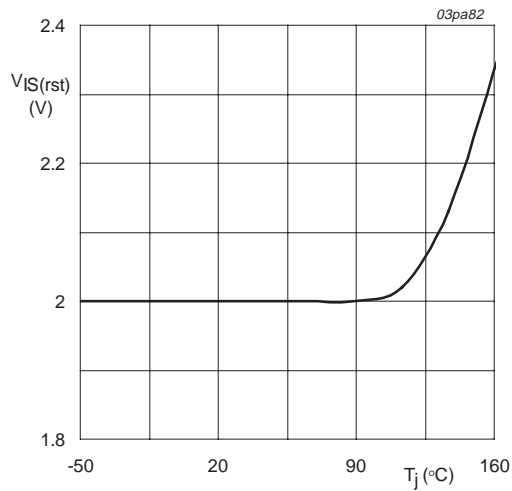
- (1)  $V_{IS} = 5\text{ V}$ ; device in latched mode.
- (2)  $V_{IS} = 3\text{ V}$ ; device in latched mode.
- (3)  $V_{IS} = 5\text{ V}$ ; device in normal mode.
- (4)  $V_{IS} = 4\text{ V}$ ; device in normal mode.

**Fig 13. Input-source current as a function of junction temperature; typical values.**



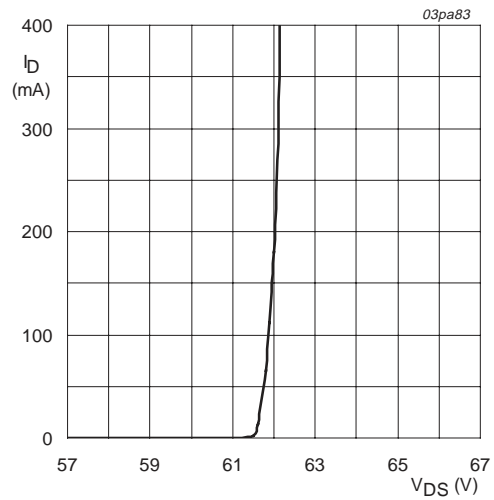
$V_{IS} \geq 4\text{ V}$ ;  $T_j \leq 125\text{ °C}$

**Fig 14. Reciprocal of short circuit response time as a function of total overload power; single device dissipating; typical values**



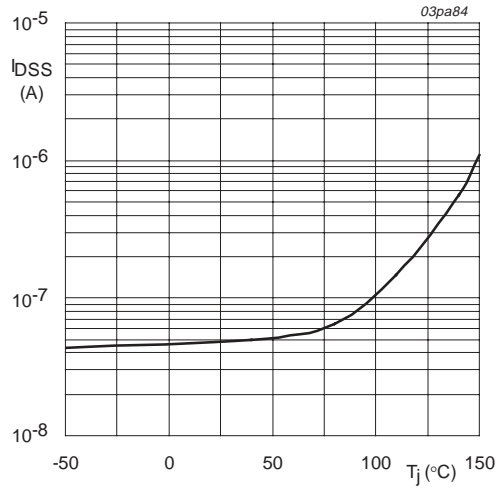
$t_r = 100\text{ }\mu\text{s}$

**Fig 15. Input-source reset voltage as a function of junction temperature; typical values.**



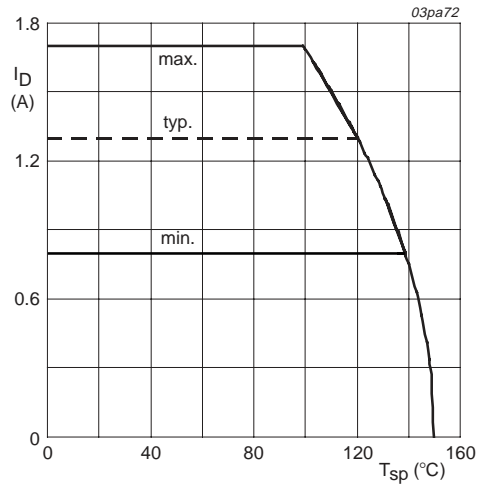
$V_{IS} = 0\text{ V}$ ;  $t_p = 300\text{ }\mu\text{s}$

**Fig 16. Overage clamping characteristic; drain current as a function of drain-source voltage; typical values.**



$V_{DS} = 40\text{ V}; V_{IS} = 0\text{ V}$

**Fig 17.** Drain-source leakage current as a function of junction temperature; typical values.



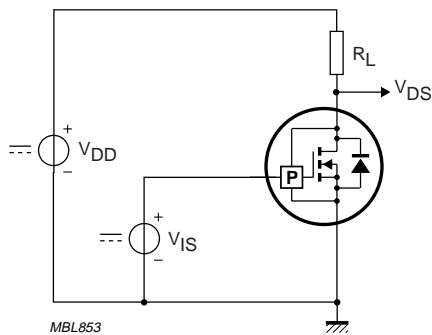
$V_{IS} = 5\text{ V}$

**Fig 18.** Drain current limiting as a function of solder point temperature.

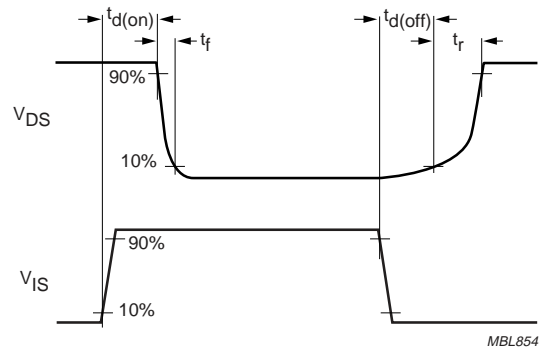
## 7. Dynamic characteristics

**Table 6:** Switching characteristics

Symbol	Parameter	Conditions	Min	Typ	Max	Unit
<b>Turn-on measured from the input going HIGH</b>						
$t_{d(on)}$	turn-on delay time	$R_L = 50\ \Omega; I_D = 250\text{ mA}; V_{IS} = 5\text{ V};$ <b>Figure 19 and 20; <math>T_{sp} = 25\text{ }^\circ\text{C}</math></b>	-	5	12	$\mu\text{s}$
$t_r$	rise time		-	11	30	$\mu\text{s}$
$t_{d(off)}$	turn-off delay time		-	25	65	$\mu\text{s}$
$t_f$	fall time		-	14	35	$\mu\text{s}$



**Fig 19.** Test circuit for resistive load switching times.



**Fig 20.** Resistive load switching waveforms.

**8. Package outline**

SO20: plastic small outline package; 20 leads; body width 7.5 mm

SOT163-1

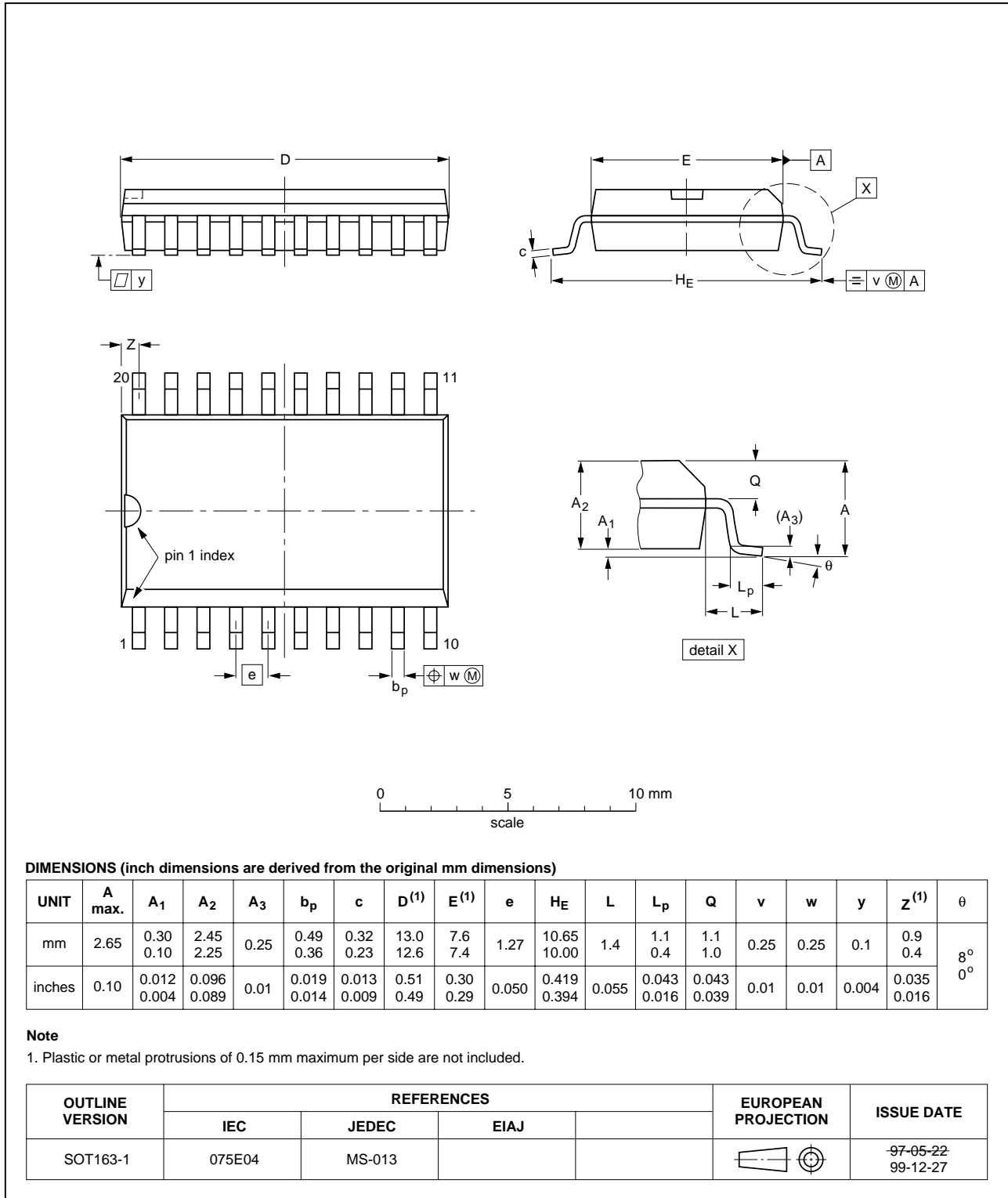


Fig 21. SOT163-1.

## 9. Revision history

---

Table 7: Revision history

Rev	Date	CPCN	Description
01	20030402	-	Product datasheet (9397 750 10956)

## 10. Data sheet status

Level	Data sheet status <sup>[1]</sup>	Product status <sup>[2][3]</sup>	Definition
I	Objective data	Development	This data sheet contains data from the objective specification for product development. Philips Semiconductors reserves the right to change the specification in any manner without notice.
II	Preliminary data	Qualification	This data sheet contains data from the preliminary specification. Supplementary data will be published at a later date. Philips Semiconductors reserves the right to change the specification without notice, in order to improve the design and supply the best possible product.
III	Product data	Production	This data sheet contains data from the product specification. Philips Semiconductors reserves the right to make changes at any time in order to improve the design, manufacturing and supply. Relevant changes will be communicated via a Customer Product/Process Change Notification (CPCN).

[1] Please consult the most recently issued data sheet before initiating or completing a design.

[2] The product status of the device(s) described in this data sheet may have changed since this data sheet was published. The latest information is available on the Internet at URL <http://www.semiconductors.philips.com>.

[3] For data sheets describing multiple type numbers, the highest-level product status determines the data sheet status.

## 11. Definitions

**Short-form specification** — The data in a short-form specification is extracted from a full data sheet with the same type number and title. For detailed information see the relevant data sheet or data handbook.

**Limiting values definition** — Limiting values given are in accordance with the Absolute Maximum Rating System (IEC 60134). Stress above one or more of the limiting values may cause permanent damage to the device. These are stress ratings only and operation of the device at these or at any other conditions above those given in the Characteristics sections of the specification is not implied. Exposure to limiting values for extended periods may affect device reliability.

**Application information** — Applications that are described herein for any of these products are for illustrative purposes only. Philips Semiconductors make no representation or warranty that such applications will be suitable for the specified use without further testing or modification.

## 12. Disclaimers

**Life support** — These products are not designed for use in life support appliances, devices, or systems where malfunction of these products can reasonably be expected to result in personal injury. Philips Semiconductors

customers using or selling these products for use in such applications do so at their own risk and agree to fully indemnify Philips Semiconductors for any damages resulting from such application.

**Right to make changes** — Philips Semiconductors reserves the right to make changes in the products - including circuits, standard cells, and/or software - described or contained herein in order to improve design and/or performance. When the product is in full production (status 'Production'), relevant changes will be communicated via a Customer Product/Process Change Notification (CPCN). Philips Semiconductors assumes no responsibility or liability for the use of any of these products, conveys no licence or title under any patent, copyright, or mask work right to these products, and makes no representations or warranties that these products are free from patent, copyright, or mask work right infringement, unless otherwise specified.

## 13. Trademarks

**TOPFET** — is a trademark of Koninklijke Philips Electronics N.V.

**TrenchMOS** — is a trademark of Koninklijke Philips Electronics N.V.

## Contact information

For additional information, please visit <http://www.semiconductors.philips.com>.

For sales office addresses, send e-mail to: [sales.addresses@www.semiconductors.philips.com](mailto:sales.addresses@www.semiconductors.philips.com).

Fax: +31 40 27 24825

## Contents

<b>1</b>	<b>Product profile</b> .....	<b>1</b>
1.1	Description .....	1
1.2	Features .....	1
1.3	Applications .....	1
1.4	Quick reference data .....	1
<b>2</b>	<b>Pinning information</b> .....	<b>2</b>
2.1	Pin description .....	2
<b>3</b>	<b>Block diagram</b> .....	<b>3</b>
<b>4</b>	<b>Limiting values</b> .....	<b>4</b>
<b>5</b>	<b>Thermal characteristics</b> .....	<b>5</b>
<b>6</b>	<b>Static characteristics</b> .....	<b>6</b>
<b>7</b>	<b>Dynamic characteristics</b> .....	<b>10</b>
<b>8</b>	<b>Package outline</b> .....	<b>11</b>
<b>9</b>	<b>Revision history</b> .....	<b>12</b>
<b>10</b>	<b>Data sheet status</b> .....	<b>13</b>
<b>11</b>	<b>Definitions</b> .....	<b>13</b>
<b>12</b>	<b>Disclaimers</b> .....	<b>13</b>
<b>13</b>	<b>Trademarks</b> .....	<b>13</b>

© Koninklijke Philips Electronics N.V. 2003.  
Printed in The Netherlands

All rights are reserved. Reproduction in whole or in part is prohibited without the prior written consent of the copyright owner.

The information presented in this document does not form part of any quotation or contract, is believed to be accurate and reliable and may be changed without notice. No liability will be accepted by the publisher for any consequence of its use. Publication thereof does not convey nor imply any license under patent- or other industrial or intellectual property rights.

Date of release: 02 April 2003

Document order number: 9397 750 10956



# PHILIPS

*Let's make things better.*