

521282-1 ✓ ACTIVE

Ultra-Pod | Ultra-Pod 250

TE Internal #: 521282-1

Quick Disconnects, Receptacle, 18 – 14 AWG Wire Size, .82 – 2.08 mm² Wire Size, Mating Tab Width 6.35 mm [.25 in], Flag, Brass, Ultra-Pod 250

[View on TE.com >](#)



Terminals & Splices > Quick Disconnects



Quick Disconnect Terminal Type: **Receptacle**

Wire Size: **.82 – 2.08 mm²**

Mating Tab Width: **6.35 mm [.25 in]**

Mating Tab Thickness: **.81 mm [.032 in]**

Features

Product Type Features

Insertion Force	Low
-----------------	-----

Configuration Features

Connection Capacity	Single
---------------------	--------

Compatible With Wire & Cable Type	Discrete Wire
-----------------------------------	---------------

Electrical Characteristics

Voltage Rating	600 V
----------------	-------

Body Features

Insulation Material	Nylon
---------------------	-------

Contact Features

Quick Disconnect Terminal Type	Receptacle
--------------------------------	------------

Mating Tab Width	6.35 mm [.25 in]
------------------	------------------

Mating Tab Thickness	.81 mm [.032 in]
----------------------	------------------

Terminal Orientation	Flag
----------------------	------

Contact Base Material	Brass
-----------------------	-------



Terminal Plating Material	Unplated
---------------------------	----------

Crimp Type	Tab-Lok
------------	---------

Barrel Type	Open
-------------	------

Termination Features

Product Terminates To	Wire & Cable
-----------------------	--------------

Mechanical Attachment

Wire Insulation Support	With
-------------------------	------

Dimensions

Terminal Material Thickness	.41 mm[.016 in]
-----------------------------	-----------------

Product Length	22.99 mm[.905 in]
----------------	-------------------

Compatible Insulation Diameter Range	2.79 – 4.06 mm[.11 – .16 in]
--------------------------------------	------------------------------

Wire Size	.82 – 2.08 mm ²
-----------	----------------------------

Usage Conditions

Insulation Option	Fully Insulated
-------------------	-----------------

Operating Temperature Range	-40 – 150 °C[-40 – 302 °F]
-----------------------------	----------------------------

Industry Standards

Agency/Standard	CSA, UL
-----------------	---------

Approved Standards	UL E66717
--------------------	-----------

UL Flammability Rating	UL 94V-0
------------------------	----------

Packaging Features

Packaging Quantity	1800
--------------------	------

Packaging Method	Strip/Reel
------------------	------------

Other

Barrel Color	Natural
--------------	---------

Product Compliance

[For compliance documentation, visit the product page on TE.com>](#)

EU RoHS Directive 2011/65/EU	Compliant
------------------------------	-----------

EU ELV Directive 2000/53/EC	Compliant
-----------------------------	-----------

China RoHS 2 Directive MIIT Order No 32, 2016	No Restricted Materials Above Threshold
---	---

EU REACH Regulation (EC) No. 1907/2006	Current ECHA Candidate List: JUNE 2023 (235)
--	--

Candidate List Declared Against: JAN 2023
(233)

Does not contain REACH SVHC

Halogen Content

Low Halogen - Br, Cl, F, I < 900 ppm per homogenous material. Also BFR/CFR/PVC Free







Solder Process Capability

Not applicable for solder process capability

Product Compliance Disclaimer

This information is provided based on reasonable inquiry of our suppliers and represents our current actual knowledge based on the information they provided. This information is subject to change. The part numbers that TE has identified as EU RoHS compliant have a maximum concentration of 0.1% by weight in homogenous materials for lead, hexavalent chromium, mercury, PBB, PBDE, DBP, BBP, DEHP, DIBP, and 0.01% for cadmium, or qualify for an exemption to these limits as defined in the Annexes of Directive 2011/65/EU (RoHS2). Finished electrical and electronic equipment products will be CE marked as required by Directive 2011/65/EU. Components may not be CE marked. Additionally, the part numbers that TE has identified as EU ELV compliant have a maximum concentration of 0.1% by weight in homogenous materials for lead, hexavalent chromium, and mercury, and 0.01% for cadmium, or qualify for an exemption to these limits as defined in the Annexes of Directive 2000/53/EC (ELV). Regarding the REACH Regulation, the information TE provides on SVHC in articles for this part number is based on the latest European Chemicals Agency (ECHA) 'Guidance on requirements for substances in articles' posted at this URL: <https://echa.europa.eu/guidance-documents/guidance-on-reach>

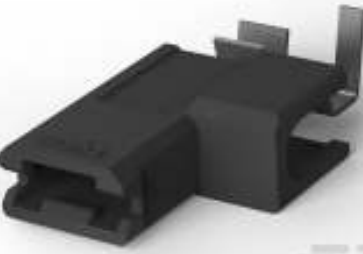
Compatible Parts

 <p>TE Part # CAT-UL8-25021 ULTRA POD: Flag, Receptacle Assembly, Tin Plated, .250 inch</p>	 <p>TE Part # 521411-1 ULTRA-POD 250 ASY REC 22-18 AWG BR</p>	 <p>TE Part # 1969109-1 ULTRA-POD 250 ASSY REC 18-14 AWG BR</p>	 <p>TE Part # 1852892-1 MACH,U-POD FLAG EAPR110F1800 AOM/CLS</p>
 <p>TE Part # 1852892-3 MACH,U-POD FLAG EAPR110F1800 BENCH G</p>	 <p>TE Part # 1852892-7 MACH,U-POD FLAG EAPR110F1800 KOMAX</p>	 <p>TE Part # 521087-1 ULTRA-POD 250 ASSY REC 18-14 AWG NPST</p>	 <p>TE Part # 1852892-2 MACH,U-POD FLAG EAPR110F1800 BENCH K</p>

Also in the Series | [Ultra-Pod 250](#)



Insertion & Extraction Tools(2)



Quick Disconnects(43)

Customers Also Bought



TE Part #520963-1
ULTRA POD: Straight, Receptacle
Assembly, Unplated, .250 inch



TE Part #521597-2
ULTRA POD: Flag, Receptacle
Assembly, Tin Plated, .187 inch



TE Part #42486-2
187 FASTON FLAG REC 20-16 AWG
TPBR



TE Part #520971-1
ULTRA-POD 250 ASY REC 18-14 AWG
BR

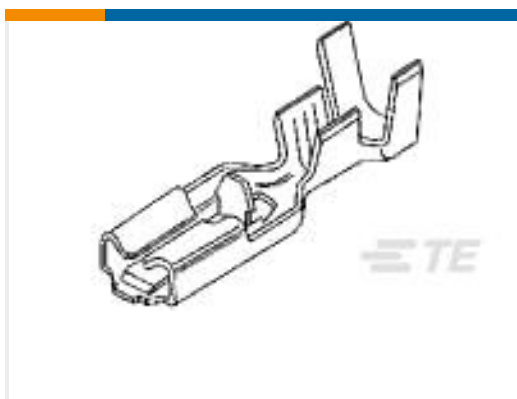

TE Part #63097-2
POSITIVE LOCK 250 REC 18-14 AWG
BR



TE Part #1-2232892-9
9P MONOPLUG 2.5



TE Part #7-1633962-4
CRIMPER, INSULATION F PREMIUM



TE Part #2232900-6
ECONOMY POWER TPA RETAINER

Documents

Product Drawings

[ULTRA-POD 250 ASS REC 18-14 AWG BR LIF](#)

English

CAD Files

[3D PDF](#)

3D

Customer View Model

[ENG_CVM_CVM_521282-1_C.2d_dxf.zip](#)

English

Customer View Model

[ENG_CVM_CVM_521282-1_C.3d_igs.zip](#)

English

Customer View Model

[ENG_CVM_CVM_521282-1_C.3d_stp.zip](#)

English

By downloading the CAD file I accept and agree to the [Terms and Conditions](#) of use.



Datasheets & Catalog Pages

Ultra-Fast and Ultra Fast Plus

English

Product Specifications

Application Specification

English

Product Environmental Compliance

TE Material Declaration

English