

# UT 2,5/1P BU - Feed-through terminal block



3045020

<https://www.phoenixcontact.com/us/products/3045020>

Please be informed that the data shown in this PDF document is generated from our online catalog. Please find the complete data in the user documentation. Our general terms of use for downloads are valid.



Feed-through terminal block, nom. voltage: 500 V, nominal current: 24 A, number of connections: 2, connection method: Screw/plug-in connection, Rated cross section: 2.5 mm<sup>2</sup>, cross section: 0.14 mm<sup>2</sup> - 4 mm<sup>2</sup>, mounting type: NS 35/7,5, NS 35/15, color: blue

## Your advantages

- Terminal blocks that can be connected on both sides available
- Compatible with standard UT terminal blocks
- Uniform, touch-proof plug-in zone

## Commercial data

Item number	3045020
Packing unit	1 pc
Minimum order quantity	50 pc
Sales key	BE01
Product key	BE1141
Catalog page	Page 303 (C-1-2019)
GTIN	4017918975364
Weight per piece (including packing)	7.07 g
Weight per piece (excluding packing)	6.715 g
Customs tariff number	85369010
Country of origin	TR

# UT 2,5/1P BU - Feed-through terminal block



3045020

<https://www.phoenixcontact.com/us/products/3045020>

## Technical data

### Notes

General	Current and voltage are determined by the plug used.
---------	--

### Product properties

Product type	Plug-in terminal block
Number of connections	2
Number of rows	1
Potentials	1

### Insulation characteristics

Overvoltage category	III
Degree of pollution	3

### Electrical properties

Rated surge voltage	6 kV
Maximum power dissipation for nominal condition	0.77 W

### Connection data

Number of connections per level	2
Nominal cross section	2.5 mm <sup>2</sup>
Rated cross section AWG	12

### Level 1 above 1 below 1

Screw thread	M3
Tightening torque	0.5 ... 0.6 Nm
Stripping length	9 mm
Internal cylindrical gage	A3
Connection in acc. with standard	IEC 61984
Conductor cross section rigid	0.14 mm <sup>2</sup> ... 4 mm <sup>2</sup>
Cross section AWG	26 ... 12 (converted acc. to IEC)
Conductor cross section flexible	0.14 mm <sup>2</sup> ... 4 mm <sup>2</sup>
Conductor cross section, flexible [AWG]	26 ... 12 (converted acc. to IEC)
Conductor cross-section flexible (ferrule without plastic sleeve)	0.14 mm <sup>2</sup> ... 2.5 mm <sup>2</sup>
Flexible conductor cross section (ferrule with plastic sleeve)	0.14 mm <sup>2</sup> ... 2.5 mm <sup>2</sup>
2 conductors with same cross section, solid	0.14 mm <sup>2</sup> ... 1.5 mm <sup>2</sup>
2 conductors with same cross section, flexible	0.14 mm <sup>2</sup> ... 1.5 mm <sup>2</sup>
2 conductors with same cross section, flexible, with ferrule without plastic sleeve	0.14 mm <sup>2</sup> ... 1.5 mm <sup>2</sup>
2 conductors with the same cross section, flexible, with TWIN ferrule with plastic sleeve	0.5 mm <sup>2</sup> ... 1.5 mm <sup>2</sup>
Nominal current	24 A
Maximum load current	24 A (with 4 mm <sup>2</sup> conductor cross section)
Nominal voltage	500 V

# UT 2,5/1P BU - Feed-through terminal block

3045020

<https://www.phoenixcontact.com/us/products/3045020>

Nominal cross section	2.5 mm <sup>2</sup>
-----------------------	---------------------

## Dimensions

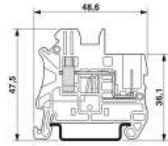
Dimensional drawing	
Width	5.2 mm
End cover width	2.2 mm
Height	49.1 mm
Depth on NS 35/7,5	47.5 mm
Depth on NS 35/15	55 mm

## Material specifications

Color	blue
Flammability rating according to UL 94	V0
Insulating material group	I
Insulating material	PA
Static insulating material application in cold	-60 °C
Temperature index of insulation material (DIN EN 60216-1 (VDE 0304-21))	130 °C
Relative insulation material temperature index (Elec., UL 746 B)	130 °C
Fire protection for rail vehicles (DIN EN 45545-2) R22	HL 1 - HL 3
Fire protection for rail vehicles (DIN EN 45545-2) R23	HL 1 - HL 3
Fire protection for rail vehicles (DIN EN 45545-2) R24	HL 1 - HL 3
Fire protection for rail vehicles (DIN EN 45545-2) R26	HL 1 - HL 3
Calorimetric heat release NFPA 130 (ASTM E 1354)	28 MJ/kg
Surface flammability NFPA 130 (ASTM E 162)	passed
Specific optical density of smoke NFPA 130 (ASTM E 662)	passed
Smoke gas toxicity NFPA 130 (SMP 800C)	passed

## Mechanical properties

### Mechanical data

Open side panel	Yes
-----------------	-----

## Environmental and real-life conditions

### Ambient conditions

Ambient temperature (operation)	-60 °C (max. operating temperature see derating curve)
Ambient temperature (storage/transport)	-25 °C ... 60 °C (for a short time, not exceeding 24 h, -60 °C to +70 °C)
Ambient temperature (assembly)	-5 °C ... 70 °C
Ambient temperature (actuation)	-5 °C ... 70 °C
Permissible humidity (storage/transport)	30 % ... 70 %

# UT 2,5/1P BU - Feed-through terminal block



3045020

<https://www.phoenixcontact.com/us/products/3045020>

## Standards and regulations

Connection in acc. with standard	IEC 61984
----------------------------------	-----------

## Mounting

Mounting type	NS 35/7,5
	NS 35/15

# UT 2,5/1P BU - Feed-through terminal block



3045020

<https://www.phoenixcontact.com/us/products/3045020>

## Drawings

Diagram

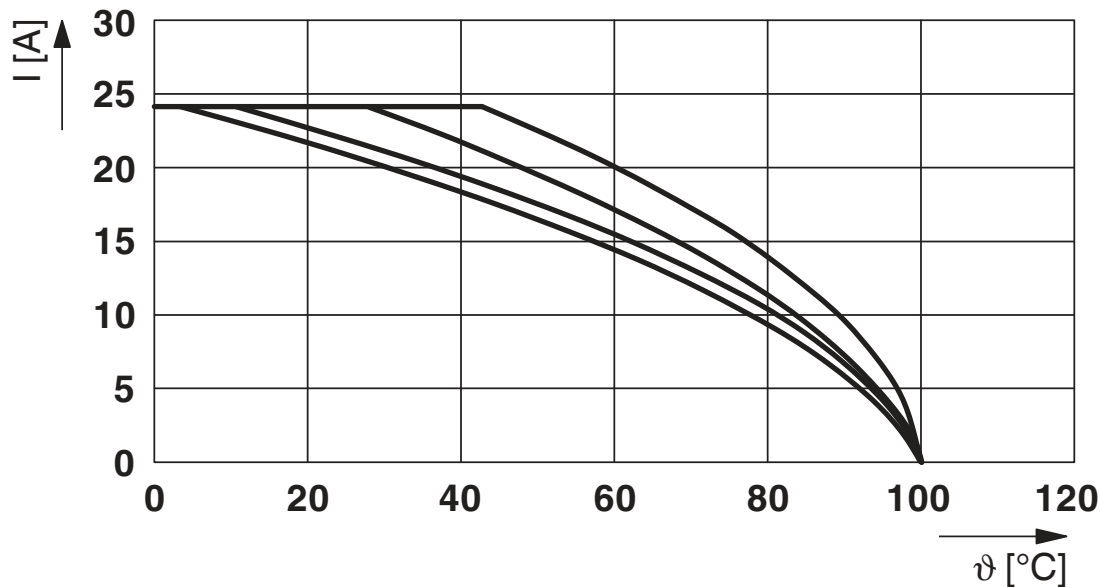

Diagram

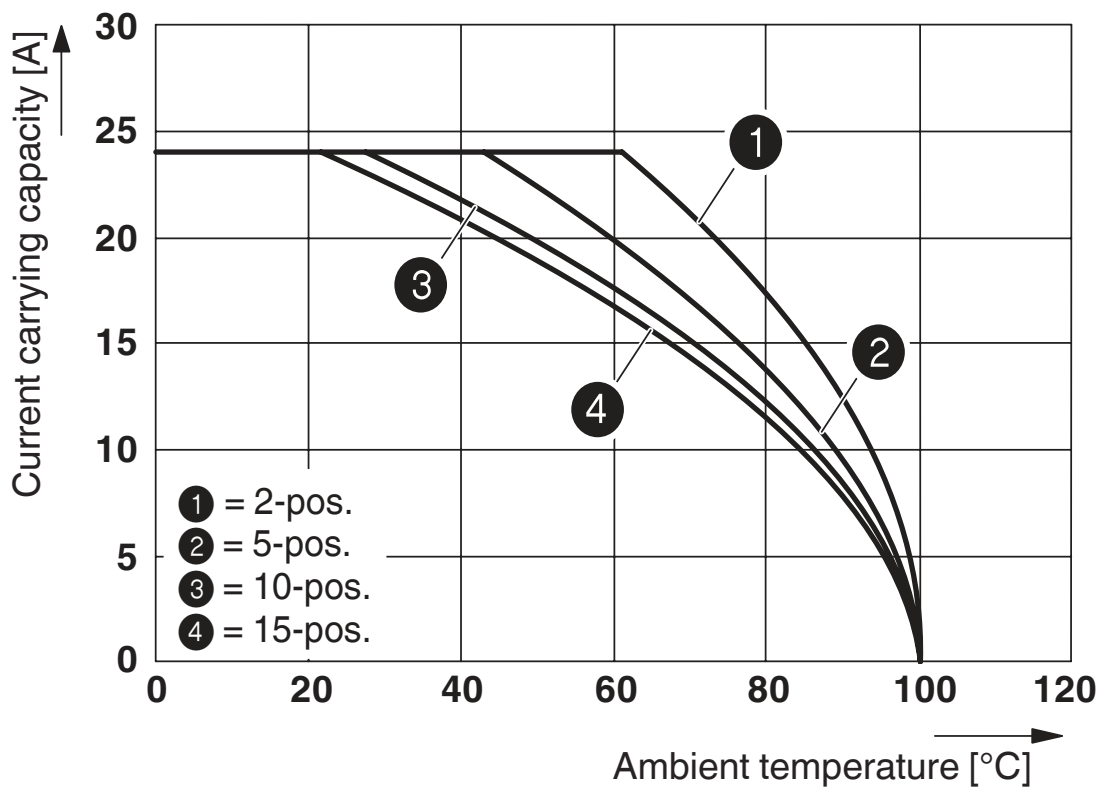

The figure shows the derating curve of the UT 2,5/1P... terminal block in connection with the UPBV 2,5 plug

# UT 2,5/1P BU - Feed-through terminal block

3045020

<https://www.phoenixcontact.com/us/products/3045020>



Dimensional drawing

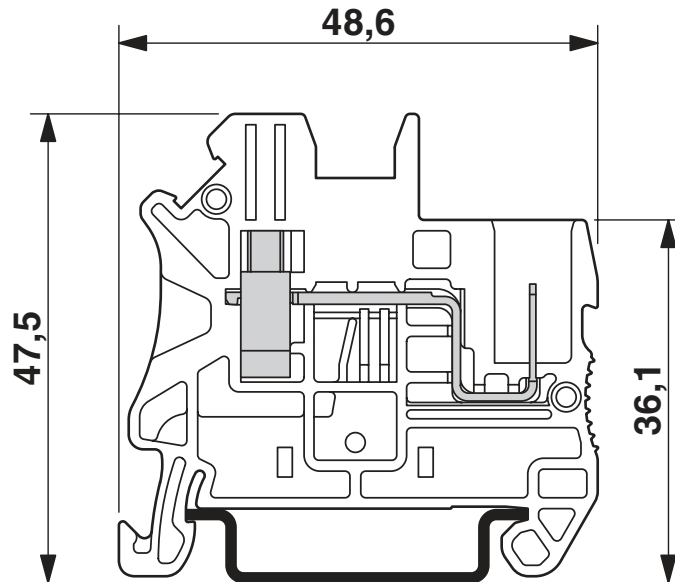

Circuit diagram

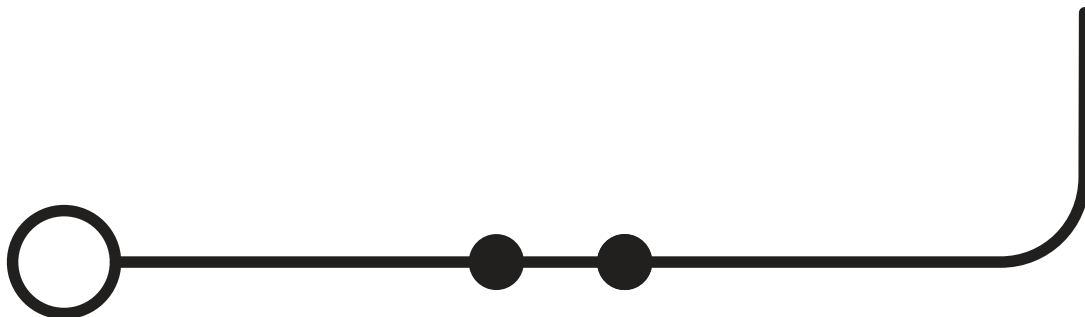

# UT 2,5/1P BU - Feed-through terminal block





3045020

<https://www.phoenixcontact.com/us/products/3045020>

## Approvals

To download certificates, visit the product detail page: <https://www.phoenixcontact.com/us/products/3045020>

 <b>CSA</b> Approval ID: 13631				
	Nominal voltage $U_N$	Nominal current $I_N$	Cross section AWG	Cross section $\text{mm}^2$
Use group B	300 V	20 A	26 - 12	-
Use group C	300 V	20 A	26 - 12	-

 <b>EAC</b> Approval ID: RU C-DE.BL08.B.00534				
---	--	--	--	--

 <b>cULus Recognized</b> Approval ID: E60425				
	Nominal voltage $U_N$	Nominal current $I_N$	Cross section AWG	Cross section $\text{mm}^2$
Use group B	300 V	20 A	26 - 12	-
Multi-conductor connection	300 V	20 A	26 - 16	-
Use group C	300 V	20 A	26 - 12	-
Multi-conductor connection	300 V	20 A	26 - 16	-

# UT 2,5/1P BU - Feed-through terminal block



3045020

<https://www.phoenixcontact.com/us/products/3045020>

## Classifications

### ECLASS

ECLASS-11.0	27141120
ECLASS-13.0	27250117

### ETIM

ETIM 8.0	EC000897
----------	----------

### UNSPSC

UNSPSC 21.0	39121400
-------------	----------



# UT 2,5/1P BU - Feed-through terminal block



3045020

<https://www.phoenixcontact.com/us/products/3045020>

## Environmental product compliance

REACH SVHC	Lead 7439-92-1
China RoHS	Environmentally Friendly Use Period = 50 years
	For information on hazardous substances, refer to the manufacturer's declaration available under "Downloads"

# UT 2,5/1P BU - Feed-through terminal block

3045020

<https://www.phoenixcontact.com/us/products/3045020>

## Accessories

 Note: Applying some accessories below might limit this product.

### FBS 2-5 - Plug-in bridge

3030161

<https://www.phoenixcontact.com/us/products/3030161>



Plug-in bridge, pitch: 5.2 mm, number of positions: 2, length: 23 mm, color: red

 Max. current carrying capacity: 24 A

---

### FBS 3-5 - Plug-in bridge

3030174

<https://www.phoenixcontact.com/us/products/3030174>



Plug-in bridge, pitch: 5.2 mm, number of positions: 3, length: 23 mm, color: red

 Max. current carrying capacity: 24 A

# UT 2,5/1P BU - Feed-through terminal block

3045020

<https://www.phoenixcontact.com/us/products/3045020>



## FBS 4-5 - Plug-in bridge

3030187

<https://www.phoenixcontact.com/us/products/3030187>



Plug-in bridge, pitch: 5.2 mm, number of positions: 4, length: 23 mm, color: red

 Max. current carrying capacity: 24 A

---

## FBS 5-5 - Plug-in bridge

3030190

<https://www.phoenixcontact.com/us/products/3030190>



Plug-in bridge, pitch: 5.2 mm, number of positions: 5, length: 23 mm, color: red

 Max. current carrying capacity: 24 A

# UT 2,5/1P BU - Feed-through terminal block

3045020

<https://www.phoenixcontact.com/us/products/3045020>



## FBS 10-5 - Plug-in bridge

3030213

<https://www.phoenixcontact.com/us/products/3030213>



Plug-in bridge, pitch: 5.2 mm, number of positions: 10, length: 23 mm, color: red

 Max. current carrying capacity: 24 A

---

## FBS 20-5 - Plug-in bridge

3030226

<https://www.phoenixcontact.com/us/products/3030226>



Plug-in bridge, pitch: 5.2 mm, number of positions: 20, color: red

 Max. current carrying capacity: 24 A

# UT 2,5/1P BU - Feed-through terminal block

3045020

<https://www.phoenixcontact.com/us/products/3045020>



## FBS 50-5 - Plug-in bridge

3038930

<https://www.phoenixcontact.com/us/products/3038930>



Plug-in bridge, pitch: 5.2 mm, number of positions: 50, color: red

 Max. current carrying capacity: 24 A

---

## FBSR 2-5 - Plug-in bridge

3033702

<https://www.phoenixcontact.com/us/products/3033702>



Plug-in bridge, pitch: 5.2 mm, number of positions: 2, color: red

 Max. current carrying capacity: 17.5 A

# UT 2,5/1P BU - Feed-through terminal block

3045020

<https://www.phoenixcontact.com/us/products/3045020>



## FBSR 3-5 - Plug-in bridge

3001591

<https://www.phoenixcontact.com/us/products/3001591>



Plug-in bridge, pitch: 5.2 mm, number of positions: 3, color: red

 Max. current carrying capacity: 17.5 A

---

## FBSR 4-5 - Plug-in bridge

3001592

<https://www.phoenixcontact.com/us/products/3001592>



Plug-in bridge, pitch: 5.2 mm, number of positions: 4, color: red

 Max. current carrying capacity: 17.5 A

# UT 2,5/1P BU - Feed-through terminal block

3045020

<https://www.phoenixcontact.com/us/products/3045020>



## FBSR 5-5 - Plug-in bridge

3001593

<https://www.phoenixcontact.com/us/products/3001593>



Plug-in bridge, pitch: 5.2 mm, number of positions: 5, color: red

 Max. current carrying capacity: 17.5 A

---

## FBSR 10-5 - Plug-in bridge

3033710

<https://www.phoenixcontact.com/us/products/3033710>



Plug-in bridge, pitch: 5.2 mm, number of positions: 10, color: red

 Max. current carrying capacity: 17.5 A

# UT 2,5/1P BU - Feed-through terminal block

3045020

<https://www.phoenixcontact.com/us/products/3045020>



## FBS 2-5 BU - Plug-in bridge

3036877

<https://www.phoenixcontact.com/us/products/3036877>



Plug-in bridge, pitch: 5.2 mm, number of positions: 2, color: blue

 Max. current carrying capacity: 24 A

---

## FBS 3-5 BU - Plug-in bridge

3036880

<https://www.phoenixcontact.com/us/products/3036880>



Plug-in bridge, pitch: 5.2 mm, number of positions: 3, color: blue

 Max. current carrying capacity: 24 A



# UT 2,5/1P BU - Feed-through terminal block

3045020

<https://www.phoenixcontact.com/us/products/3045020>



## FBS 4-5 BU - Plug-in bridge

3036893

<https://www.phoenixcontact.com/us/products/3036893>



Plug-in bridge, pitch: 5.2 mm, number of positions: 4, color: blue

 Max. current carrying capacity: 24 A

---

## FBS 5-5 BU - Plug-in bridge

3036903

<https://www.phoenixcontact.com/us/products/3036903>



Plug-in bridge, pitch: 5.2 mm, number of positions: 5, color: blue

 Max. current carrying capacity: 24 A

# UT 2,5/1P BU - Feed-through terminal block

3045020

<https://www.phoenixcontact.com/us/products/3045020>



## FBS 10-5 BU - Plug-in bridge

3036916

<https://www.phoenixcontact.com/us/products/3036916>



Plug-in bridge, pitch: 5.2 mm, number of positions: 10, color: blue

 Max. current carrying capacity: 24 A

---

## FBS 20-5 BU - Plug-in bridge

3036929

<https://www.phoenixcontact.com/us/products/3036929>



Plug-in bridge, pitch: 5.2 mm, number of positions: 20, color: blue

 Max. current carrying capacity: 24 A

# UT 2,5/1P BU - Feed-through terminal block

3045020

<https://www.phoenixcontact.com/us/products/3045020>



## FBS 50-5 BU - Plug-in bridge

3032114

<https://www.phoenixcontact.com/us/products/3032114>



Plug-in bridge, pitch: 5.2 mm, number of positions: 50, color: blue

 Max. current carrying capacity: 24 A

---

## RB ST 10-(2,5/4) - Reducing bridge

3030873

<https://www.phoenixcontact.com/us/products/3030873>



Reducing bridge, pitch: 10 mm, number of positions: 2, length: 36 mm, color: red

 Max. current carrying capacity: 35 A

# UT 2,5/1P BU - Feed-through terminal block



3045020

<https://www.phoenixcontact.com/us/products/3045020>

## RB UT 10-(2,5/4) - Reducing bridge

3047060

<https://www.phoenixcontact.com/us/products/3047060>



Reducing bridge, pitch: 10.2 mm, number of positions: 2, length: 29 mm, color: red

 Max. current carrying capacity: 40 A

---

## RB UT 35-(2,5/4) - Reducing bridge

3047277

<https://www.phoenixcontact.com/us/products/3047277>



Reducing bridge, pitch: 11 mm, number of positions: 2, color: red

 Max. current carrying capacity: 40 A

---

# UT 2,5/1P BU - Feed-through terminal block

3045020

<https://www.phoenixcontact.com/us/products/3045020>

## RB UT 16-(2,5/4) - Reducing bridge

3047073

<https://www.phoenixcontact.com/us/products/3047073>



Reducing bridge, pitch: 11 mm, number of positions: 2, length: 31 mm, color: red

 Max. current carrying capacity: 40 A

---

## RB UT 6-(2,5/4) - Reducing bridge

3047251

<https://www.phoenixcontact.com/us/products/3047251>



Reducing bridge, pitch: 9.5 mm, number of positions: 2, length: 25 mm, color: red

 Max. current carrying capacity: 40 A

# UT 2,5/1P BU - Feed-through terminal block



3045020

<https://www.phoenixcontact.com/us/products/3045020>

## D-UT 2,5/1P - End cover

3047154

<https://www.phoenixcontact.com/us/products/3047154>



End cover, length: 47.6 mm, width: 2.2 mm, height: 47.6 mm, color: gray

---

## ATP-UT - Partition plate

3047167

<https://www.phoenixcontact.com/us/products/3047167>



Partition plate, length: 53.4 mm, width: 2.2 mm, height: 53.4 mm, color: gray

## UT 2,5/1P BU - Feed-through terminal block

3045020

<https://www.phoenixcontact.com/us/products/3045020>



## SZS 0,6X3,5 - Screwdriver

1205053

<https://www.phoenixcontact.com/us/products/1205053>



Actuation tool, for ST terminal blocks, insulated, also suitable for use as a bladed screwdriver, size: 0.6 x 3.5 x 100 mm, 2-component grip, with non-slip grip

---

## X-PEN 0,35 - Marker pen

0811228

<https://www.phoenixcontact.com/us/products/0811228>



Marker pen without ink cartridge, for manual labeling of markers, labeling extremely wipe-proof, line thickness 0.35 mm

# UT 2,5/1P BU - Feed-through terminal block

3045020

<https://www.phoenixcontact.com/us/products/3045020>



## UT 2,5/1P-F - Screw flange

3060445

<https://www.phoenixcontact.com/us/products/3060445>



Screw flange, for screwing COMBI plugs, with the same structure and pitch as the relevant COMBI terminal blocks

---

## P-CO 2-5 R47K - Component connector

3032447

<https://www.phoenixcontact.com/us/products/3032447>



Component connector, with 47 kOhm resistance for wire-break monitoring, pitch: 5.2 mm, length: 8.9 mm, width: 4.1 mm, height: 8.9 mm, number of positions: 2, color: black



# UT 2,5/1P BU - Feed-through terminal block

3045020

<https://www.phoenixcontact.com/us/products/3045020>

## PC - Coding star

3040588

<https://www.phoenixcontact.com/us/products/3040588>



Coding star, 4-section, length: 3 mm, width: 3 mm, height: 3 mm, color: red

---

## SF-SL 0,6X3,5-100 S-VDE - Screwdriver

1212587

<https://www.phoenixcontact.com/us/products/1212587>



Actuation tool, for ST terminal blocks, VDE insulated, with slimmer insulation integrated in the blade, also suitable for use as a bladed screwdriver, size: 0.6 x 3.5 x 100 mm, 2-component grip, with non-slip grip

# UT 2,5/1P BU - Feed-through terminal block

3045020

<https://www.phoenixcontact.com/us/products/3045020>



## NS 35/ 7,5 PERF 2000MM - DIN rail perforated

0801733

<https://www.phoenixcontact.com/us/products/0801733>



DIN rail perforated, acc. to EN 60715, material: Steel, galvanized, passivated with a thick layer, Standard profile, color: silver, Pack of 25 (50 m)

---

## NS 35/ 7,5 UNPERF 2000MM - DIN rail, unperforated

0801681

<https://www.phoenixcontact.com/us/products/0801681>



DIN rail, unperforated, acc. to EN 60715, material: Steel, galvanized, passivated with a thick layer, Standard profile, color: silver, Pack of 25 (50 m)

# UT 2,5/1P BU - Feed-through terminal block

3045020

<https://www.phoenixcontact.com/us/products/3045020>



## NS 35/ 7,5 WH PERF 2000MM - DIN rail perforated

1204119

<https://www.phoenixcontact.com/us/products/1204119>



DIN rail perforated, acc. to EN 60715, material: Steel, Galvanized, white passivated, Standard profile, color: silver, Pack of 25 (50 m)

---

## NS 35/ 7,5 WH UNPERF 2000MM-VPE 10 - DIN rail, unperforated

1204122

<https://www.phoenixcontact.com/us/products/1204122>



DIN rail, unperforated, acc. to EN 60715, material: Steel, Galvanized, white passivated, Standard profile, color: silver, Pack of 10 (20 m)

# UT 2,5/1P BU - Feed-through terminal block

3045020

<https://www.phoenixcontact.com/us/products/3045020>



## NS 35/ 7,5 AL UNPERF 2000MM - DIN rail, unperforated

0801704

<https://www.phoenixcontact.com/us/products/0801704>



DIN rail, unperforated, acc. to EN 60715, material: Aluminum, uncoated, Standard profile, color: silver, Pack of 25 (50 m)

---

## NS 35/ 7,5 ZN PERF 2000MM - DIN rail perforated

1206421

<https://www.phoenixcontact.com/us/products/1206421>



DIN rail perforated, acc. to EN 60715, material: Steel, galvanized, Standard profile, color: silver, Pack of 25 (50 m)

# UT 2,5/1P BU - Feed-through terminal block

3045020

<https://www.phoenixcontact.com/us/products/3045020>



## NS 35/ 7,5 ZN UNPERF 2000MM - DIN rail, unperforated

1206434

<https://www.phoenixcontact.com/us/products/1206434>



DIN rail, unperforated, acc. to EN 60715, material: Steel, galvanized, Standard profile, color: silver, Pack of 25 (50 m)

---

## NS 35/ 7,5 CU UNPERF 2000MM-VPE 10 - DIN rail, unperforated

0801762

<https://www.phoenixcontact.com/us/products/0801762>



DIN rail, unperforated, acc. to EN 60715, material: Copper, uncoated, Standard profile, color: copper-colored, Pack of 10 (20 m)

# UT 2,5/1P BU - Feed-through terminal block

3045020

<https://www.phoenixcontact.com/us/products/3045020>



## NS 35/ 7,5 CAP - End cap

1206560

<https://www.phoenixcontact.com/us/products/1206560>

DIN rail end piece, for DIN rail NS 35/7.5



---

## NS 35/15 PERF 2000MM - DIN rail perforated

1201730

<https://www.phoenixcontact.com/us/products/1201730>



DIN rail perforated, similar to EN 60715, material: Steel, galvanized, passivated with a thick layer, Standard profile, color: silver, Pack of 25 (50 m)

# UT 2,5/1P BU - Feed-through terminal block

3045020

<https://www.phoenixcontact.com/us/products/3045020>



## NS 35/15 UNPERF 2000MM - DIN rail, unperforated

1201714

<https://www.phoenixcontact.com/us/products/1201714>



DIN rail, unperforated, similar to EN 60715, material: Steel, galvanized, passivated with a thick layer, Standard profile, color: silver, Pack of 25 (50 m)

---

## NS 35/15 WH PERF 2000MM - DIN rail perforated

0806602

<https://www.phoenixcontact.com/us/products/0806602>



DIN rail perforated, similar to EN 60715, material: Steel, Galvanized, white passivated, Standard profile, color: white, Pack of 25 (50 m)

# UT 2,5/1P BU - Feed-through terminal block

3045020

<https://www.phoenixcontact.com/us/products/3045020>



## NS 35/15 WH UNPERF 2000MM-VPE 10 - DIN rail, unperforated

1204135

<https://www.phoenixcontact.com/us/products/1204135>



DIN rail, unperforated, similar to EN 60715, material: Steel, Galvanized, white passivated, Standard profile, color: silver, Pack of 10 (20 m)

---

## NS 35/15 AL UNPERF 2000MM - DIN rail, unperforated

1201756

<https://www.phoenixcontact.com/us/products/1201756>



DIN rail, unperforated, similar to EN 60715, material: Aluminum, uncoated, Standard profile, color: silver



# UT 2,5/1P BU - Feed-through terminal block

3045020

<https://www.phoenixcontact.com/us/products/3045020>



## NS 35/15 ZN PERF 2000MM - DIN rail perforated

1206599

<https://www.phoenixcontact.com/us/products/1206599>



DIN rail perforated, similar to EN 60715, material: Steel, galvanized, Standard profile, color: silver, Pack of 25 (50 m)

---

## NS 35/15 ZN UNPERF 2000MM - DIN rail, unperforated

1206586

<https://www.phoenixcontact.com/us/products/1206586>



DIN rail, unperforated, similar to EN 60715, material: Steel, galvanized, Standard profile, color: silver, Pack of 25 (50 m)

# UT 2,5/1P BU - Feed-through terminal block

3045020

<https://www.phoenixcontact.com/us/products/3045020>



## NS 35/15 CU UNPERF 2000MM-VPE 10 - DIN rail, unperforated

1201895

<https://www.phoenixcontact.com/us/products/1201895>



DIN rail, unperforated, similar to EN 60715, material: Copper, uncoated, Standard profile, color: copper-colored, Pack of 10 (20 m)

---

## NS 35/15 CAP - End cap

1206573

<https://www.phoenixcontact.com/us/products/1206573>

DIN rail end piece, for DIN rail NS 35/15



# UT 2,5/1P BU - Feed-through terminal block

3045020

<https://www.phoenixcontact.com/us/products/3045020>



## NS 35/15-2,3 UNPERF 2000MM-VPE 10 - DIN rail, unperforated

1201798

<https://www.phoenixcontact.com/us/products/1201798>



DIN rail, unperforated, acc. to EN 60715, material: Steel, galvanized, passivated with a thick layer, Standard profile 2.3 mm, color: silver, Pack of 10 (20 m)

---

## ZB 5 :UNBEDRUCKT - Zack marker strip

1050004

<https://www.phoenixcontact.com/us/products/1050004>



Zack marker strip, Strip, white, unlabeled, can be labeled with: PLOTMARK, CMS-P1-PLOTTER, mounting type: snapped, for terminal block width: 5.2 mm, lettering field size: 5.1 x 10.5 mm, Number of individual labels: 10

# UT 2,5/1P BU - Feed-through terminal block

3045020

<https://www.phoenixcontact.com/us/products/3045020>

## ZB 5 CUS - Zack marker strip

0824962

<https://www.phoenixcontact.com/us/products/0824962>



Zack marker strip, can be ordered: Strip, white, labeled according to customer specifications, mounting type: snap into tall marker groove, for terminal block width: 5.2 mm, lettering field size: 5.15 x 10.5 mm, Number of individual labels: 10

---

## ZB 5,LGS:FORTL.ZAHLEN - Zack marker strip

1050017

<https://www.phoenixcontact.com/us/products/1050017>



Zack marker strip, Strip, white, labeled, printed horizontally: consecutive numbers 1 ... 10, 11 ... 20, etc. up to 491 ... 500, mounting type: snapped, for terminal block width: 5.2 mm, lettering field size: 5.15 x 10.5 mm, Number of individual labels: 10

# UT 2,5/1P BU - Feed-through terminal block



3045020

<https://www.phoenixcontact.com/us/products/3045020>

## ZB 5,QR:FORTL.ZAHLEN - Zack marker strip

1050020

<https://www.phoenixcontact.com/us/products/1050020>



Zack marker strip, white, Printed vertically: consecutive numbers 1 ... 10, 11 ... 20, etc. up to 491 ... 500, mounting type: snapped, for terminal block width: 5.2 mm, lettering field size: 5.15 x 10.5 mm

---

## ZB 5,LGS:GLEICHE ZAHLEN - Zack marker strip

1050033

<https://www.phoenixcontact.com/us/products/1050033>



Zack marker strip, Strip, white, labeled, can be labeled with: CMS-P1-PLOTTER, printed horizontally: Identical numbers 1 or 2, etc. up to 100, mounting type: snapped, for terminal block width: 5.2 mm, lettering field size: 5.15 x 10.5 mm, Number of individual labels: 10

# UT 2,5/1P BU - Feed-through terminal block



3045020

<https://www.phoenixcontact.com/us/products/3045020>

## ZB 5,LGS:L1-N,PE - Zack marker strip

1050415

<https://www.phoenixcontact.com/us/products/1050415>



Zack marker strip, Strip, white, labeled, horizontal: L1, L2, L3, N, PE, L1, L2, L3, N, PE, mounting type: snapped, for terminal block width: 5.2 mm, lettering field size: 5.15 x 10.5 mm, Number of individual labels: 10

---

## UC-TM 5 - Marker for terminal blocks

0818108

<https://www.phoenixcontact.com/us/products/0818108>



Marker for terminal blocks, Sheet, white, unlabeled, can be labeled with: BLUEMARK ID COLOR, BLUEMARK ID, BLUEMARK CLED, PLOTMARK, CMS-P1-PLOTTER, mounting type: snapped, for terminal block width: 5.2 mm, lettering field size: 4.6 x 10.5 mm, Number of individual labels: 96

# UT 2,5/1P BU - Feed-through terminal block



3045020

<https://www.phoenixcontact.com/us/products/3045020>

## UC-TM 5 CUS - Marker for terminal blocks

0824581

<https://www.phoenixcontact.com/us/products/0824581>



Marker for terminal blocks, can be ordered: by sheet, white, labeled according to customer specifications, mounting type: snap into tall marker groove, for terminal block width: 5.2 mm, lettering field size: 10.5 x 4.6 mm, Number of individual labels: 96

---

## UCT-TM 5 - Marker for terminal blocks

0828734

<https://www.phoenixcontact.com/us/products/0828734>



Marker for terminal blocks, Sheet, white, unlabeled, can be labeled with: TOPMARK NEO, TOPMARK LASER, BLUEMARK ID COLOR, BLUEMARK ID, BLUEMARK CLED, THERMOMARK PRIME, THERMOMARK CARD 2.0, THERMOMARK CARD, mounting type: snapped, for terminal block width: 5.2 mm, lettering field size: 4.6 x 10.5 mm, Number of individual labels: 72

# UT 2,5/1P BU - Feed-through terminal block

3045020

<https://www.phoenixcontact.com/us/products/3045020>



## UCT-TM 5 CUS - Marker for terminal blocks

0829595

<https://www.phoenixcontact.com/us/products/0829595>



Marker for terminal blocks, can be ordered: by sheet, white, labeled according to customer specifications, mounting type: snap into tall marker groove, for terminal block width: 5.2 mm, lettering field size: 4.6 x 10.5 mm, Number of individual labels: 72

---

## GBS 5-25X12 - Group marker label for terminal marking

0810588

<https://www.phoenixcontact.com/us/products/0810588>



Group marker label, snaps onto terminal center for screw, spring-cage and quick connection terminal blocks, labeled with a 25 x 12 mm label or manually with the B-STIFT, in the foot part with ZB 5



# UT 2,5/1P BU - Feed-through terminal block



3045020

<https://www.phoenixcontact.com/us/products/3045020>

## GBS 5-25X5 - Group marker label for terminal marking

0829126

<https://www.phoenixcontact.com/us/products/0829126>



Group marking label, can be snapped into terminal center for screw, spring-cage, push-in, and fast connection terminal blocks, can be labeled with a 24 x 4 mm label or manually using B-STIFT, in the foot part with ZB 5

---

## STP 5-2-ZB - Marker carriers

3037643

<https://www.phoenixcontact.com/us/products/3037643>



Marker carriers, snaps into ST 2,5 spring-cage terminal blocks, can be marked with UC-TM 5, UC-TMF 5, UCT-TM 5, UCT-TMF 5, ZB 5, or ZBF 5, gray, unlabeled, mounting type: snapped

# UT 2,5/1P BU - Feed-through terminal block

3045020

<https://www.phoenixcontact.com/us/products/3045020>



## MPS-MT - Test plugs

0201744

<https://www.phoenixcontact.com/us/products/0201744>



Test plugs, with solder connection up to 1 mm<sup>2</sup> conductor cross section, number of positions: 1, color: gray

---

## MPS-IH WH - Insulating sleeve

0201663

<https://www.phoenixcontact.com/us/products/0201663>

Insulating sleeve, color: white



# UT 2,5/1P BU - Feed-through terminal block

3045020

<https://www.phoenixcontact.com/us/products/3045020>



## MPS-IH RD - Insulating sleeve

0201676

<https://www.phoenixcontact.com/us/products/0201676>

Insulating sleeve, color: red



---

## MPS-IH BU - Insulating sleeve

0201689

<https://www.phoenixcontact.com/us/products/0201689>

Insulating sleeve, color: blue



# UT 2,5/1P BU - Feed-through terminal block

3045020

<https://www.phoenixcontact.com/us/products/3045020>



## MPS-IH YE - Insulating sleeve

0201692

<https://www.phoenixcontact.com/us/products/0201692>

Insulating sleeve, color: yellow



---

## MPS-IH GN - Insulating sleeve

0201702

<https://www.phoenixcontact.com/us/products/0201702>

Insulating sleeve, color: green



# UT 2,5/1P BU - Feed-through terminal block

3045020

<https://www.phoenixcontact.com/us/products/3045020>



## MPS-IH GY - Insulating sleeve

0201728

<https://www.phoenixcontact.com/us/products/0201728>

Insulating sleeve, color: gray



---

## MPS-IH BK - Insulating sleeve

0201731

<https://www.phoenixcontact.com/us/products/0201731>

Insulating sleeve, color: black



# UT 2,5/1P BU - Feed-through terminal block



3045020

<https://www.phoenixcontact.com/us/products/3045020>

## PAI-4-FIX-5/6 BU - Test adapter

3035975

<https://www.phoenixcontact.com/us/products/3035975>



4 mm test adapter, for terminal blocks with 5.2 mm and 6.2 mm pitch

---

## PAI-4-FIX-5/6 OG - Test adapter

3035974

<https://www.phoenixcontact.com/us/products/3035974>



4 mm test adapter, for terminal blocks with 5.2 mm and 6.2 mm pitch

# UT 2,5/1P BU - Feed-through terminal block



3045020

<https://www.phoenixcontact.com/us/products/3045020>

## PAI-4-FIX-5/6 YE - Test adapter

3035977

<https://www.phoenixcontact.com/us/products/3035977>



4 mm test adapter, for terminal blocks with 5.2 mm and 6.2 mm pitch

---

## PAI-4-FIX-5/6 RD - Test adapter

3035976

<https://www.phoenixcontact.com/us/products/3035976>



4 mm test adapter, for terminal blocks with 5.2 mm and 6.2 mm pitch

# UT 2,5/1P BU - Feed-through terminal block



3045020

<https://www.phoenixcontact.com/us/products/3045020>

## PAI-4-FIX-5/6 GN - Test adapter

3035978

<https://www.phoenixcontact.com/us/products/3035978>



4 mm test adapter, for terminal blocks with 5.2 mm and 6.2 mm pitch

---

## PAI-4-FIX-5/6 BK - Test adapter

3035980

<https://www.phoenixcontact.com/us/products/3035980>



4 mm test adapter, for terminal blocks with 5.2 mm and 6.2 mm pitch



# UT 2,5/1P BU - Feed-through terminal block



3045020

<https://www.phoenixcontact.com/us/products/3045020>

## PAI-4-FIX-5/6 GY - Test adapter

3035982

<https://www.phoenixcontact.com/us/products/3035982>



4 mm test adapter, for terminal blocks with 5.2 mm and 6.2 mm pitch

---

## PAI-4-FIX-5/6 VT - Test adapter

3035979

<https://www.phoenixcontact.com/us/products/3035979>



4 mm test adapter, for terminal blocks with 5.2 mm and 6.2 mm pitch

# UT 2,5/1P BU - Feed-through terminal block



3045020

<https://www.phoenixcontact.com/us/products/3045020>

## PAI-4-FIX-5/6 BN - Test adapter

3035981

<https://www.phoenixcontact.com/us/products/3035981>



4 mm test adapter, for terminal blocks with 5.2 mm and 6.2 mm pitch

---

## PAI-4-FIX-5/6 WH - Test adapter

3035983

<https://www.phoenixcontact.com/us/products/3035983>



4 mm test adapter, for terminal blocks with 5.2 mm and 6.2 mm pitch

# UT 2,5/1P BU - Feed-through terminal block

3045020

<https://www.phoenixcontact.com/us/products/3045020>



## PS-5 - Test plugs

3030983

<https://www.phoenixcontact.com/us/products/3030983>



Test plugs, Modular test plug, number of positions: 1, color: red

---

## DP PS-5 - Spacer plate

3036725

<https://www.phoenixcontact.com/us/products/3036725>



Spacer plate, length: 22.4 mm, width: 5.2 mm, height: 22.4 mm, number of positions: 1, color: red

# UT 2,5/1P BU - Feed-through terminal block

3045020

<https://www.phoenixcontact.com/us/products/3045020>



## PS-5/2,3MM RD - Test plugs

3038723

<https://www.phoenixcontact.com/us/products/3038723>



Test plugs, number of positions: 1, color: red

---

## CLIPFIX 35 - End clamp

3022218

<https://www.phoenixcontact.com/us/products/3022218>



Quick mounting end clamp for NS 35/7,5 DIN rail or NS 35/15 DIN rail, with marking option, width: 9.5 mm, color: gray

# UT 2,5/1P BU - Feed-through terminal block

3045020

<https://www.phoenixcontact.com/us/products/3045020>

## CLIPFIX 35-5 - End clamp

3022276

<https://www.phoenixcontact.com/us/products/3022276>



Quick mounting end clamp for NS 35/7,5 DIN rail or NS 35/15 DIN rail, with marking option, with parking option for FBS...5, FBS...6, KSS 5, KSS 6, width: 5.15 mm, color: gray

---

## E/NS 35 N - End clamp

0800886

<https://www.phoenixcontact.com/us/products/0800886>



End clamp, width: 9.5 mm, color: gray

# UT 2,5/1P BU - Feed-through terminal block



3045020

<https://www.phoenixcontact.com/us/products/3045020>

## PAI-4-N GY - Test adapter

3032871

<https://www.phoenixcontact.com/us/products/3032871>



4 mm test adapter, for terminal blocks with 5.2 mm, 6.2 mm and 8.2 mm pitch

---

## SP 2,5/ 1 - Plug

3040258

<https://www.phoenixcontact.com/us/products/3040258>



Plug, nom. voltage: 500 V, nominal current: 24 A, number of positions: 1, connection method: Spring-cage connection, Rated cross section: 2.5 mm<sup>2</sup>, cross section: 0.08 mm<sup>2</sup>- 4 mm<sup>2</sup>, color: gray

# UT 2,5/1P BU - Feed-through terminal block

3045020

<https://www.phoenixcontact.com/us/products/3045020>

## SP 2,5/ 2 - Plug

3040261

<https://www.phoenixcontact.com/us/products/3040261>



Plug, nom. voltage: 500 V, nominal current: 24 A, number of positions: 2, connection method: Spring-cage connection, Rated cross section: 2.5 mm<sup>2</sup>, cross section: 0.08 mm<sup>2</sup>- 4 mm<sup>2</sup>, color: gray

---

## SP 2,5/ 3 - Plug

3040274

<https://www.phoenixcontact.com/us/products/3040274>



Plug, nom. voltage: 500 V, nominal current: 24 A, number of positions: 3, connection method: Spring-cage connection, Rated cross section: 2.5 mm<sup>2</sup>, cross section: 0.08 mm<sup>2</sup>- 4 mm<sup>2</sup>, color: gray

# UT 2,5/1P BU - Feed-through terminal block

3045020

<https://www.phoenixcontact.com/us/products/3045020>

## SP 2,5/ 4 - Plug

3040287

<https://www.phoenixcontact.com/us/products/3040287>



Plug, nom. voltage: 500 V, nominal current: 24 A, number of positions: 4, connection method: Spring-cage connection, Rated cross section: 2.5 mm<sup>2</sup>, cross section: 0.08 mm<sup>2</sup>- 4 mm<sup>2</sup>, color: gray

---

## SP 2,5/ 5 - Plug

3040290

<https://www.phoenixcontact.com/us/products/3040290>



Plug, nom. voltage: 500 V, nominal current: 24 A, number of positions: 5, connection method: Spring-cage connection, Rated cross section: 2.5 mm<sup>2</sup>, cross section: 0.08 mm<sup>2</sup>- 4 mm<sup>2</sup>, color: gray



# UT 2,5/1P BU - Feed-through terminal block

3045020

<https://www.phoenixcontact.com/us/products/3045020>

## SP 2,5/ 6 - Plug

3040300

<https://www.phoenixcontact.com/us/products/3040300>



Plug, nom. voltage: 500 V, nominal current: 24 A, number of positions: 6, connection method: Spring-cage connection, Rated cross section: 2.5 mm<sup>2</sup>, cross section: 0.08 mm<sup>2</sup>- 4 mm<sup>2</sup>, color: gray

---

## SP 2,5/ 7 - Plug

3040313

<https://www.phoenixcontact.com/us/products/3040313>



Plug, nom. voltage: 500 V, nominal current: 24 A, number of positions: 7, connection method: Spring-cage connection, Rated cross section: 2.5 mm<sup>2</sup>, cross section: 0.08 mm<sup>2</sup>- 4 mm<sup>2</sup>, color: gray

# UT 2,5/1P BU - Feed-through terminal block

3045020

<https://www.phoenixcontact.com/us/products/3045020>

## SP 2,5/ 8 - Plug

3040326

<https://www.phoenixcontact.com/us/products/3040326>



Plug, nom. voltage: 500 V, nominal current: 24 A, number of positions: 8, connection method: Spring-cage connection, Rated cross section: 2.5 mm<sup>2</sup>, cross section: 0.08 mm<sup>2</sup>- 4 mm<sup>2</sup>, color: gray

---

## SP 2,5/ 9 - Plug

3040339

<https://www.phoenixcontact.com/us/products/3040339>



Plug, nom. voltage: 500 V, nominal current: 24 A, number of positions: 9, connection method: Spring-cage connection, Rated cross section: 2.5 mm<sup>2</sup>, cross section: 0.08 mm<sup>2</sup>- 4 mm<sup>2</sup>, color: gray

# UT 2,5/1P BU - Feed-through terminal block

3045020

<https://www.phoenixcontact.com/us/products/3045020>

## SP 2,5/10 - Plug

3040342

<https://www.phoenixcontact.com/us/products/3040342>



Plug, nom. voltage: 500 V, nominal current: 24 A, number of positions: 10, connection method: Spring-cage connection, Rated cross section: 2.5 mm<sup>2</sup>, cross section: 0.08 mm<sup>2</sup>- 4 mm<sup>2</sup>, color: gray

---

## SP 2,5/11 - Plug

3040355

<https://www.phoenixcontact.com/us/products/3040355>



Plug, nom. voltage: 500 V, nominal current: 24 A, number of positions: 11, connection method: Spring-cage connection, Rated cross section: 2.5 mm<sup>2</sup>, cross section: 0.08 mm<sup>2</sup>- 4 mm<sup>2</sup>, color: gray

# UT 2,5/1P BU - Feed-through terminal block

3045020

<https://www.phoenixcontact.com/us/products/3045020>

## SP 2,5/12 - Plug

3040368

<https://www.phoenixcontact.com/us/products/3040368>



Plug, nom. voltage: 500 V, nominal current: 24 A, number of positions: 12, connection method: Spring-cage connection, Rated cross section: 2.5 mm<sup>2</sup>, cross section: 0.08 mm<sup>2</sup>- 4 mm<sup>2</sup>, color: gray

---

## SP 2,5/13 - Plug

3040371

<https://www.phoenixcontact.com/us/products/3040371>



Plug, nom. voltage: 500 V, nominal current: 24 A, number of positions: 13, connection method: Spring-cage connection, Rated cross section: 2.5 mm<sup>2</sup>, cross section: 0.08 mm<sup>2</sup>- 4 mm<sup>2</sup>, color: gray

# UT 2,5/1P BU - Feed-through terminal block

3045020

<https://www.phoenixcontact.com/us/products/3045020>

## SP 2,5/14 - Plug

3040384

<https://www.phoenixcontact.com/us/products/3040384>



Plug, nom. voltage: 500 V, nominal current: 24 A, number of positions: 14, connection method: Spring-cage connection, Rated cross section: 2.5 mm<sup>2</sup>, cross section: 0.08 mm<sup>2</sup>- 4 mm<sup>2</sup>, color: gray

---

## SP 2,5/15 - Plug

3040397

<https://www.phoenixcontact.com/us/products/3040397>



Plug, nom. voltage: 500 V, nominal current: 24 A, number of positions: 15, connection method: Spring-cage connection, Rated cross section: 2.5 mm<sup>2</sup>, cross section: 0.08 mm<sup>2</sup>- 4 mm<sup>2</sup>, color: gray

# UT 2,5/1P BU - Feed-through terminal block

3045020

<https://www.phoenixcontact.com/us/products/3045020>

## SP 2,5/ 1 BU - Plug

3040698

<https://www.phoenixcontact.com/us/products/3040698>



Plug, nom. voltage: 500 V, nominal current: 24 A, number of positions: 1, connection method: Spring-cage connection, Rated cross section: 2.5 mm<sup>2</sup>, cross section: 0.08 mm<sup>2</sup>- 4 mm<sup>2</sup>, color: blue

---

## SP 2,5/ 1 GNYE - Plug

3040708

<https://www.phoenixcontact.com/us/products/3040708>



Plug, nom. voltage: 500 V, nominal current: 24 A, number of positions: 1, connection method: Spring-cage connection, Rated cross section: 2.5 mm<sup>2</sup>, cross section: 0.08 mm<sup>2</sup>- 4 mm<sup>2</sup>, color: green-yellow

# UT 2,5/1P BU - Feed-through terminal block

3045020

<https://www.phoenixcontact.com/us/products/3045020>

## SPB 2,5/ 1 - Plug

3040106

<https://www.phoenixcontact.com/us/products/3040106>



Plug, nom. voltage: 500 V, nominal current: 24 A, number of positions: 1, connection method: Spring-cage connection, Rated cross section: 2.5 mm<sup>2</sup>, cross section: 0.08 mm<sup>2</sup>- 4 mm<sup>2</sup>, color: gray

---

## SPB 2,5/ 2 - Plug

3040119

<https://www.phoenixcontact.com/us/products/3040119>



Plug, nom. voltage: 500 V, nominal current: 24 A, number of positions: 2, connection method: Spring-cage connection, Rated cross section: 2.5 mm<sup>2</sup>, cross section: 0.08 mm<sup>2</sup>- 4 mm<sup>2</sup>, color: gray

# UT 2,5/1P BU - Feed-through terminal block

3045020

<https://www.phoenixcontact.com/us/products/3045020>

## SPB 2,5/ 3 - Plug

3040122

<https://www.phoenixcontact.com/us/products/3040122>



Plug, nom. voltage: 500 V, nominal current: 24 A, number of positions: 3, connection method: Spring-cage connection, Rated cross section: 2.5 mm<sup>2</sup>, cross section: 0.08 mm<sup>2</sup>- 4 mm<sup>2</sup>, color: gray

---

## SPB 2,5/ 4 - Plug

3040135

<https://www.phoenixcontact.com/us/products/3040135>



Plug, nom. voltage: 500 V, nominal current: 24 A, number of positions: 4, connection method: Spring-cage connection, Rated cross section: 2.5 mm<sup>2</sup>, cross section: 0.08 mm<sup>2</sup>- 4 mm<sup>2</sup>, color: gray



# UT 2,5/1P BU - Feed-through terminal block

3045020

<https://www.phoenixcontact.com/us/products/3045020>

## SPB 2,5/ 5 - Plug

3040143

<https://www.phoenixcontact.com/us/products/3040143>



Plug, nom. voltage: 500 V, nominal current: 24 A, number of positions: 5, connection method: Spring-cage connection, Rated cross section: 2.5 mm<sup>2</sup>, cross section: 0.08 mm<sup>2</sup>- 4 mm<sup>2</sup>, color: gray

---

## SPB 2,5/ 6 - Plug

3040151

<https://www.phoenixcontact.com/us/products/3040151>



Plug, nom. voltage: 500 V, nominal current: 24 A, number of positions: 6, connection method: Spring-cage connection, Rated cross section: 2.5 mm<sup>2</sup>, cross section: 0.08 mm<sup>2</sup>- 4 mm<sup>2</sup>, color: gray

# UT 2,5/1P BU - Feed-through terminal block

3045020

<https://www.phoenixcontact.com/us/products/3045020>

## SPB 2,5/ 7 - Plug

3040164

<https://www.phoenixcontact.com/us/products/3040164>



Plug, nom. voltage: 500 V, nominal current: 24 A, number of positions: 7, connection method: Spring-cage connection, Rated cross section: 2.5 mm<sup>2</sup>, cross section: 0.08 mm<sup>2</sup>- 4 mm<sup>2</sup>, color: gray

---

## SPB 2,5/ 8 - Plug

3040177

<https://www.phoenixcontact.com/us/products/3040177>



Plug, nom. voltage: 500 V, nominal current: 24 A, number of positions: 8, connection method: Spring-cage connection, Rated cross section: 2.5 mm<sup>2</sup>, cross section: 0.08 mm<sup>2</sup>- 4 mm<sup>2</sup>, color: gray

# UT 2,5/1P BU - Feed-through terminal block

3045020

<https://www.phoenixcontact.com/us/products/3045020>

## SPB 2,5/ 9 - Plug

3040180

<https://www.phoenixcontact.com/us/products/3040180>



Plug, nom. voltage: 500 V, nominal current: 24 A, number of positions: 9, connection method: Spring-cage connection, Rated cross section: 2.5 mm<sup>2</sup>, cross section: 0.08 mm<sup>2</sup>- 4 mm<sup>2</sup>, color: gray

---

## SPB 2,5/10 - Plug

3040193

<https://www.phoenixcontact.com/us/products/3040193>



Plug, nom. voltage: 500 V, nominal current: 24 A, number of positions: 10, connection method: Spring-cage connection, Rated cross section: 2.5 mm<sup>2</sup>, cross section: 0.08 mm<sup>2</sup>- 4 mm<sup>2</sup>, color: gray

# UT 2,5/1P BU - Feed-through terminal block

3045020

<https://www.phoenixcontact.com/us/products/3045020>

## SPB 2,5/11 - Plug

3040203

<https://www.phoenixcontact.com/us/products/3040203>



Plug, nom. voltage: 500 V, nominal current: 24 A, number of positions: 11, connection method: Spring-cage connection, Rated cross section: 2.5 mm<sup>2</sup>, cross section: 0.08 mm<sup>2</sup>- 4 mm<sup>2</sup>, color: gray

---

## SPB 2,5/12 - Plug

3040216

<https://www.phoenixcontact.com/us/products/3040216>



Plug, nom. voltage: 500 V, nominal current: 24 A, number of positions: 12, connection method: Spring-cage connection, Rated cross section: 2.5 mm<sup>2</sup>, cross section: 0.08 mm<sup>2</sup>- 4 mm<sup>2</sup>, color: gray

# UT 2,5/1P BU - Feed-through terminal block

3045020

<https://www.phoenixcontact.com/us/products/3045020>

## SPB 2,5/13 - Plug

3040229

<https://www.phoenixcontact.com/us/products/3040229>



Plug, nom. voltage: 500 V, nominal current: 24 A, number of positions: 13, connection method: Spring-cage connection, Rated cross section: 2.5 mm<sup>2</sup>, cross section: 0.08 mm<sup>2</sup>- 4 mm<sup>2</sup>, color: gray

---

## SPB 2,5/14 - Plug

3040232

<https://www.phoenixcontact.com/us/products/3040232>



Plug, nom. voltage: 500 V, nominal current: 24 A, number of positions: 14, connection method: Spring-cage connection, Rated cross section: 2.5 mm<sup>2</sup>, cross section: 0.08 mm<sup>2</sup>- 4 mm<sup>2</sup>, color: gray

# UT 2,5/1P BU - Feed-through terminal block

3045020

<https://www.phoenixcontact.com/us/products/3045020>

## SPB 2,5/15 - Plug

3040245

<https://www.phoenixcontact.com/us/products/3040245>



Plug, nom. voltage: 500 V, nominal current: 24 A, number of positions: 15, connection method: Spring-cage connection, Rated cross section: 2.5 mm<sup>2</sup>, cross section: 0.08 mm<sup>2</sup>- 4 mm<sup>2</sup>, color: gray

---

## SPB 2,5/ 1 BU - Plug

3040724

<https://www.phoenixcontact.com/us/products/3040724>



Plug, nom. voltage: 500 V, nominal current: 24 A, number of positions: 1, connection method: Spring-cage connection, Rated cross section: 2.5 mm<sup>2</sup>, cross section: 0.08 mm<sup>2</sup>- 4 mm<sup>2</sup>, color: blue

# UT 2,5/1P BU - Feed-through terminal block

3045020

<https://www.phoenixcontact.com/us/products/3045020>

## SPB 2,5/ 1 GNYE - Plug

3040711

<https://www.phoenixcontact.com/us/products/3040711>



Plug, nom. voltage: 500 V, nominal current: 24 A, number of positions: 1, connection method: Spring-cage connection, Rated cross section: 2.5 mm<sup>2</sup>, cross section: 0.08 mm<sup>2</sup>- 4 mm<sup>2</sup>, color: green-yellow

---

## UPBV 2,5/ 1 - Plug

3045145

<https://www.phoenixcontact.com/us/products/3045145>



Plug, nom. voltage: 500 V, nominal current: 24 A, number of positions: 1, connection method: Screw connection, Rated cross section: 2.5 mm<sup>2</sup>, cross section: 0.14 mm<sup>2</sup>- 4 mm<sup>2</sup>, color: gray

# UT 2,5/1P BU - Feed-through terminal block

3045020

<https://www.phoenixcontact.com/us/products/3045020>

## UPBV 2,5/ 2 - Plug

3045402

<https://www.phoenixcontact.com/us/products/3045402>



Plug, nom. voltage: 500 V, nominal current: 24 A, number of positions: 2, connection method: Screw connection, Rated cross section: 2.5 mm<sup>2</sup>, cross section: 0.14 mm<sup>2</sup>- 4 mm<sup>2</sup>, color: gray

---

## UPBV 2,5/ 3 - Plug

3045415

<https://www.phoenixcontact.com/us/products/3045415>



Plug, nom. voltage: 500 V, nominal current: 24 A, number of positions: 3, connection method: Screw connection, Rated cross section: 2.5 mm<sup>2</sup>, cross section: 0.14 mm<sup>2</sup>- 4 mm<sup>2</sup>, color: gray



# UT 2,5/1P BU - Feed-through terminal block

3045020

<https://www.phoenixcontact.com/us/products/3045020>

## UPBV 2,5/ 4 - Plug

3045428

<https://www.phoenixcontact.com/us/products/3045428>



Plug, nom. voltage: 500 V, nominal current: 24 A, number of positions: 4, connection method: Screw connection, Rated cross section: 2.5 mm<sup>2</sup>, cross section: 0.14 mm<sup>2</sup>- 4 mm<sup>2</sup>, color: gray

---

## UPBV 2,5/ 5 - Plug

3045431

<https://www.phoenixcontact.com/us/products/3045431>



Plug, nom. voltage: 500 V, nominal current: 24 A, number of positions: 5, connection method: Screw connection, Rated cross section: 2.5 mm<sup>2</sup>, cross section: 0.14 mm<sup>2</sup>- 4 mm<sup>2</sup>, color: gray

# UT 2,5/1P BU - Feed-through terminal block

3045020

<https://www.phoenixcontact.com/us/products/3045020>

## UPBV 2,5/ 6 - Plug

3045444

<https://www.phoenixcontact.com/us/products/3045444>



Plug, nom. voltage: 500 V, nominal current: 24 A, number of positions: 6, connection method: Screw connection, Rated cross section: 2.5 mm<sup>2</sup>, cross section: 0.14 mm<sup>2</sup>- 4 mm<sup>2</sup>, color: gray

---

## UPBV 2,5/ 7 - Plug

3045457

<https://www.phoenixcontact.com/us/products/3045457>



Plug, nom. voltage: 500 V, nominal current: 24 A, number of positions: 7, connection method: Screw connection, Rated cross section: 2.5 mm<sup>2</sup>, cross section: 0.14 mm<sup>2</sup>- 4 mm<sup>2</sup>, color: gray

# UT 2,5/1P BU - Feed-through terminal block

3045020

<https://www.phoenixcontact.com/us/products/3045020>

## UPBV 2,5/ 8 - Plug

3045460

<https://www.phoenixcontact.com/us/products/3045460>



Plug, nom. voltage: 500 V, nominal current: 24 A, number of positions: 8, connection method: Screw connection, Rated cross section: 2.5 mm<sup>2</sup>, cross section: 0.14 mm<sup>2</sup>- 4 mm<sup>2</sup>, color: gray

---

## UPBV 2,5/ 9 - Plug

3045473

<https://www.phoenixcontact.com/us/products/3045473>



Plug, nom. voltage: 500 V, nominal current: 24 A, number of positions: 9, connection method: Screw connection, Rated cross section: 2.5 mm<sup>2</sup>, cross section: 0.14 mm<sup>2</sup>- 4 mm<sup>2</sup>, color: gray

# UT 2,5/1P BU - Feed-through terminal block

3045020

<https://www.phoenixcontact.com/us/products/3045020>

## UPBV 2,5/10 - Plug

3045499

<https://www.phoenixcontact.com/us/products/3045499>



Plug, nom. voltage: 500 V, nominal current: 24 A, number of positions: 10, connection method: Screw connection, Rated cross section: 2.5 mm<sup>2</sup>, cross section: 0.14 mm<sup>2</sup>- 4 mm<sup>2</sup>, color: gray

---

## UPBV 2,5/11 - Plug

3045509

<https://www.phoenixcontact.com/us/products/3045509>



Plug, nom. voltage: 500 V, nominal current: 24 A, number of positions: 11, connection method: Screw connection, Rated cross section: 2.5 mm<sup>2</sup>, cross section: 0.14 mm<sup>2</sup>- 4 mm<sup>2</sup>, color: gray

# UT 2,5/1P BU - Feed-through terminal block



3045020

<https://www.phoenixcontact.com/us/products/3045020>

## UPBV 2,5/12 - Plug

3045512

<https://www.phoenixcontact.com/us/products/3045512>



Plug, nom. voltage: 500 V, nominal current: 24 A, number of positions: 12, connection method: Screw connection, Rated cross section: 2.5 mm<sup>2</sup>, cross section: 0.14 mm<sup>2</sup>- 4 mm<sup>2</sup>, color: gray

---

## UPBV 2,5/13 - Plug

3045525

<https://www.phoenixcontact.com/us/products/3045525>



Plug, nom. voltage: 500 V, nominal current: 24 A, number of positions: 13, connection method: Screw connection, Rated cross section: 2.5 mm<sup>2</sup>, cross section: 0.14 mm<sup>2</sup>- 4 mm<sup>2</sup>, color: gray

# UT 2,5/1P BU - Feed-through terminal block

3045020

<https://www.phoenixcontact.com/us/products/3045020>

## UPBV 2,5/14 - Plug

3045538

<https://www.phoenixcontact.com/us/products/3045538>



Plug, nom. voltage: 500 V, nominal current: 24 A, number of positions: 14, connection method: Screw connection, Rated cross section: 2.5 mm<sup>2</sup>, cross section: 0.14 mm<sup>2</sup>- 4 mm<sup>2</sup>, color: gray

---

## UPBV 2,5/15 - Plug

3045541

<https://www.phoenixcontact.com/us/products/3045541>



Plug, nom. voltage: 500 V, nominal current: 24 A, number of positions: 15, connection method: Screw connection, Rated cross section: 2.5 mm<sup>2</sup>, cross section: 0.14 mm<sup>2</sup>- 4 mm<sup>2</sup>, color: gray

# UT 2,5/1P BU - Feed-through terminal block

3045020

<https://www.phoenixcontact.com/us/products/3045020>

## UPBV 2,5/ 1 BU - Plug

3045240

<https://www.phoenixcontact.com/us/products/3045240>



Plug, nom. voltage: 500 V, nominal current: 24 A, number of positions: 1, connection method: Screw connection, Rated cross section: 2.5 mm<sup>2</sup>, cross section: 0.14 mm<sup>2</sup>- 4 mm<sup>2</sup>, color: blue

---

## UPBV 2,5/ 1 GNYE - Plug

3045253

<https://www.phoenixcontact.com/us/products/3045253>



Plug, nom. voltage: 500 V, nominal current: 24 A, number of positions: 1, connection method: Screw connection, Rated cross section: 2.5 mm<sup>2</sup>, cross section: 0.14 mm<sup>2</sup>- 4 mm<sup>2</sup>, color: green-yellow

# UT 2,5/1P BU - Feed-through terminal block

3045020

<https://www.phoenixcontact.com/us/products/3045020>

## UPBV 2,5/ 1-L - Plug

3045318

<https://www.phoenixcontact.com/us/products/3045318>



Plug, nom. voltage: 500 V, nominal current: 24 A, number of positions: 1, connection method: Screw connection, Rated cross section: 2.5 mm<sup>2</sup>, cross section: 0.14 mm<sup>2</sup>- 4 mm<sup>2</sup>, color: gray

---

## UPBV 2,5/ 1-L BU - Plug

3045321

<https://www.phoenixcontact.com/us/products/3045321>



Plug, nom. voltage: 500 V, nominal current: 24 A, number of positions: 1, connection method: Screw connection, Rated cross section: 2.5 mm<sup>2</sup>, cross section: 0.14 mm<sup>2</sup>- 4 mm<sup>2</sup>, color: blue



# UT 2,5/1P BU - Feed-through terminal block

3045020

<https://www.phoenixcontact.com/us/products/3045020>

## UPBV 2,5/ 1-L GNYE - Plug

3045334

<https://www.phoenixcontact.com/us/products/3045334>



Plug, nom. voltage: 500 V, nominal current: 24 A, number of positions: 1, connection method: Screw connection, Rated cross section: 2.5 mm<sup>2</sup>, cross section: 0.14 mm<sup>2</sup>- 4 mm<sup>2</sup>, color: green-yellow

---

## UPBV 2,5/ 1-M - Plug

3045347

<https://www.phoenixcontact.com/us/products/3045347>



Plug, nom. voltage: 500 V, nominal current: 24 A, number of positions: 1, connection method: Screw connection, Rated cross section: 2.5 mm<sup>2</sup>, cross section: 0.14 mm<sup>2</sup>- 4 mm<sup>2</sup>, color: gray

# UT 2,5/1P BU - Feed-through terminal block

3045020

<https://www.phoenixcontact.com/us/products/3045020>

## UPBV 2,5/ 1-M BU - Plug

3045350

<https://www.phoenixcontact.com/us/products/3045350>



Plug, nom. voltage: 500 V, nominal current: 24 A, number of positions: 1, connection method: Screw connection, Rated cross section: 2.5 mm<sup>2</sup>, cross section: 0.14 mm<sup>2</sup>- 4 mm<sup>2</sup>, color: blue

---

## UPBV 2,5/ 1-M GNYE - Plug

3045363

<https://www.phoenixcontact.com/us/products/3045363>



Plug, nom. voltage: 500 V, nominal current: 24 A, number of positions: 1, connection method: Screw connection, Rated cross section: 2.5 mm<sup>2</sup>, cross section: 0.14 mm<sup>2</sup>- 4 mm<sup>2</sup>, color: green-yellow

# UT 2,5/1P BU - Feed-through terminal block

3045020

<https://www.phoenixcontact.com/us/products/3045020>

## UPBV 2,5/ 1-R - Plug

3045376

<https://www.phoenixcontact.com/us/products/3045376>



Plug, nom. voltage: 500 V, nominal current: 24 A, number of positions: 1, connection method: Screw connection, Rated cross section: 2.5 mm<sup>2</sup>, cross section: 0.14 mm<sup>2</sup>- 4 mm<sup>2</sup>, color: gray

---

## UPBV 2,5/ 1-R BU - Plug

3045389

<https://www.phoenixcontact.com/us/products/3045389>



Plug, nom. voltage: 500 V, nominal current: 24 A, number of positions: 1, connection method: Screw connection, Rated cross section: 2.5 mm<sup>2</sup>, cross section: 0.14 mm<sup>2</sup>- 4 mm<sup>2</sup>, color: blue

# UT 2,5/1P BU - Feed-through terminal block

3045020

<https://www.phoenixcontact.com/us/products/3045020>



## UPBV 2,5/ 1-R GNYE - Plug

3045392

<https://www.phoenixcontact.com/us/products/3045392>



Plug, nom. voltage: 500 V, nominal current: 24 A, number of positions: 1, connection method: Screw connection, Rated cross section: 2.5 mm<sup>2</sup>, cross section: 0.14 mm<sup>2</sup>- 4 mm<sup>2</sup>, color: green-yellow

---

Phoenix Contact 2023 © - all rights reserved

<https://www.phoenixcontact.com>

Phoenix Contact USA  
586 Fulling Mill Road  
Middletown, PA 17057, United States  
(+717) 944-1300  
[info@phoenixcon.com](mailto:info@phoenixcon.com)