

**Style**  
M12 Socket, shielded  
4 pin  
A-coding

**Ratings**  
Voltage: 250 V  
Current: 4 A

**Operating Temperature Range**  
-40~105 °C

**Materials**  
① Insulator: Polyamide 66 (PA66), UL94 HB, black  
② Pin: C5191 phosphor bronze, gold plated  
③ Shell: C3604 brass, nickel plated  
④ Nut: C3604 brass, nickel plated  
⑤ O-ring: Nitrile rubber, green/black

**Electrical Requirements**  
Dielectric strength: 1 min @ 500 Vac  
Insulation resistance: 100 MΩ @ 500 Vdc  
Contact resistance: 10 mΩ or less

**Mechanical Requirements**  
Life cycle: 500 mating cycles minimum

**Environmental Requirements**  
Salt spray test: 35 °C, relative humidity 90-95%, 5% NaCl mist for 48 hrs. Wash parts after test. Maintain mechanical requirements and a contact resistance of less than 10 mΩ.  
Waterproof: IP67

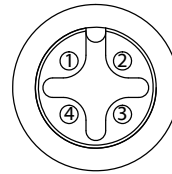

Front View  
Not to Scale

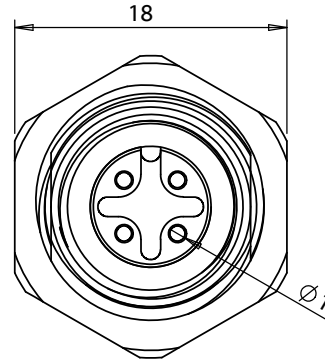

Panel cutout (PG9)  
Panel thickness (4.5mm max.)

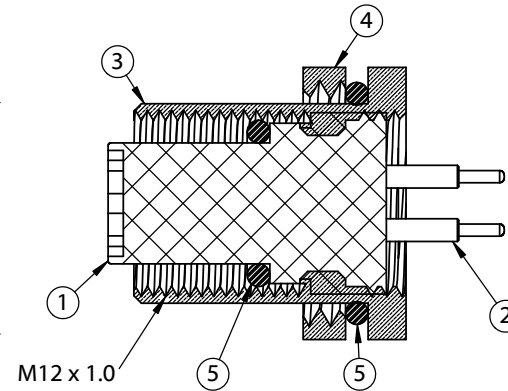
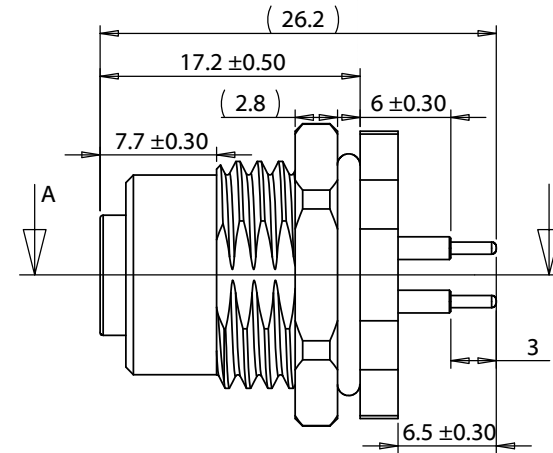
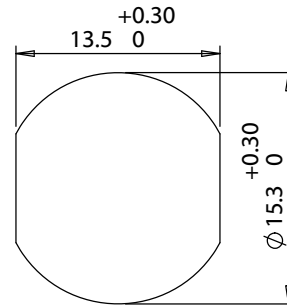

SECTION A-A

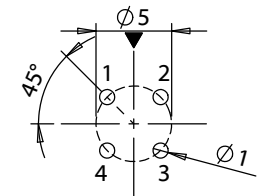
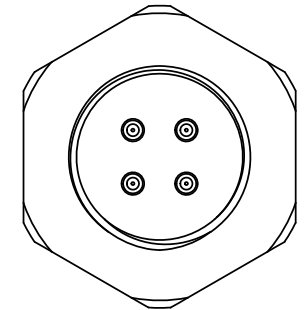
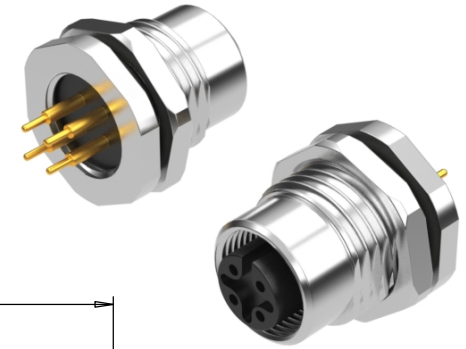

PCB Layout

Revision:	Date:	Description:
A	10/6/2020	Initial release

Prepared:  
JC  
Digitally signed by JC  
Date: 2020.10.23 15:36:38 -07'00'

Verified:  
AG  
Digitally signed by AG  
Date: 2020.10.23 15:47:12 -07'00'

Dimensions are in millimeters.  
Tolerances:  
X: ± 0.3 mm  
X.X: ± 0.1 mm  
X.XX: ± 0.05 mm

Notes:  
RoHS compliant

Function test: no open, no short circuit, no intermittent

Description:  
Connector, 4 pin M12 A-code socket, 12xL26.2mm, gold plated, panel mount, PCB, IP67

**TENSILITY**

tel 1.541.323.3228 800 877.670.7118  
fax 1.541.323.4202 web tensility.com

Size: A Part number: 54-00235

Scale: 2:1

Sheet 1 of 1