

MR8025 series

**(80 x 80 x 25 mm)**

3.15 x 3.15 x 0.98 inches

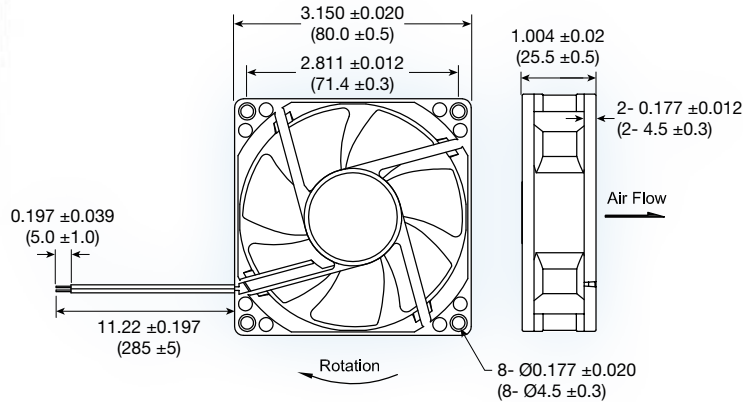
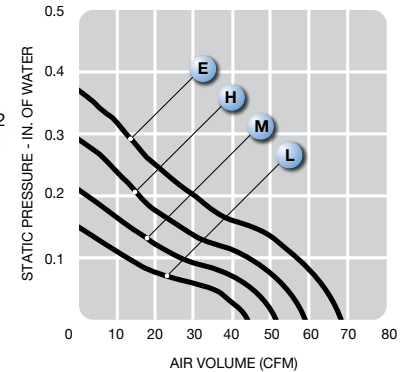

Features: soft start, polarity protection, auto-restart

Operating Voltage: 12 or 24 VDC

Construction: UL94V-0 plastic impeller and frame

Bearing option: ball bearing or sleeve

Air Flow: air exhaust over struts

Options: tachometer output or locked rotor alarm signal; PWM speed control

Model No.	Rated Voltage VDC	Current A		Speed RPM	Air Volume		Max. Static Pressure (H ₂ O)		Sound Noise dba	Weight g
		12	24		M ³ /Min.	CFM	MM	INCH		
MR8025L	12/24	0.20	0.10	3,000	1.22	44	3.77	0.15	31.5	54
MR8025M	12/24	0.22	0.11	3,600	1.46	52	5.37	0.21	38.1	54
MR8025H	12/24	0.31	0.15	4,200	1.70	60	7.25	0.29	41.5	54
MR8025E	12/24	0.40	0.20	4,800	1.93	67	9.42	0.37	44.2	54

